

Lombok-Indonesia. December, 1th-2nd 2016

ICST 2016

The 1st International Conference on
Science and Technology

PROCEEDINGS

“ Emerging Innovation on Science and Technology for Sustainable Development ”

Supported by



ISBN : 978-602-6640-00-0

ISBN : 978-602-6640-00-0

Editor :

Nanda Diniarti, S.Pi., M.Si

Dewi Nur'aeni Setyowati, S.Pi, M.Biotech

Scientific Committe :

1. Dr. Satrijo Saloko
2. Ir. Bambang Hari Kusumo, M.Agr., Sc., Ph.D
3. Made Sriasih, Ph.D
4. Prof. Dr. Anil Kumar A
5. Prof. Ir. Sri Widyastuti, M.App.Sc.,Ph.D
6. Ir. Aluh Nikmatullah, Ph.D
7. dr. Dewi Suryani, M.Infect.Dis

Proceedings

The 1st International Conference on Science and Technology (ICST) 2016

Theme : The Emerging Innovation On Science And Technology

Published by :

Mataram University Press

Jl. Majapahit, No 62 Mataram West Nusa Tenggara, Indonesia 83125

Telp: +62-0370-633007 / Fax: +62-0370-636041

Copyright law protected

Don't to quote, reproduce and translate some or all of these books without the permission of the publisher

PREFACE

Bismillaahirrahmaanirrahiim
Assalaamu'alaikum warahmatullaahi wabarakaatuh.

Praise always we pray to God Almighty for giving us the abundance of grace, guidance and inayah, so that we all can met in the “1stInternational Conference on Science and Technology (ICST) 2016”. ICST is a conference where researchers can share and publish their scientific papers about science and technology. The theme of this conference is “Emerging Innovation on Science and Technology for Sustainable Development”.

This conference was done for two days, from 1st to 2nd December 2016, and took place in the Green Campus of the University of Mataram.

We received more than one hundred papers from various universities and research institutions in Indonesia and from overseas, but not all of the papers were published in this proceeding. The paper has been selected and grouped based on the similarity of the research field, which then are presented and discussed. Presentation of the papers will be held in eight parallel classes.

At this moment, the organizing committee would like to expressour gratitude to all of you who have participated this conference, especially to the all keynote speakers, presenters who have submitted posters or orally presented papers and also to the participants. Our special gratitude also goes to the Rector of the University of Mataram who has been highly supporting this conference. Last but not least, the organizing committee would like to thank to all of you who have supported this conference.

Wassalamu'alaikum warohmatullahi wabarakatuh.

Chairman of 1st ICST 2016

Dr. Satrijo Saloko

The 1st International Conference on Sciences and Technology
December, 1-2, 2016 Mataram, Lombok-NTB, Indonesia

OPENING SPEECH - RECTOR THE UNIVERSITY OF MATARAM The 1st International Conference on Science and Technology 2016

Respected Guests,
Keynote speakers,
Conference participants,
and all other participants.

On Behalf of all staffs of the University of Mataram, I welcome you all to Lombok, a beautiful island in West Nusa Tenggara Province, where the University of Mataram is located. Lombok is known for its natural and cultural diversity where you can enjoy traditional cuisines, beaches, waterfalls, mountain, traditional villages and handicraft of many ethnics including Sasak, Samawa, Mbojo, Balinese, Chinese, Arabic, and many others.

As the Rector of the University of Mataram, it is a great honour for me to address the opening of “The 1st International Conference on Science and Technology” here at the University of Mataram, which will be held from 1th to 2nd December 2016, with a theme “Emerging Innovation on Science and Technology for Sustainable Development”. The main aim of this seminar is to gather scientist from all over the world to share their ideas, knowledge and experiences and to build network for possible future collaboration.

As we are aware that sharing knowledge and experiences from speakers are extremely valuable in a conference, therefore I would like to express my high appreciation, first, to the keynote speakers from overseas and from Indonesia for their willingness to come to Lombok to share their acknowledged works. Your effort and contribution to this conference are absolutely valuable. Second, my high appreciation also goes to the national speakers and all other participants, including the speakers from University of Mataram and local universities in West Nusa Tenggara Province, your participation in this conference not only will give incredible share of ideas, skills and knowledge that

The 1st International Conference on Sciences and Technology

December, 1-2, 2016 Mataram, Lombok-NTB, Indonesia

you have, but also will improve the academic environment that we are developing in this university. I hope this conference will be a good forum, not only for communicating and sharing ideas, knowledge and experiences, but also for building networking for future collaboration.

I would also like to take this opportunity to express my appreciation to the sponsors which have given some contribution to this conference. Last but not least, I would like to thank the organizing committee as well as all other supporters and participants, without their effort, commitment and hard work, this conference will not run well.

Finally, I wish you most successful conference, enjoy Lombok Island and hope to see you again in other forum here at the University of Mataram.

Rector of the University of Mataram

Prof. Ir. Sunarpi, Ph.D

TABLE OF CONTENTS

Title	Page
Preface	i
Opening Speech	ii
Table of Contents	iv
<i>Schemata Detection of Chemistry Teachers Prospective Students After Had Exclusive Conceptual Change Experiencing</i> Kurroti A'yun, Suyono	1-4
<i>Use of The Experimental Board on Kirchhoff's Laws to Train Students Skills in Doing Experiment</i> Hikmawati	5-8
<i>Potential of Abalone (Haliotis sp.) as Control Agent of Biofouling (seaweed) in Mariculture with Cage Nets</i> Dewi Nur'aeni Setyowati, Nanda Diniarti	9-12
<i>Growth Performance Of Kappaphycus alvarezii with Addition of Sargassum sp. Extract Using Spraying Technique</i> Tino Feri Ananta, Nunik Cokrowati, Mursal Ghazali	13-20
<i>Development of e-SCM Open Source as Integration of Data Managemen for Fish Farmers SMEs in Pasar Ulekan Bandung</i> Yudi Priyadi, Jurry Hatammimi	21-27
<i>Seasonal Comparison of Aquatic Macroinvertebrate Benthic were Collected in Powerplant Segment Sidutan Stream, North Lombok</i> Nanda Diniarti	28-30
<i>Economic Analysis of Direct Loan Cattle Dispersal System in Sumbawa District</i> Anggi Fitriza and Hermansyah	31-34
<i>Green Synthesis of Bio-degradable Superabsorbent Polymers from Carboxymethyl Cellulose/Humic Acid</i> Nurul Ismillayli, Siti Raudhatul Kamali, Sapri Hamdiani, Surya Hadi, Dhony Hermanto	35-38
<i>Shear Design of Reinforced Concrete Beam Using Steel Truss Encased in Flexural Plastic Hinge Zone</i> Fatmawati Amir, Iman Satyarno, Djoko Sulisty	39-43
<i>Design of Seismic Recorder with Single-Axis Geophone for Passive Seismic Monitoring</i> I Wayan Sudiarta, Raja Fathurrahman Akmaludin, Dian Wijaya Kurniawidi, Made Sutha Yadnya	44-48
<i>Study of Livestock Behavior Relationship in Cage Environmental Sanitation Management with Suspect of Scabies Disease</i> Mujahid Fitriadi, Sukardono, Made Sriasih	49-52
<i>Characteristics Of Water Inundation In The Swampland Of Pelabuhan Dalam Village (Ogan Ilir South Sumatera)</i> Puspitahati, Edward Saleh, Robiyanto H. Susanto, Ngudiantoro	53-56
<i>Elements Social Capital in The Vegetable Marketing In Tawangargo Village , Malang Regency, East Java</i> Sugeng Riyanto, Kliwon Hidayat, Keppi Sukesi	57-60
<i>Kinetics of Increasing Protein Content on The Sorghum Flour Fermentation</i> Nur Istianah	61-64
<i>Genes Action in Quantitative Traits of Rice The Result of Crosses Between Ipb 4s Varieties With Red Rice Promising Lines</i> Baiq Ernawati, I Gusti Putu Muliarta Aryana, Anak Agung Ketut Sudharmawan	65-68
<i>Behavior of Rice Market in the Lampung Province</i> Irmayani Noer, Bina Unteawati	69-72
<i>Optode Urease Biosensor and Their Application for The Determination of Hg (II) in Aqueous Solution</i>	73-76

Dhony Hermanto, Mudasir, Dwi Siswanta, Bambang Kuswandi	
<i>Inhibitive Determination of Hg (II) in Aqueous Solution Using a Urease Amperometric Biosensor</i> Dhony Hermanto, Mudasir, Dwi Siswanta, Bambang Kuswandi	77-80
<i>Activated Carbon Composites from Rice Husk as an Adsorbent Textile Waste</i> Dian W. Kurniawidi, Cici Andayani, Siti Alaa', Susi Rahayu	81-84
<i>Early Detection of Newborn Hearing Impairment: The Useful of Mobile Application</i> Hamsu Kadriyan, Sapto Sutardi	85-89
<i>Incorporate Computational Chemistry as an Alternative for Chemistry Laboratory Work at High School Level</i> Saprizal Hadisaputra, Lalu Rudyat Telly Savalas, Sapri Hamdiani	90-93
<i>The Application of Giving Various Dose of NPK Manure Toward Tobacco Crop (Nicotiana Tabaccum L.) in Lombok Island West Nusa Tenggara Island</i> Titin Sugianti, Fitria Zulhaedar, Sudjudi	94-101
<i>The Optical Properties of SnO₂ Thin Layer With Dopan Zinc Using Solgel Technique</i> Aris Doyan, Susilawati, Yolanita Septiana	102-105
<i>The Electrical Properties of Barium Hexaferrite Nanopowders Using Co-Precipitation Method</i> Susilawati, Aris Doyan	106-110
<i>Detection of Lombok Faults using Gravity Methods</i> Suhayat Minardi, Teguh Ardianto, Alfina Taurida Alaydrus	111-115
<i>Description of Cognitive Conflict Levels in Chemistry College Students in Conceptual Change Strategy</i> Rosalina Eka Permatasari, Suyono	116-125
<i>Preliminary Study And Synthesis Thin Film of Crystalline Al, Zn Co-Doped SnO₂ (Stannic Oxide) With Sol-Gel Dip Coating Technique</i> Aris Doyan, Norma Ikraman, Susilawati, Syifa Azzahra, Zahid Ramdhan	126-128
<i>Statistical Downscaling Model Using Nonparametric Regression to Predict Temperature in Selaparang Lombok</i> Mustika Hadijati, Desy Komalasari, Nurul Fitriyani	129-132
<i>Preliminary Study and Synthesis Thin Film of Antimony Tin Oxide (ATO) with Sol-Gel Spin Coating Technique</i> Syifa Azzahra, Aris Doyan, Susilawati, Ahmad Harjono, Norma Ikraman, Zahid Ramdhan	133-136
<i>The Identification on Iron Compound of Nature Sand in Ampenan Beach Mataram</i> Annisa Fithriyani, Husniatul Khair, Susilawati, Aris Doyan	137-140
<i>Preliminary Study of Electrical and Magnetic Properties of Barium MHexaferrites from Nature Sand With Co-Ni Substituted by Co-Precipitation</i> Husniatul Khair, Annisa Fithriyani, Susilawati, Kosim, Aris Doyan	141-144
<i>Agro-tourism in North Lombok Stimulates New Crops and Technology Adaptation, and Farming Becomes Profitable</i> Taslim Sjah, Zainuri, Ahmad Sauqi, Jayaputra	145-149
<i>Simulation of the Bubble Gas Detection inside the Fluids based on Transmission and Reflection of Ultrasonic Waves</i> Firyal Dhiyaul Haqqi, Bakti Abdillah, Rahadi Wirawan, Laili Mardiana	150-156
<i>Development of Data Acquisition System of Moving Object for Landslide Monitoring System</i> Rahadi Wirawan, Bakti Abdillah, Wayan Sudiarta, Dian Wijaya Kurniawidi	157-160
<i>Preliminary Study and Synthesis Thin Film Of Fluorine Tin Oxide (Fto) With Sol-Gel Spin Coating Tecnique</i> Zahid Ramdhan, Aris Doyan, Kosim, Susilawati, Syifa Azzahra, Norma Ikraman	161-164
<i>The Livelihood Strategy of Dry Land Farmers in Karang Bayan Village, West Lombok, Indonesia</i> I Ketut Budastra, Taslim Syah, IGL. Parta Tanaya, Suparmin, Halil	165-168

<i>Nonparametric Regression Spline in The Estimation of The Average Number of Children Born Alive Per Woman</i> Nurul Fitriyani, I Nyoman Budiantara, Ismaini Zain, Vita Ratnasari	169-172
<i>Development Elements of Industrial Production Increase in Productivity Of Micro / Small (Export Oriented Product) for Enhancing Competitiveness of Industry [Case Study: In Lombok-NTB]</i> I G.A.K Chatur Adhi Wiryra Aryadi, I Made Wijana, I Wayan Joniarta	173-176
<i>Study of Maize-Pulses Intercropping on a Dryland</i> I K. D. Jaya, Sudirman, H. Suheri	177-180
<i>The Performance of Production and Price of Rice In South Sumatra</i> Desi Aryani	181-184
<i>Growth Performance of Broiler Chickens Fed Diets Containing Putak and Rice Bran Supplemented With Cellulase, Xylanase, B-Glucanase, Pectinase, Phytase, Protease and Amylase</i> Nalle Catootjie Lusje, Netty Ermawatty, Marlin R. K. Yowi, Defrys R. Tulle	185-190
<i>Growth Performance of Red Rice as Affected by Insertion of Peanut Row between Double and Triple-Rows of Rice in Aerobic System on Raised-Beds</i> Nihla Farida, Hanafi Abdurrachman, V.F. Aris Budianto, Wayan Wangiyana	191-196
<i>Improving Growth and Bulb Production of Several Varieties of Shallot through Mycorrhiza Inoculation and Growing Peanut Plants Inserted between Double-Rows of Shallot (Allium ascalonicum L.)</i> Wayan Wangiyana, I Komang Damar Jaya, I Gde Ekaputra Gunartha, Sunarpi	197-201
<i>Skill of Warige as A Seasonal Climate Forecast in Lombok, Indonesia</i> Ismail Yasin, Mahrup, Mansur Ma'shum, Sukartono, Husni Idris	202-206
<i>Simple Solar Desalination for Seawater at Kec. Bayan Kab. Lombok Utara</i> Dhony Hermanto, Nurul Ismillayli, Siti Raudhatul Kamali, Fahrurazi	207-210
<i>Production of Lentinula edodes (Shiitake mushrooms) on inoculated logs of a range of tree species</i> Irwan Mahakam Lesmono Aji	210-215
<i>Shear Analysis And Design of Reinforced Concrete Interior Beam Column Joint Using King Cross Steel Profile</i> Rahmani Kadarningsih, Iman Satyarno, Muslikh, Andreas Triwiyonono	216-219
<i>Polytomous Logistic Regression in Analyzing the Presence of National Pilot Mosque in Karang Baru Mataram, 2016</i> Nurul Fitriyani, Lailia Awalushaumi, Agus Kurnia	220-223
<i>Shear Capacity Of Hybrid Coupling Beam</i> Nursiah Chairunnisa, Iman Satyarno, Muslikh, Akhmad Aminullah	223-227
<i>The Modification and Analyzing of heat Loss of The Heater System in The Knockdown Fumigator Type</i> M. Munandar Prayuda, Sukmawaty, Guyup Mahardhian D.P.	228-233
<i>Design of Seismic Recorder with Single-Axis Geophone for Passive Seismic Monitoring</i> I Wayan Sudiarta, Raja Fathurrahman Akmaludin, Dian Wijaya Kurniawidi, Made Sutha Yadnya	234-238
<i>Zinc Supply and Root Pruning on Growth and Relative Zinc Absorption Rate by Transplanted Rice (Oryza sativa L.)</i> Mulyati	239-246
<i>Making Learning Media of Statistical Physics Course Using The Internet Offline Browser for Physics Students in PMIPA FKIP of Mataram University</i> Muhammad Taufik, Aris Doyan, Susilawati, Gunawan	247-250
<i>Potential for Mass Rearing of the Egg Parasitoids, Ooencyrtus malayensis and Hadronotus leptocorisae (Hymenoptera: Scelionidae) on Nezara viridula Eggs</i> Aisah Jamili, Yen Kusnita	251-254
<i>Factors Related to Stunting in Children Aged 24-59 Months in Narmada Public Health Care</i>	255-259

Lina Nurbaiti, IDGN Agung, Umara Lani Anika, Arina Windri Rivarti, Dimas Pambudi Prakoso, Nabila Fawzia Putri, Nanda Retno Wardhani, Agus Gowinda Amijaya, Andri Irfan	
<i>The Effect Of Shape And Number Of The Tube Of A Flat Plate Solar With A Gravel Absorber On Heat Transfer Rate And Collector Efficiency</i> Made Wirawan, Mirmanto	260-263
<i>Waters Carrying Capacity for Developing Spiny Lobster Farming using Phosphorous Budget Approach in Ekas Bay, West Nusa Tenggara</i> Muhammad Junaidi	264-267
<i>Immobilization of TiO₂ on Coal Bottom Ash and Its Activity Test as A Photocatalyst in Degradation of Methylene Blue Dye</i> Tuty Alawiyah, Nurul Hidayat, Endang Tri Wahyuni	268-272
<i>Design of Low Frequency Vibration Generator As Seismic Sensor Calibrator with Optocoupler Counter</i> Yulkifli, Rahadi Wirawan, Yoggy Refiyon	273-278
<i>Measuring and Mapping Carbon and Nitrogen in Indonesian Tropical Soil using Rapid Technique of Near Infrared Technology</i> B.H. Kusumo, Sukartono, Bustan, C.W.H. Anderson, C.B. Hedley, M.J. Hedley, M. Camps Arbertain	279-287
<i>Correlation Between Waist/Hip Ratio And Lipid Profile Of Lactovegetarian Community In West Lombok</i> Ardiana Ekawanti, Agnes Ragil Rosano	288-291
<i>Isolation of Andrographolide from Andrographis paniculata</i> Aliefman Hakim, Dwi Laksmiwati, I Nyoman Loka, Sarifa Wahida Al Idrus, Try Setyaningsih, Supriadi	292-295
<i>The Use of 1-Mcp: Overview Several Studies on The Postharvest Quality of Selected Fruits</i> Liana Suryaningsih B, John K. Fellman, James P. Mattheis, Xisheng Sun	296-299
<i>Design Of The Measuring Instrument Of Turbidity Level Using Turbidity Sensor Based on SMS Gateway</i> Lily Maysari Angraini, Laili Mardiana, Kasnawi Al Hadi, Eka Ahmawati	300-307
<i>The Identification of Agroforestry System Plants as Raw Ingredients/Materials for Herbal Soap in Sesaot Forest</i> Indriyatno, Wiharyani Werdiningsih, I Gde Mertha	308-310
<i>Growth an Yield of Onion (Allium Cepa Var. Ascalonicum) as CA Result of Addition of Biocompost and Boactivity Fermented with Trichoderma spp.</i> I Made Sudantha, Suwardji	311-316

Schemata Detection of Chemistry Teachers Prospective Students After Had Exclusive Conceptual Change Experiencing

Kurroti A'yun¹, Suyono²

¹Doctoral Program of Science Education Faculty, State University of Surabaya (Unesa), Indonesia

² State University of Surabaya (Unesa), Indonesia

* Email: ayun_tlits99@yahoo.com

Abstract

Chemistry student teachers found that they still have misconceptions with high load (over 50%) of the observations using misconceptions detection, in particular on the concept of solution. To explore the behavior of students in the process of conceptual change, mixed method research method is used, the design of this research is embedded concurrent. There is triangulation method in this study, but the more dominant qualitative method used in this study is quantitative method. This article was created by the author to discuss the observations of the two students who have learning style characteristics sequential-global balanced and moderate levels of cognitive conflict on the concept of conductivity of the solution and bases of Arrhenius. Two students were reduced misconceptions with conceptual change strategies and reinforcement conception by doing peer learning. Analytical results from this study indicate that two students were studied, hold a strong enough its conception, so it is necessary to experience for at least twice cognitive conflict condition and strengthening their conception after the process of conceptual change through peer learning. Additionally, showed that students research subjects experienced anxiety is high enough when he learned he suffered a misconception on the category easy concept, so it takes longer to get through accommodation stage, appealed the assimilation stage. Need to detection to ensure conception has obtained a student has entered the long-term memory. This article has not yet discussed the long-term memory retention of students.

Keywords: *embedded concurrent, misconception, conceptual change, peer learning, qualitative.*

1. Introduction

Students who have high levels of cognitive conflict (TKK) moderate to high not supposed to have a high burden of misconceptions, even should not experience any misconceptions. The statement was supported by the research of Lee et al. (2003), for students who have a high TKK will be faster reaction to find out and fix the conception is still wrong. According Tekkaya and Geban (2001), as well as Wandersee, Mintzes & Novak (1994), misconceptions is very difficult to change and difficult to remove, if students are not resilient or do not immediately want to change his conception. Students who have low TKK, often indifferent to information that is not in accordance with the schemata owned. Therefore, it is often too low TKK students with the little conflict or no conflict when receiving different information with skematanya. This leads to more frequent and more students misconceptions detected.

Students with learning styles sequential-global balanced found to skew experiencing misconceptions (A'yun, 2016). Students with learning styles sequential-global balanced by Felder and Brent (2005), students will learn the concepts sequentially, but presented a concept that has been understood by understanding hopping. In addition, the student's learning style

sequential-global balanced less able to understand the logical reasons concepts are studied and are less able to connect the concepts learned with other concepts that have relevance to the discussion. Students with learning styles sequential-global balanced slow to understand a concept, because students need a thorough explanation for a concept and connect it with less exposure owned prior knowledge that is not necessarily true. Students with learning styles sequential-global balanced experiencing misconceptions can turn into kindergarten, but tends to return to the Court, because the student's understanding of learning style sequential-global balanced this piecemeal and jumping (not in order).

In the process of learning the teacher will transfer their knowledge to students. In this process if the teaching styles of teachers match students who have learning styles that students will tend to pay attention, otherwise the students tend to ignore (Felder, 1993). The teaching styles according to Felder-Silverman model that can be applied to facilitate sequential-global learning styles balanced of students in outline by Pritchard (2009) is lead students to be focus on the logical flow of material and make connections to other lessons, topics and everyday experiences.

2. Materials and Methods

The participants of this study are chemistry student teachers in Indonesia, actually in Unesa in 7th semester programs. There are 88 students we arranged to answer the learning style test (LST), cognitive conflict test (CCT), and detection test of misconceptions. The sample was chosen purposely from a class and all students participated in the study voluntarily. All of the 88 participant students answered a complete package of learning styles test and test misconceptions, but only 49 students answered the test cognitive conflict. Before identifying characteristics of study participants, we select the participants. We chose the participants based upon purposive sampling, those are we decided that the participants are suitable for our study is the prospective student chemistry teacher last semester, especially the students of 7th semester. Participants were selected with consideration of their sustainability research into misconception remediation program based on the specific characteristics of student misconceptions, especially are learning styles, levels of cognitive conflict and misconceptions load experienced by the students.

After having an obtained of student, who has individual characteristics such as high-load misconceptions, learning styles sequential-global balanced and TKK, the students would carried reduction misconceptions program. Reduction of misconceptions program in this research, conducted using an exclusively (individually) conceptual change strategies. Those exclusive way, because the researcher hoping the obtained results and the strong (steady) retention of conception, so that the students with correct conception is not easily shaken (turn out to be wrong again). Devices used for this reduction program in the form of work sheet that contains a series of conceptual change stages which is integrated with peer learning in the final stages. After receiving these misconceptions reduction program, the students will be analyzed their body language, gesture, and answer sheet work written for their schemata measured.

3 Results and Discussion

From the text of Faizah answer, body language, gestures, and voice that is displayed on the student's understanding of the reconstruction phase, Nur Faizatul Hilmiyah can be said to have a truly want to change her conception from misconception (MK) to know conception (TK). Faizah anxiety levels decreased, proved movement that revealed only a few movements crossed his legs and shook the chair at the time work on the problems of (Worksheet for

Conceptual Change that integrated with Peer Learning) WCCPL, wiping her nose and mouth, and writing. According to Pease and Pease (2004) and Givens (2002), when a person commits a movement (body language) This means that someone is controlling emotions or defending something inside. This signs of controlling emotion rather Faizah's way to store new information or maintain the retention of new information, instead of maintaining the initial conception before doing WCCP. This is evidenced from Faizah's answers on each question correctly (Faizah's not use the false conceptual answer or early conceptual reasons). The mark of wiping his nose and mouth, does not mean pretending or hiding something truth from her self, but Faizah was trying to accept conceptual description of WCCPL on the reconstruction phase of the student's understanding.

Faizah's repeatedly body movements is calmer when in equilibration phase. According to Glasserfeld (1974), this behavior is calm repeatedly performed is a hallmark of the condition of someone who experienced assimilation. Additionally, Faizah's movement seem more fewer in equilibration phase. According to Quinton, Buisson, and Perotto (2006), the successive activities decreased, but not significantly, this is seem that the person is in the assimilation phase. Based on these statements, Faizah has been completely assimilated with the concept of experts, as evidenced from at least kind of movements are performed.

At peer learning time, Faizah appear calm when explain the conception of its associated conductivity of the solution, but it still needs help inducement sentence of lecturers. In general, Faizah had a steady conception on conductivity of the solution concept, proven to matters done in the reconstruction phase of student understanding and stuffing preparation peer learning all answered well enough. Moreover, when describing the experience no awkwardness during the speech. At peer learning time, Ina (Ina Ana Nuri's nick name) seemed surprised to learn he suffered a misconception, and after listening to the explanation of Faizah, Ina appeared agitated body language, which is characterized by sounding his fingers for 10 seconds. Moreover, the gesture seemed of Ina's self mean that she experienced discomfort with Faizah's conception. After being given additional information, Ina finally willing to accept Faizah's (TK) conception. Ina takes longer for accommodation her schemata, rather than assimilation her schemata.

Acknowledgements

The author would like to thank Prof. Suyono, M.Pd., as a mentor dissertation, so I finished the research and completing articles of this International conference. In addition, the authors also thank to LPDP that has funded dissertation research and travel researchers to followed this International conference.

References

- [1] A'yun, Kurroti. *Pembelajaran Remedial untuk Mereduksi Miskonsepsi Mahasiswa Calon Guru Kimia melalui Strategi Conceptual Change Terintegrasi dengan Conceptual Log dan Peer Learning*. Proposal Disertasi. Sura'baya: Pascasarjana Unesa, 2016, pp. 19-89. (not published)
- [2] Ernst von Glasersfeld. *Piaget and the Radical Constructivist Epistemology In: Smock C. D. & Glasersfeld E. von* (eds.) *Epistemology and education*. Follow Through Publications, Athens GA: 1-24. Piaget and the Radical Constructivist Epistemology, 1974, pp. 10-12.
- [3] Felder, Richard M & Brent, Rebecca. *Understanding Student Differences*. Journal of Engineering Education, 94 (1), 2005, pp.4-6.
- [4] Felder, Richard M. (1993). *Reaching the Second Tier: Learning and Teaching Styles in College Science Education*. J. College Science Teaching, 23(5), 1993, pp.286-290.
- [5] Givens, David B. *The Nonverbal Dictionary of Gestures, Signs & Body Language Cues*. Spokane, Washington: Center for Nonverbal, 2002, pp.10-523.

- [6] Lee, Gyounggho, Kwon, Jaesool, Park, Sang-Suk, Kim, Jung-Whan, Kwon, Hyeok-Gu, & Park, Hac-Kyoo. (2003). *Development of An Instrument for Measuring Cognitive Conflict in Secondary-Level Science Classes*. *Journal of Research in Science Teaching*. Vol. 40, NO.6, 2003, pp.585–603.
- [7] Pease, Allan & Pease, Barbara. *The Definitive Book of Body Language*. Published in Australia by: Pease International, 2004, pp. 25-404.
- [8] Quinton, Jean Charles, Buisson, Jean Christophe, and Perotto, Filippo. *Anticipative Coordinated Cognitive Processes for Interactivist and Piagetian Theories*. University of Toulouse (INP/ENSEEIH), IRIT (Computer Science Research Institute of Toulouse). Toulouse Cedex, France, 2006, pp. 8-12.

Use of The Experimental Board on Kirchhoff's Laws to Train Students Skills in Doing Experiment

Hikmawati

Physics Study Program, Mathematics and Natural Science Education Department, Faculty of teacher Training and Education

Majapahit street No.62 Mataram, 83125, West Nusa Tenggara, Indonesia

hikmawati.fisika@yahoo.com

Abstract

The experimental board on Kirchhoff's Laws is a three-dimensional media used in teaching physics to help students understand the concept of Kirchhoff's Law. Use of this experimental board in the classroom can be applied through the implementation of inquiry-based learning model. Skills of students who can be trained in conducting experiments Kirchhoff's Law through the use of experimental board is the ability to assemble a tool, the ability to read gauges, ability to record observational data, and the ability to present the results of the experiment.

Keywords: *experimental board, Kirchhoff's Law, skills.*

1. Introduction

Learning media is one component of the learning device to be prepared by the teacher as part of lesson planning. Learning media can be a means of liaison between teachers and students so that learning objectives expected to be achieved. According Sukiman (2012), medium of learning is anything that can be used to deliver a message from the sender to the receiver so stimulating thoughts, feelings, concerns and interests as well as the willingness of students so that learning occurs in order to achieve the learning objectives effectively. Sudjana & Rivai (2013) states that there are four types of learning media namely: media two-dimensional, three-dimensional media, media projections, and the environment. The media three-dimensional as one type of learning media can be a model, which is a clone of three dimensional of some real object that is too big, too far, too small, too expensive, too little, or too complicated to be brought into the classroom and students studied in the form of original.

Krajcik (2015) said that developing a classroom culture that focuses on students using the three dimensions to make sense of phenomena or find solutions to problems will initially be challenging. Many teachers haven't been prepared for this type of teaching, and there are not many resources that can give us direction. However, persisting in this endeavor has its advantages. First, all students will develop deeper knowledge of the three dimensions, which will allow them to apply their knowledge to new and more challenging areas. Second, as all students engage in figuring out phenomena or solutions to problems, they will also develop problem-solving, critical-thinking, communication, and self-management skills. Third, and perhaps most importantly, three dimensional learning will help foster all students' sense of curiosity and wonder in science. "I wonder how ... ?" and "How might ... ?" are extremely important questions that have largely disappeared from science classrooms. Three-dimensional learning brings the focus back to curiosity and wonderment, and it can support all students in developing a deeper and more useable knowledge of science.

Board experiments on Kirchhoff's Law is a three-dimensional media used in teaching physics to help students understand the concept of Kirchhoff's Law. Use of this experiment

boards in the classroom can be applied through the implementation of inquiry-based learning model. Skills of students who can be trained in conducting experiments Kirchhoff's Law through the use of experimental board is the ability to assemble a tool, the ability to read gauges, ability to record observational data, and the ability to present the results of the experiment.

2. Discussion

Three-dimensional media is a potential alternative to improve the quality of teaching physics in high school. In other words, three-dimensional media is one of the media that can be a way for teachers to facilitate students in learning. Implementation of the three-dimensional media such as Kirchhoff's Law experiment board in the classroom can use inquiry-based learning model.

The Inquiry Based Learning (IBL) very influence the experiment group in terms of students' achievement reasoning ability. Although the IBL has a positive influence on students' reasoning ability by differences in the average score reasoning ability, but these differences cannot implemented optimally. Considering half of the total number of students in the experimental class scores that were around the average score, where students who have the reasoning ability scores around the average score qualified as fair. On the other hand, the percentage of students who qualified as fair of reasoning ability in the experimental group is almost equal to the total percentage of the control group. Students are seemingly unfamiliar with given IBL worksheet. The worksheet used primarily practicum, presenting all the steps that must be done in detail, such as what to use and how to perform a procedure. So that students will tend to follow the steps in the worksheet. The worksheet used in IBL for trial activity requires them to understand the problem with finding information known and to be known from a given problem. Furthermore, students are also required to be able to design measures that will be used to apply the concepts that have been studied to provide an explanation or make conclusions. Then students must also undertake the elaboration by seeking alternative explanations as well as to evaluate the implementation process of inquiry which is carried out, so that students can build their knowledge through the process of inquiry to the topics investigated in the learning process (Damawati & Juanda, 2016).

Calls for reform in university education have prompted a movement from teacher- to student-centered course design, and included developments such as peer-teaching, problem and inquiry-based learning. In the sciences, inquiry-based learning has been widely promoted to increase literacy and skill development, but there has been little comparison to more traditional curricula. In this study, we demonstrated greater improvements in students' science literacy and research skills using inquiry lab instruction. We also found that inquiry students gained self-confidence in scientific abilities, but traditional students' gain was greater –likely indicating that the traditional curriculum promoted over-confidence. Inquiry lab students valued more authentic science exposure but acknowledged that experiencing the complexity and frustrations faced by practicing scientists was challenging, and may explain the widespread reported student resistance to inquiry curricula (Gormally, et.al., 2009). Smallhorn, et.al. (2015) said that increasing the opportunity for students to be involved in inquiry-based activities can improve engagement with content and assist in the development of analysis and critical thinking skills.

Implementation of inquiry-based learning to teach Kirchhoff's Law in physics learning can be helped with the use of Experiment Board. According to Mukhituly (2016), there evidence which is based on the fundamental principles of the law of Kirchhoff taken as experimental. Definitions and mathematical formulas of named laws correspond to theory and practice of their application. It's offered to name Kirchhoff laws as the first and second

equations. The first law of Kirchhoff is decided to formulate as "algebraic sum of currents converging in the node of electric circuit is equal to zero", and written as formula $\sum I=0$. Practice shows that students often find it difficult to write the formula for a particular current, and sometimes even say that there is no current electricity in the node. This makes sense, because in formula $\sum I=0$ is written that the current is equal to zero and also there are no limits for sum. As a rule the sum in low limit must be specified as 0 or 1, which would mean the sum of universality. But the record of zero does not make sense and record of unit will lead to the absurd, i.e. "there is one current, but it is equal to zero." Therefore, the formula $\sum I=0$ of the first Kirchhoff's law in such recording is not quite mathematically and implicitly rigorous. The second law of Kirchhoff as experimentally was made, in most cases can be recorded as $\sum RI = \sum E$.

Practical work is inseparable part of physics education and nothing will probably change that. There are many goals that are believed to be achievable with it. However, including practical work blindly into the lessons can be contra productive. Every science lab or experiment has to be well thought through and planned with particular goal in mind otherwise it might become giant waste of time and resources. In order to better evaluate the effectiveness of the various methods that experiments can use I have designed a questionnaire that measures students memory retention of them. This will hopefully prove to be useful tool for measuring the effectiveness of practical work (Havlík, 2015).

In order that students can develop researching, questioning, critical thinking, problem solving and decision making skills, so that they become lifelong learning individuals, they should be improved regarding their knowledge, understanding and attitude towards natural sciences. Attitudes towards physics lessons and physical experiments of high school students have been examined for this purpose (Boyuk, 2011). Historically there have been many claims made about the value of laboratory work in schools, yet research shows that it often achieves little meaningful learning by students. One reason, among many, for this failing is that students often do not know the "purposes" for these tasks. By purposes we mean the intentions the teacher has for the activity when she or he decides to use it with a particular class at a particular time. This we contrast with the "aims" of a laboratory activity, the often quite formalized statements about the intended endpoint of the activity that are too often the "opening lines" of a student laboratory report and are simply the "expected" specific science content knowledge outcomes not necessarily learnt nor understood (Hart, et.al., 2000). In spite of the best efforts of teachers, typical students are also learning that physics is boring and irrelevant to understanding the world around them. Many college teachers today want to move past passive learning to active learning, to find better ways of engaging students in the learning process. But many teachers feel a need for help in imagining what to do, in or out of class that would constitute a meaningful set of active learning activities. So we need to change science education to make it more attractive and relevant for a much larger fraction of the student population than in the past (Izadi, 2012).

Skills of students who can be trained in conducting experiments Kirchhoff's Law through the use of experimental board is as follows. The ability to assemble a tool, which is exactly the same circuit and right as in the Student Worksheet. The ability to read gauges, which did parallax errors and using the tool of the greatest range. Ability to record data observations, including data exactly as expected and consistent with the value of uncertainty. Ability to present the results of the experiment, which is presented in accordance with the data obtained, presented in a way that is polite, give another group a chance to express their opinions.

Kirchhoff's Law Experiment board is equipped with a working guide Student Worksheet be used to conduct an investigation or problem-solving activities that facilitate students in the implementation of learning activities. Thus, students will gain experience of

learning in the learning process that includes observing, ask, gather information, associates, and communicate. The components consist of a student worksheets: the title of the experiment, the experimental goals, tools and materials, formulation of the problem, hypothesis, variables, operational definitions of variables, steps experimentation, observation data, data analysis, and conclusions. Kirchoff's Law Experiment board is equipped with a guide in the form of worksheets students are expected to be one of the alternative media to facilitate students learn the concepts of physics so that the learning objectives can be achieved.

To provide learning experiences to students, teachers can make sheets of experiments that can help students find themselves on: the effect of a series of branching to the potential difference (V); and the effect of the strong branching circuit current (I). One set of boards Experimental Law Kirchoff consists of Board Experiments are made of acrylic glass that has been assembled for connecting electrical circuits, with appropriate equipment and materials such as 3 pieces multimeter, 2 pieces of 9 V battery, two sets of resistors (each 3 pieces) resistor the known value of the obstacles, the circuit connecting cable (jumper), cable clamp Resistor.

3. Conclusion

Based on the above it can be concluded that the use of the experimental board on Kirchoff's Laws in teaching physics in high school can apply through inquiry-based learning model. Skills students in the experiment can be trained through the use of experimental board Kirchoff's Law, among which are: the ability to assemble a tool, the ability to read gauges, ability to record observational data, and the ability to present the results of the experiment.

References

- [1] Boyuk, H. K. ve U. 2011. Attitude Towards Physics Lessons And Physical Experiments Of The High School Students. *European J of Physics Education*. Vol.2 Issue 1.
- [2] Damawati, N. A. C. & Juanda, E. A. (2016). The Effect Of Inquiry Based Learning On The Reasoning Ability Of Grade VII Students About Heat Concept. *Jurnal Pendidikan Fisika Indonesia*. 12 (1), 19-25.
- [3] Gormally, C., Brickman, P., Hallar, B., Armstrong, N. (2009). Effects of Inquiry-based Learning on Students' Science Literacy Skills and Confidence. *International Journal for the Scholarship of Teaching and Learning*. Vol. 3 (2), Article 16.
- [4] Hart, C., Mulhall, P., Berry, A., Loughran, J., Gunstone, R. 2000. What is the Purpose of this Experiment? or Can Students Learn Something from Doing Experiments?. *Journal of Research In Science Teaching*. Vol. 37, No. 7.
- [5] Havlí ek, K. (2015). Experiments in Physics Education: What do Students Remember?. *WDS'15 Proceedings of Contributed Papers — Physics*, 144–148.
- [6] Izadi, D. (2012). Physics Education and PYPT. *Physics Competitions*. Vol.13 No.2, 2011 & Vol.14 No.1, 2012.
- [7] Krajcik, J. (2015). *Three-Dimensional Instruction: Using a new type of teaching in the science classroom*. Michigan: Michigan State University.
- [8] Mukhituly, M., I. 2016. Laws or Equality. *International Journal of Education and Research*. Vol. 4 No. 1.
- [9] Smallhorn, M., Young, J., Hunter, N., Silva, K. B. (2015). Inquiry-Based Learning to Improve Student Engagement in a Large First Year Topic. *Student Success*. Volume 6, Issue 2, pp. 65-71.
- [10] Sudjana, N., & Rivai, A. 2013. *Media Pengajaran (Penggunaan dan Pembuatannya)*. Bandung: Sinar Baru Algensindo.
- [11] Sukiman. 2012. *Pengembangan Media Pembelajaran*. Yogyakarta: Pustaka Insan Madani.

Potential of Abalone (*Haliotis* sp.) as Control Agent of Biofouling (seaweed) in Mariculture with Cage Nets

Dewi Nur'aeni Setyowati^{1*}, Nanda Diniarti¹

¹*Aquaculture Study Program, University of Mataram, Pendidikan street no. 37, Mataram, West Nusa Tenggara, Indonesia*

* Email: dewinshuda@yahoo.com

Abstract

Biofouling is a collection of organisms on the surface of object or material in ocean that can be harmful. Biofouling accumulation is being a problem in aquaculture with cage nets in the world. Seaweed is one of biofouling organism in aquaculture with cage nets. Abalone is a species that can use seaweed as food for its live. The aims of this research were to identify biofouling in cage nets and to know the growth and survival rate of abalone which use biofouling (seaweed) as feed. The research was conducted in Ekas Bay, East Lombok for 3 weeks from August until September 2014. The method used were biofouling identification based on www.seaweedbase.com, and descriptive analysis for the growth and survival rate of abalone. The result showed that species of seaweed as biofouling are *Padina australis*, *Gracilaria* sp., *Eucheuma spinosum*, *Hypnea cervicornis*, *Sargassum* sp., *Eucheuma edule*, dan *Rhodomenia palmate*. Abalone could use biofouling (seaweed) to support the growth rate (0,291%) and survival rate (90,266%).

Keywords: *abalone, biofouling, seaweed, cage nets*

1 Introduction

Biofouling is a collection of organisms on the surface of objects or materials in the ocean that can be harmful. Biofouling organisms can be found in the form of microorganisms, plants, and animals (Hartl *et al.*, 2006).

Biofouling accumulation is being a problem in aquaculture with cage nets in the world (Bloecher *et al.*, 2013; Pudota, 2011). Problems caused by biofouling on cultivation of marine waters including the need to charge more for the maintenance of nets and operational, production decreased due to water quality decline due to biofouling, as well as competition biofouling organisms with organisms cultured (Jackson, 2008; Swain and Shinjo, 2014)

At cultivation in cage, to remove biofouling are traditionally done with nets drying. The nets drying is done periodically to remove fouling sticking to the web. In addition, the modern way is done by coating the net with anti-fouling materials (eg cuprous oxide) (Forster, 2013). Economically, it would increase the operational costs of the cultivation in cage.

Abalone is a species that utilize *Gracilaria* sp. as the main feed. *Gracilaria* is one kind of seaweed that becomes biofouling in marine aquaculture. Therefore, the cultivation of abalone as controlling biofouling on cultivation system KJA needs to be done. The study aims to identify the seaweed as biofouling in cage and know the growth and survival of abalone that feed by biofouling (seaweed).

2. Materials and Methods

The research was conducted in the Ekas Bay, East Lombok for 3 weeks on August-September 2014. The method used in the study was the identification of biofouling in cage based on the data in www.seaweedbase.com; and descriptive analysis on the growth and

survival rate of abalone.

The tools used in this research is the cage nets, digital scales, a ruler, a digital camera, the pipe for shelter of abalone. Materials used were abalone seed with size 11-18 g of weight and 4.1 to 5.1 cm of long, and seaweed (*Gracilaria* sp.) as feed of the abalone. During maintenance, observation of growth and survival rate were done.

Calculation of absolute growth of the weight was using a formula of Effendie (1997) as follows:

$$b = W_t - W_o$$

with b namely absolute of the weight, W_t is the average weight of abalone at the end of the observation, and W_o is the average weight of abalone at the beginning of the observation. Absolute growth of the length was calculated using Effendi (1997) as follows

$$b = L_t - L_o$$

where b is the absolute growth of the length, L_t is the average length of abalone at the end of the study, and L_o is the average length of abalone at the beginning of the study.

The calculation of the specific growth rate of the length was using the formula of Weatherley (1970) as follows:

$$g = \frac{(\ln Y_T - \ln y_t)}{(T - t)} \times 100\%$$

with Y_t is length or weight (at time T), y_t is long or initial weight (at time t), e is the base of logarithm natural, and g is the specific growth rate.

Survival is calculated using the formula Effendie (1997) as follows:

$$SR = \frac{N_t}{N_o} \times 100\%$$

with SR namely survival rate (%), N_t is the number of abalone at the end of the observation (individual), and N_o is the number of abalone in the initial observation (individual).

3. Result and Discussion

The results showed that biofouling in the form of macroalgae / seaweed commonly found in floating cages, Ekas Bay (Figure 1). Seaweed as biofouling were identified namely *Padina australis*, *Gracilaria* sp., *Eucheuma spinosum*, *Hypnea cervicornis*, *Sargassum* sp., *Eucheuma edule*, and *Rhodimenia palmata* (Figure 2). Seaweed which dominant in aquaculture nets in the Ekas Bay is *Gracilaria* sp. The domination of *Gracilaria* sp. because this seaweed widely used as a shelter on lobster in the Ekas Bay. Utilization of *Gracilaria* sp. as a shelter due to the type of seaweed that is abundant and easily obtained in the Ekas Bay.



Figure 1. Biofouling (seaweed) on cage nets in Ekas Bay

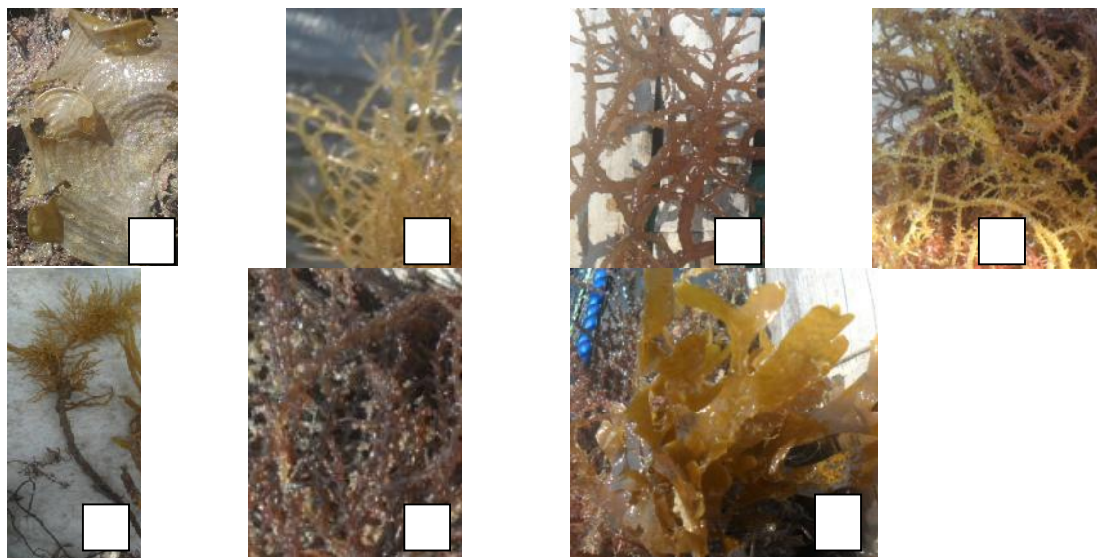

Figure 2. Identification result of seaweed as biofouling in cage nets, Ekas Bay (a) *Padina australis*, (b) *Gracilaria* sp., (c) *Eucheuma spinosum*, (d) *Hypnea cervicornis*, (e) *Sargassum* sp., (f) *Eucheuma edule*, (g) *Rhodimenia palmata*

The results showed that seaweed, particularly *Gracilaria* sp. as biofouling has the potential to feed the abalone. Research of Sholihan (2013) also showed that abalone is more like seaweed (*Gracilaria* sp.) as feed compared with the pellet feed wet by probiotics, abalone growth is also better. Research of Kirkendale *et al.* (2010) in Australia also shows that abalone can consume seaweed like *Gracilaria* sp., *Gelidiaceae*, *Ecklonia radiata*, *Macrocystis augustifolia*, and *Ulva* sp. But the results of these studies show that seaweed preferred by abalone and showed very good results cultivation is *Gracilaria* sp. In this research, *Gracilaria* sp. given only at the first time during the cultivation. After that abalone are not given additional feed. The results showed that the abalone can growth even without the addition of *Gracilaria* sp. According to Butterworth (2009), seaweed is a natural feed for abalone. Abalone requires seaweed that is large enough to feed. Therefore, the use of seaweed as biofouling to feed abalone can save the need of feed for cultivation of abalone.

Tabel 1. Absbsolute growth, specific growth rate and survival rate of abalone

Parameter	Result
Absolute growth of length (cm)	0,305
Absolute growth of weight (g)	1,594
Spesific growth rate of length (%)	0,291
Spesific growth rate of weight (%)	0,495
Survival rate (%)	90,266

The data of spesific growth rate of weight was 0.291%. The value is high when compared with research Atika *et al.* (2014) who observed the growth and survival of abalone (*Haliotis Squamata*) using fiber tub as aquaculture facilities. This indicates that the abalone was able to grow well in cage by utilizing biofouling (seaweed) for the growth.

The result of survival rate in the study showed 90.266%. The value shows high survival rate than research of Hamzah *et al.* (2012) who conducted the research abalone using

concrete tanks. Results of research Hamzah *et al.* (2012) shows the abalone were stocked in concrete tanks have survival value from 81.32 to 88.89%. Results of research Minh *et al.* (2010) who cultivate on the concrete tank also showed low values (46.2 to 82%). Likewise, research Atika *et al.* (2010) who did cultivation in concrete tanks showed lower value of survival rate (78.05 to 87.6%). It showed that the maintenance of abalone in cage by utilizing biofouling (seaweed) resulted in higher survival when compared to maintenance using concrete tanks. However, research Setyono (2003) cit. Hamzah *et al.* (2012) who studied tropical abalone (*Haliotis asinina*) in cage Coast North Lombok showed 93-95%. The value of survival rate of abalone on the result of the study compared to the results of research Setyono (2003) has a lower value, but the value of the survival of 90.266% is still a great survival value for abalone.

4. Conclusion

The result showed that species of seaweed as biofouling are *Padina australis*, *Gracilaria sp.*, *Euचेuma spinosum*, *Hypnea cervicornis*, *Sargassum sp.*, *Euचेuma edule*, dan *Rhodimenia palmate*. Abalone could use biofouling (seaweed) to support the growth rate (0,291%) and survival rate (90,266%).

References

- [1] Atika, Rusliadi, and Mulyadi. 2014. Growth and Survival Rate of Abalone (*Haliotis squamata*) on Different Stocking Density. Fisheries and Marine science Faculty. Riau University.
- [2] Bloecher, N., Y. Olsen, and J. Guenther. 2013. Variability of biofouling communities on fish cage nets: a one year field study at a Norwegian Salmon Farm. *Aquaculture*, 416: 302-309.
- [3] Butterworth, A. 2009. Integrated multi-trophic aquaculture systems incorporating abalone and seaweeds. Nuffield Scholar. Australia. 39p.
- [4] Effendi, I. 1997. Biologi Perikanan. Yayasan Pustaka Nusatama. Yogyakarta. 163p.
- [5] Forster, J. 2013. A review of opportunities, technical constraints and future needs of offshore mariculture – temperate waters. Forster Consulting Inc. Washington. 23p.
- [6] Hamzah, M.S., S.A.P. Dwiono, dan S. Hafid. 2012. Pertumbuhan dan kelangsungan hidup anak siput abalon tropis (*Haliotis asinina*) dalam bak beton pada kepadatan berbeda. *J. Ilmu dan Teknologi Kelautan Tropis*, 4(2): 191-197.
- [7] Hartl, M.G.J., D. Watson, and J. Davenport. 2006. Biofouling in the marine aquaculture industry, with particular reference to finfish - current status and future challenges. University College Cork. Irlandia. 56p.
- [8] Jackson, L. 2008. Marine biofouling an invasive species: guidelines for prevention and management. The Global Invasive Species Programme and The UNEP Regional Seas Programme. 68p.
- [9] Kirkendale, L., D.V. Roberston-Andersson, and P.C. Winberg. 2010. Review on the use and production of algae and manufactured diets as feed for sea-based abalone aquaculture in Victoria. University of Wollongong. Wollongong. 200p.
- [10] Minh, N. D., S. Petpiroon., P. Jarayabhand. 2010. Growth and Survival of Abalone, *Haliotis asinina* Linnaeus 1758, Reared in Suspended Plastic Cages. *Kasetsart J (Nat. Sci.)* 44: 621-630.
- [11] Pudota, J. 2011. Seasonal variations in biofouling and plankton community connected to a large scale salmon farm. Department Biologi. Norwegian University of Science and Technology. 57p.
- [12] Sholihan, M. 2013. Pengaruh pengkayaan probiotik dan protein pakan buatan dalam budidaya abalon (*Haliotis sp.*) dihibrid. Skripsi. Program Studi Budidaya Perairan. Universitas Mataram. Mataram. 91p.
- [13] Swain, G. and N. Shinjo. 2014. Comparing biofouling control treatments for use on aquaculture nets. *Int. J. Molecular Science.*, 15: 22142-22154.
- [14] Weatherley, A.H. 1970. Fish and invertebrate culture: water management in closed system. Wiley Interscience. New York. 145p.

Growth Performance of *Kappaphycus alvarezii* with Addition of *Sargassum* sp. Extract Using Spraying Technique

Tino Feri Ananta¹, Nunik Cokrowati^{1*}, Mursal Ghazali²

¹*Aquaculture Study Program University of Mataram*

²*Biology Study Program, Faculty of Mathematics and Natural Science University of Mataram
Jln. Pendidikan No.37, Mataram, NTB*

*Email : n_cokrowati@icloud.com

Abstract

This research purpose was to study the effect *Sargassum crassifolium*, *S. cristaeifolium*, and *S. polycystum* *S. aquifolium* extract for the growth of seaweed (*Kappaphycus alvarezii*). This research was conducted on May 15th until June 19th 2016 in Ekas bay, Ekas Buana Village, Jerowaru sub-district, East Lombok, West Nusa Tenggara. Research design used Completely Randomized Design (CRD) and the data analyzed uses Analysis of Variance (ANOVA). The treatments were species of *Sargassum* and extract dose. Research parameter were absolute growth, spesific growth and carageenan. The result showed that interaction between species and dose did not have significant effect of absolute growth and spesific growth. *Sargassum aquifolium* extract with 5% dose give better absolute growth, spesific growth and carageenan content. The conclusion showed that there was no interaction between factors species and dose on the growth of *Kappaphycus alvarezii* and *Sargassum* extract could give influence on the content of carageenan.

Keywords: *Species, dose, absolute growth, spesific growth, carageenan.*

1. Introduction

Seaweed in Indonesia exploited for vegetables, fresh vegetables, pickles, cakes, puddings and sweets. One of the edible seaweed is *Sargassum* sp. which is a type of brown algae (Phaeophyta), the largest in the tropical sea. In Indonesia there are 15 of them *Sargassum* is *S. crassifolium*, *S. cristaeifolium*, *S. polycystum* and *S. aquifolium*. *Sargassum* is always regarded as a nuisance by fishermen fishing. Based on research conducted by researchers from the Marine and Fisheries Research Agency, *Sargassum* containing alginate in the stalks. When the alginate was extracted, will be very much beneficial for industrial use in food and non-food. Alginate capsules are used as materials, manufacture creams, lotions, sauces, paper, ceramics, photography and much more. Extract alginate from *Sargassum* can be color adhesive fabric in the textile industry, and the majority of alginate circulating in the country they are imported.

(1) stating that the *Sargassum crassifolium*, *S.cristaeifolium*, *S. Aquifolium* than as a source of alginates and vegetables, also contain compounds with the same molecular weight with Zeatin. Zeatin is a natural cytokines, cytokines are a group of plant hormones with an important role in the growth and development of plants such as cell division, growth and proliferation of new shoots, and the aging plant chloroplast biogenesis. Therefore, application of seaweed extract containing cytokines can increase cell division, shoot growth and proliferation of new shoots. (2) stating that this seaweed has the abundance and distribution are very high, there are almost all regions in Indonesia sea. In general, seaweed *Sargassum* sp. not widely known and used. Whereas some studies, it has been reported that the nutritional content / high enough nutrients, such as protein and some essential minerals, only the analysis

of the nutritional composition is still incomplete.

Sargassum seaweed extract to improve plant growth and development has been applied both in higher plants, algae and the tissue culture system. In higher plants has been employed to soybeans (3), that in order to increase the availability of nutrients nitrogen and increase the production of soybeans. *S. polycystum* extract with a concentration of 20% (G2) is likely to provide the number of nodules, nodule weight, shoot dry weight, N uptake and grain weight filled. For tests on algae, (4) use the *S. aquifolium* to support the growth of grass *Euchema cottoni*. With the immersion method found the best concentration of 5% with its soaking time of 60 minutes. For the application in tissue culture, (5), states alginasi technique has been widely used for the encapsulation of a wide variety of microorganisms, including fungi function as biocontrol. Biopesticides, such as *Bacillus thuringiensis israelensis* (Bti) and *Trichoderma harzianum* has been encapsulated in the form of microcapsules with sheathing materials of alginate or polyethylene. Alginasi considered an effective method, because the gel forming reaction is relatively safe at a certain temperature and is particularly suitable for cells or organisms that are sensitive to temperature. Trapping ability (encapsulation) biomass *B. bassiana* by sodium alginate and corn starch are equally effective. It shows that both encapsulation formula can be selected to produce propagules active mikoinsektisida of *B. bassiana*.

The use of immersion method in fertilizing the seaweed or sea algae have been done, but this method has a drawback for applications in scale cultivation. Applications on a scale cultivation of a high cost because it will need a container that very much. In addition to requiring a container very much, this method also takes in the process with its soaking time 1-6 hours, it will take a lot of time.

Through spraying application method is easy to apply in the scale of cultivation and also saves the use of cost, because it does not require many containers as well as the immersion method, since the method is only using a spray container that can be refilled several times. In terms of time also does not require such a long time in the immersion method, spraying only lasted for 30-60 minutes for large volumes.

In this study tested the extract 4 *Sargassum* is *S. cristaefolium*, *S. crassifolium*, *S. polycystum* and *S. aquifolium* at various concentrations on the growth of seaweed *Kappaphycus alvarezii*.

The purpose of the study was to be carried out are To determine the effect of *Sargassum* algae extract *S. crassifolium*, *S. cristaefolium*, *S. polycystum* dan *S. aquifolium* against growth *Kappaphycus alvarezii*. To determine the effect of doses of 0%, 5%, 15%, and 25% to the growth *Kappaphycus alvarezii*. To determine whether there is interaction between the factor in the type and dose of the growth factor *Kappaphycus alvarezii*. To determine the effect of the extracts from *Sargassum* algae extract *S. crassifolium*, *S. cristaefolium*, *S. polycystum* dan *S. aquifolium* against growth *Kappaphycus alvarezii*.

2. Materials and Methods

This research was conducted on May 15 until June 19, 2016, held at bay Ekas, Village Ekas Buana, Jerowaru sub-district, East Lombok. The tools used in this research is the longline, spray volume 2 Liter, Dimples, Scales, DO meter, refractometer, pH Meter, Secchidisk, Flow Meters, Camera, Stove, Glassware Measure, Tray, Oven and Pan. Materials used in research is *Kappaphycus alvarezii*, *S. crassifolium* Extract, *S. cristaefolium* Extract, *S. polycystum* Extract, *S. aquifolium* extract, NaOH, Alcohol, Seawater and Freshwater.

Data collection method used in this study is the experimental method. The experimental method is the method in which these methods take biota samples was observed. Research design used was Completely Randomized Design (CRD) with two types of 2 factors are the type and dose. Total combined treatment of 16 experimental units were repeated 3

times:

Factor 1 (Type Extract)

P1 = *S. crassifolium* Extract,

P2 = *S. cristaefolium* Extract,

P3 = *S. polycystus* Extract,

P4 = *S. aquifolium* Extract.

Factor 2 (Dose)

D0 = 0%,

D1 = 5%

D2 15%

D3 = = 25%.

Preparation of macro alga extract were:

1. Grind *Sargassum* until smooth
2. Sea water mixed with a ratio of 1: 1 mass / volume *Sargassum* 1.5 kg and 1.5 liters of sea water;
3. Squeezed extract using a soft cloth to separate the extract with the waste water;
4. Results extract 1.5 liters per *Sargassum*;
5. Do extracts dosing volume of 0%, 5%, 15%, and 25% of 2 liters of sea water;
6. Seaweed extract sprayed on *Kappaphycus alvarezii* until evenly;
7. Allowed to stand for 30 minutes, to allow time for the seaweed *Kappaphycus alvarezii* absorb extraction;

Sampling was performed six times, respectively at the age of 7, 14, 21, 28, 35, and 42 days after planting. Samples were taken at three sampling points on each rope ris in longline at each time taking samples. Because it, given that there are 48 rope ris, then taken 144 samples at each sampling time. Each sample was collected immediately weighed wet weight. Thus, the weight of the wet sample is the average value of three sample replay value. The parameters used to test the results of this research is by weighing or weight of each treatment were tested with 1 time per week sampling within 1 ½ months until harvest.

Determination of seaweed growth rate measured on a weekly basis (sampling) of observation (\pm 42 days) using the formula according to the (6):

$$G = \left[\left[\frac{W_n}{W_o} \right]^{(1/n)} - 1 \right] \times 100\%$$

Information :

G = Growth Rate (% g / day)

W_n = Weight average End (gr)

W_o = Weight average Initial (g)

n = Testing Time (days)

Absolute growth was measured using the formula of absolute growth, namely:

$$G = W_t - W_0$$

Information :

G = the average absolute growth (g);

W_t = weight of the seeds at the end of the study (g);

W₀ = weight of the seeds at the beginning of the study (gr).

Seaweed seedlings to the weight of the initial planting of 100 grams, taken a few as samples for dry weight and wet weight. In an effort to get the value of the initial dry weight of the seaweed is dried and weighed, while the final dry weight of samples performed after the harvest.

Dry weight calculation results obtained with the following formula: total dry weight (g) = (dry weight of sample (g)) / (wet weight of sample (g)) x total wet weight (g)

Preparation for getting carrageenan were done by 10 gram dry seaweed soaked in water for 24 hours and then drained and put into jars, plus solvent (pH 8) as much as 60 times its weight of 180 ml and then blend until smooth after it was cooked using a gas stove until it

thickens and then inserted into the tray and watered using alcohol, the last inserted into the oven with a temperature of 60 ° C to dry for 24 hours the longest time.

Measurement parameters of water quality were physics and chemical and done twice a week for 6 weeks of observation *Kappaphycus alvarezii* seaweed growth. Measurements in physics, including: temperature, flow velocity, depth and brightness do dilokasi *Kappaphycus alvarezii* seaweed cultivation. Chemical parameter measurements, including salinity, dissolved oxygen (DO), and the degree of acidity (pH).

The data collected during the study were analyzed using ANOVA (Analysis of Variance) and conducted a further test LSD (Least Significant Difference) if there is a significant effect (significantly different) from each treatment.

3. Results and Discussion

Results of Analysis of Variance (ANOVA) The effect of extracts of *Sargassum* sp. on the growth of seaweed *Kappaphycus alvarezii* factors and dose *Sargassum* extract can be seen in Table 1.

Table 1. Results of Analysis of Variance (ANOVA) The effect of extracts of *Sargassum* sp. on the growth of seaweed *Kappaphycus alvarezii* factors and dose *Sargassum* extract

Observation	ANOVA Test Results		
	Type	Dose	Type x Dose
Weeks 1st	S	S	NS
Weeks 2nd	S	NS	NS
Weeks 3rd	NS	NS	NS
Weeks 4th	NS	NS	NS
Weeks 5th	NS	NS	NS
Weeks 5th	NS	NS	NS
Absolute growth	NS	NS	NS
Daily Relative growth	NS	NS	NS

Description: S = Significant; NS = Non Significant

Based on the results of Analysis of Variance (ANOVA) note that spraying extracts of *Sargassum* to factor in the type and dose and interaction of these two factors do not have a significant effect ($p > 0.05$) on Sunday 3rd, 4th, 5th, ke- 6, absolute growth and daily LPR. While in week 1 on the type and dose obtained significant results, and at week 2, which has a significant influence only factor types. The first factor is *Sargassum* algae extracts 4 and the second factor is the dose extract did not have a significant influence on the results, as well as the relationship between these two factors here is no interaction between treatment *Sargassum* with a given dose of the extract.

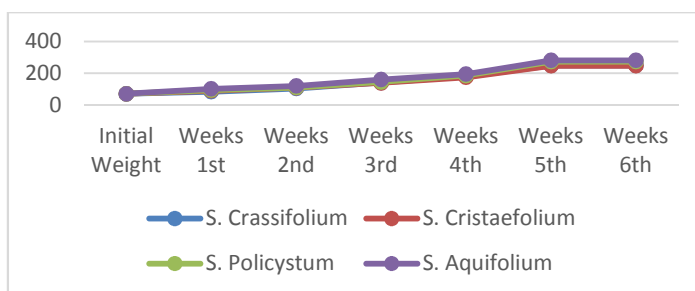

Figure 1. Growth of Seaweed For 6 Weeks with Factor Type and Dose Factor

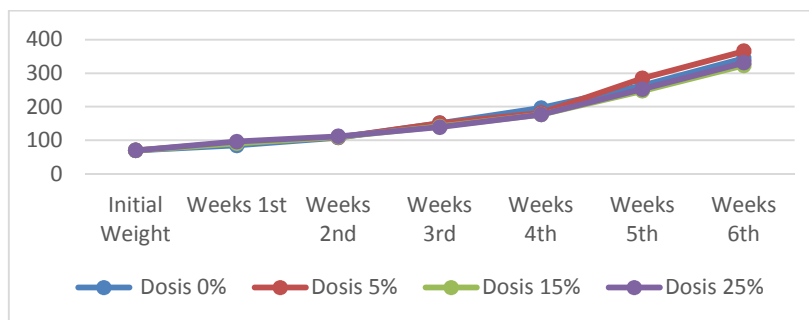

Figure 2. Growth of Seaweed For 6 Weeks with Dose Factor

The observation of weekly growth of seaweed *Kappaphycus alvarezii* by treatment with 4 *Sargassum* and 4 doses of the extract obtained at weeks 1 factor in the type and dose factors have a significant influence, but there is no interaction between the two factors. In the second week only factors that influence the type of significant and insignificant factors dose and interaction between the two factors, as well as the fourth to sixth week did not have a significant influence, Viewed from every week an increase in the growth of the weight of the seaweed, it is possible caused by the quality of the water in the farming area which is suitable for growing seaweed *Kappaphycus alvarezii* and also extract treatment appropriate to support the growth of seaweed in terms of both factor in the type and dosage indicated by *S. aquifolium* extract treatment with the best results on a weekly basis, especially in the last 3 weeks. However, on Sunday the 5th and 6th experienced steady growth or the same weight as the collapse of the thallus caused by ris rope wrapped around and also how to retrieval of samples as well as current research sites. (7) states that the weight of wet seaweed when observations showed improvement from week 1 to week 6, it is suspected due to factors aquatic environment parameter study site that supports both physics and chemistry as well as biology. Factors supporting the water parameters of which there are sufficient nutrients and also the speed of flow is relatively normal for the growth of seaweeds *Eucheuma cotonii* wherein the mixing process so that the absorption of nutrients by the seaweed indicated either that causes the growth of seaweeds *Eucheuma cotonii* tends to increase. In addition to other factors such as the sun, temperature, salinity, pH, wave, and dissolved oxygen also impact the growth and development of seaweed *Eucheuma cotonii*.

Data from the study showed that the extract of *Sargassum* effect although not significantly different from the results of the control (no treatment). This is according to a statement from (1), that *Sargassum* sp. contain Plant Growth Regulator (PGR) in the form of auxin, cytokinin and giberlin. Auxin act as relaxants cell walls and cell wall enzyme-destruct. While useful as extenders giberlin cells and cytokines serve as a spur in cell division. According (8) auxin cause recipient cells on the stem cells secrete H + wall primer that surrounds that will lower the pH. This leads to the relaxation of the wall and into rapid growth. Low pH is believed to activate some destructive enzymes wall so as to allow easier walls tenuous. George and (8) adds that auxin will cause the pectin soluble and stem cell wall becomes soft and can increase the absorption of water and selakan expands. This is also supported by the presence of gibberellins and cytokinins. (8) giberelin role in internodus stem elongation by stimulating cell elongation. While cytokines play a role in encouraging cell division (8).

Better treatment that *S. aquifolium* treatment with a dose of 5% and the lowest

adalah 5% with extracts of *S. cristaefolium*, from these results correspond with previous studies conducted by (4) with the best dose of 5% using the technique of soaking 60 minutes. Dosing with 5% *S. aquifolium* extract gives the best results because the more nutrients more is not good for plants and is influenced by the surrounding environment, it is influenced by the nature of the food plants that absorb passively and actively. (9) suggest seaweed grows with the absorption of active and passive absorption. The absorption of active seaweed for transpiration directly and influenced by the environment. While passive absorption is absorption that occurs because of the rapid transpiration which is a response back by seaweed on the environment, light, salinity, temperature and dissolved oxygen.

From the results of the weight of carrageenan obtained the best treatment is the treatment with *Sargassum aquifolium* dose of 5% and the lowest treatment with *Sargassum polycystum* by 15%. While the percentage of carrageenan obtained results with the formula weight divided by the sample weight carrageenan dried and then multiplied by one hundred percent.

Table 2. weight and percentage of carrageenan from seaweed *Kappaphycus alvarezii* with the addition of four kinds of extracts of *Sargassum* and 4 doses of the extract.

Treatment	Carrageenan Weight (gram)	Percentage Carrageenan (%)
PD0	3.0 ±0.00	30±0.00
P1D1	3.8±0.00	38±0.00
P1D2	2.3±0.00	23±0.00
P1D3	2.0 ±0.00	20±0.00
P2D1	1.5±0.00	15±0.00
P2D2	2.1±0.00	21±0.00
P2D3	1.2±0.00	12±0.00
P3D1	2.5±0.00	25±0.00
P3D2	1.1±0.00	11±0.00
P3D3	2.5±0.00	25±0.00
P4D1	4.2±0.00	42±0.00
P4D2	2.6±0.00	26±0.00
P4D3	2.4±0.00	24±0.00

Carrageenan test results proved that the best treatment is treatment of *S.aquifolium* a dose of 5% and the lowest was treated with doses of 5% *S. polycystum*. (10) stated that the quality of carrageenan is closely related to factors at the time of cultivation, harvesting and post-harvest handling and methods extraction. One the factors leading to the low quality of carrageenan is a seaweed harvesting different. (10) stated that the harvesting is done when the seaweed has been certain weighed. Harvest can be performed after 6 weeks, which is when the plants are considered mature enough to contain the maximum polysaccharides (10) . Harvesting 50 days give the highest gel strength and significantly different with harvest age 40, 45, and 55 days. The older age of the harvest, the strength of the resulting gel tends to increase, and will decrease after reaching the peak of growth (10)

In the carrageenan test results also include carrageenan colors brown and murky, it is related to color quality carrageenan. According (10), Color brownish carrageenan reviews their still could be due to cellulose, pigments fikoeritin, and fikosianin. Aside from being components larutair, cellulose also causes color carrageenan become cloudy. (10), namely , Added harvesting is likely to cause the degree of experience a decline. White matter carrageenan is expected, with increasing age harvest will increase the content of cellulose,

which is a component that can affect carrageenan color. The presence of cellulose in high-carrageenan in an amount not expected because it can cause the color of carrageenan into turbid.

Results of water quality during the measurement within 6 weeks of ups and downs tend to be stable at cultivation. Water quality measurements such as temperature on farms ranging between 29-32 ° C. Optimal water temperature around the plant seaweed (*Eucheuma cottonii*) range between 26-30 ° C (11) The temperature can affect the photosynthesis of sea either directly or indirectly. Direct effect as temperature plays a role in the enzymatic reaction reaction to controll the process of photosynthesis.

Salinity range of research sites in the bay Ekas is 29-34 ppm. According (12) the range of salinity good for seaweed *Eucheuma cottonii* is 28-35 ppt. Then the location used as a point of seaweed cultivation in accordance with salinity required by seaweed (*Eucheuma cottonii*). Extreme changes in salinity can cause disease ice- ice.

The degree of acidity (pH) for 6 weeks at the study site ranged between 9.6 to 10.3. Bodies base (7-9) is waters productive and contribute to encourage the process of changing organic matter in water into minerals that can be in assimilation by phytoplankton waters of the sea and the coast has a pH relatively stable and is within a narrow range, typically ranging between 7 , from 7 to 8.4. influenced by the pH buffering capacity (buffer) that is the salts of carbonate and bicarbonate that it contains (9).

The brightness value at the study site during the six weeks which is about 3.5 to 4.1 m, while research into the location which is approximately 7 m. Waters ideal brightness is more than 1 m. Turbid water (usually containing sludge) can block the break of sunlight in the water so that the process of photosynthesis is interrupted, while Depth is good for growth seaweed is 0.3 to 0.6 m (12)

Dissolved oxygen (DO) contained in the study site has a range of between 5.84 to 7.29 mg / L. Dissolved oxygen is a limiting factor for all living organisms. Dissolved oxygen is a basic requirement for the survival of living beings in the water. Dissolved oxygen to support usahabudidaya seaweed is 3 - 8 mg / l (12).

Flows on farms for 6 weeks ranging from 20-40 m / m. Current velocity is good for the growth of seaweed ranges. between 0.2 to 0.4 m / s. Flow devastating for seaweed in nutrient capture and bring food sources (11).

4. Conclusions

Factor type *S. crassifolium*, *S. cristaefolium*, *S. polycystum* and *S. aquifolium* a significant influence on the first week of the second and not leave significant effect on the third week, fourth, fifth, sixth, and LPR daily absolute growth to the growth of seaweed (*Kappaphycus alvarezii*), Factors dose to 0%, 5%, 15%, and 25% have a significant influence on the first week alone, while in the next week and also on the absolute growth as well as daily LPR does not provide a significant influence on the growth of seaweed (*Kappaphycus alvarezii*). There is no interaction between factors dose and type of factors on the growth of seaweed (*Kappaphycus alvarezii*) on a weekly basis and the results of observations of absolute growth and daily LPR. Extract *S. crassifolium*, *S. cristaefolium*, *S. polycystum* and *S. aquifolium* influence on the content of carrageenan, evidenced by the best treatment that *S. aquifolium* dose of 5%.

References

- [1] Nikmatullah, Aluh., Gazali, Mursal., Kurnianingsih, Rina., Mulyawarni, Dan Sunarpi .. 2014. Ability Aquadest Some Macro Algae Extract Lombok Island, Indonesia In Stimulates Growth of Rice. *Agrotechsoc Volume 24*
- [2] Handayani, Tri., Sutarno., Setyawan, Ahmad, Dwi. 2004.. Analysis of the Nutritional Composition of Seaweed *Sargassum crassifolium* J. Agardh. *Biopharmaceutical 2 (2): 45-52*
- [3] Indriyati, Ryrien., Lubis, Alida, and Jamilah .. 2015. Giving Brown Algae Extracts (*Sargassum*

- polycystum) and Bradyrhizobium japonicum to Improve Nutrient Nitrogen and Soybean Crop Production. *Online Journal Agroecotechnology* No. 2337- 6597Vol.3, 2
- [4] Ali, Akbar, Bambang.. 2015. The Effect of Extract *Sargassum aquifolium* on Growth *Kappaphycus alvarezii*. *Essay*. University of Mataram. Mataram.
- [5] Putra, Bayu, Dwinata., Baryawati, Riris., dan Isnaini.. 2011. The Rate of Growth seaweed Gracilaria sp. with Different Planting Methods in Caliandra Waters, South Lampung. *Maspari Journal* 03 (2011) 36-41
- [6] Wahyudi, Priyo.. 2008. Encapsulation Propagule entomopathogenic fungus *Beauveria bassiana* Using Alginate and Starch Products corn as Mikoinsektisida. *Jurnal Indonesian Pharmaceutical Sciences* Page. 51-56 Vol. 6, No. 2
- [7] Wijayanto, Tri., Hendri, Muhammad., Aryawati, Riris .. 2011. Growth Study Seaweed *Eucheuma cottonii* with Various Planting Methods different Bodies Trump, South Lampung. *Maspari Journal* 03 (2011) 51-57
- [8] Kusumaningrum, Indri., Budi, Hastuti., Rini dan Haryanti Sri. 2007. Influence *Sargassum crassifolium* juice with Different Concentrations Hampered the Growth of Soybean Plants (*Glycine max* (L) Merrill). *Bulletin Anatomy and Physiology* Vol. XV, No. 2, October 2007
- [9] Susilowati, Titik., Rejeki, Sri., Nurcahya, Dewi, Eko., dan Zulfitriani.. 2012. Depth Influence On The Growth Of Seaweed Cultivated By The Method Of Longline On The Beach Mlonggo, Jepara Doistrict. *Journal Saintek Fishery* Vol. 8. No. 1, 2012
- [10] Robinson, Wenno, Max., Louretha, Thenu, Johanna., dan Gracia, Cristina, Lopulala, Cynthia.. 2012. Kappa Carrageenan Quick Communication Characteristics of *Kappaphycus alvarezii* on a variety of different ages. *JPB Fishery* Vol. 7 No. 1 Tahun 2012: 61 –67.
- [11] Anggadiredja, J. T., Zalnika, Ahmad., Purwanto, Heri., Istini S. 2008. Seaweed. Penebar Swadaya. Jakarta.
- [12] Directorate General of Aquaculture. Technical 2008. User Cultivation Seaweed *Eucheuma* spp. DKP RI, Ditjenkanbud. Jakarta.

Development of e-SCM Open Source as Integration of Data Management For Fish Farmers SMEs in Pasar Ulekan Bandung

Yudi Priyadi¹, Jurry Hatammimi^{2*}

^{1,2}*Departement of Telecommunication and Informatics Business Management,
School of Economics and Business, Telkom University.*

** jurryhatammimi@telkomuniversity.ac.id*

Abstract

In general, e-SCM-based Open Source is a framework that conduct collaborative use of information technology for the flow of information, materials, finance, services from producers to consumers to achieve the efficiency of activities and costs on all entities involved in the system. Business potential is still very large ornamental fish to thrive. It can be observed from the data of Agricultural Census 2013-2014, that the income from this business ranks first on fishing effort. Small and Medium Enterprises (hereinafter referred to as SMEs) is a transformative companies that are committed to continue the development and growth. These relationships involve the key stakeholders such as customers, employees, suppliers, and competitors. The use of modeling notation DFD is part of a context diagram, which is one modeling notation in information systems. DFD contained in the draft Notation Data Store that will be implemented into a table in the database. In information systems modeling, a Data Store in a DFD will be modeled by E-R diagram be Notation Entity. To design a business process reengineering in this activity, generate context diagram called “E-SCM UKM Ikan”, which consists of five entities involved directly with the system, namely: supervisor fish shop, fish shop retailers, employees, fish farmers, and customers. Referring to the Context Diagram, there is decomposition process “E-SCM UKM Ikan” Level 0. Decomposition produces Data Flow Diagram Level 1 consists of four sub processes, namely: business partner, transaction, the stock of retailers, and documentation. For the integration of data management, there is a Localhost Server e-SCM, using <http://whyphi:8080>, as the address for the prototype.

Keywords: *e-SCM, Open Source, Data Management, Context Diagram, DFD, E-R Diagram.*

1. Introduction

Through the description of the Government Work Plan (GWP) Sector Empowerment of Cooperatives and SMEs in 2014, that there are 42 million data regarding the perpetrators of Small and Medium Enterprises (hereinafter referred to as SMEs), which are scattered in 23 government agencies. Referring to the Law of the Republic of Indonesia Number 20 of 2008, concerning micro, small and medium business development activities. In Article 17 through Article 20, there is a description of the business development for the increase in production, processing, marketing, human resources, design, and technology. An activity that can be collaborated to handle the business processes of SMEs mentioned above is Open Source technology and the Electronic Supply Chain Management (hereinafter referred to as e-SCM). Business potential is still very large ornamental fish to thrive. It can be

observed from the data of Agricultural Census 2013-2014, that the income from this business ranks first on fishing effort. In the tabulation of data Spatial Plan in Bandung from 2011 to 2013, Pasar Ulekan including the location being the center of the development of Sub City Services and the Center for the Environment by indications of commercial activity program trading and Sub-scale entertainment City Territory, Even this stagnant market to increase revenues, due to difficulties in adopting the technology supply chain.

2. Methods and Design

2.1. The combination of Fishbone Diagrams and Charts Research

There are four categories for the stagnation of SME business processes fish farmers, namely Man Power, Machine, Methods, and Materials. Of these categories, some problems can be grouped its implementation in the first year and second year. For the four categories that performed in the first year (Phase 1), the cause is as follows:

1. Not understanding the Electronic Data Interchange for production transaction (Tidak memahami Electronic Data Interchange untuk transaksi produksi)
2. Not to understand the accounting of financial data (Belum memahami pembukuan data keuangan)
3. Not understanding the Supply Chain (Tidak memahami Supply Chain)
4. Data on the supply of fish is not available (Data pasokan ikan tidak tersedia)
5. Hardware/Software for business process improvement is not owned by SMEs (Hardware/Software untuk peningkatan proses bisnis tidak dimiliki oleh UKM)
6. Promotion inconsistent (Promosi tidak konsisten)
7. Fish stocks are not monitored (Stok ikan tidak dimonitor)
8. Distribution of goods do not flow (Distribusi barang tidak mengalir)
9. Do not perform data management (Tidak melakukan manajemen data)
10. The concept of supply chain is not used (Konsep supply chain tidak digunakan)
11. Material for the standard prices do not (Material untuk standar harga tidak dilakukan)
12. Less cultivation of fish seeds (Kurang budi daya bibit ikan)
13. Raw material of fish feed is not available (Bahan baku pembuatan pakan ikan tidak tersedia)
14. Delay of fish stocks and feeding areas (Keterlambatan stok ikan dan pakannya)
15. Not available data/information supply of fish (Tidak tersedia data/informasi pasokan ikan)

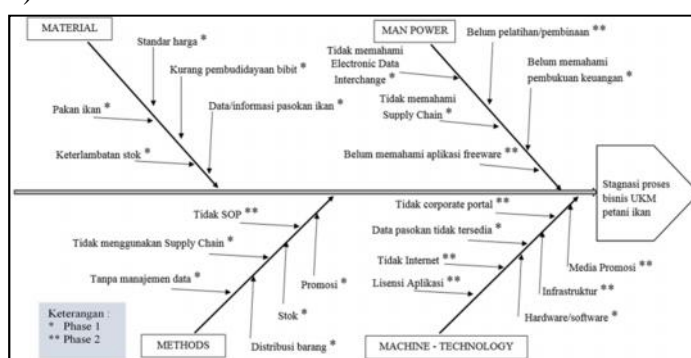

Figure 1. Adoption Fishbone for Research

2.2 Stages of Application Development

Referring to the specific purpose of the research, the following is an explanation of the stages of development of Open Source e-SCM adopted the framework as waterfall development cycle. Steps being taken for this study in the first year, includes grooves that can be observed in Figure 2.

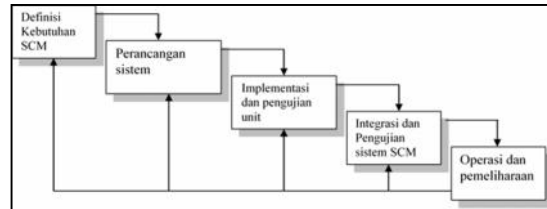

Figure 2 Adoption Stages Waterfall for Research [14]

After each step is defined, the steps in signing off and continued development in the next step. This model has been obtained from other engineering process, which offers a way of making software more tangible. Description of the stages are as follows [14]:

1. Analysis and Requirements Definition (Analisis dan Definisi Kebutuhan)
2. Software and system design (Perancangan sistem dan Perangkat Lunak)
3. Implementation and testing unit (Implementasi dan pengujian unit)
4. Integration and Testing System (Integrasi dan Pengujian Sistem)
5. Operations and Maintenance (Operasi dan Pemeliharaan)

3. Discussion

3.1. Context Diagram of Existing System

Referring to Figure 3, it can be observed that the existing system is composed of four entities that are directly involved, namely: petani ikan (fish farmers), toko ikan (fish shop), kurir (courier) and pembeli (buyers).

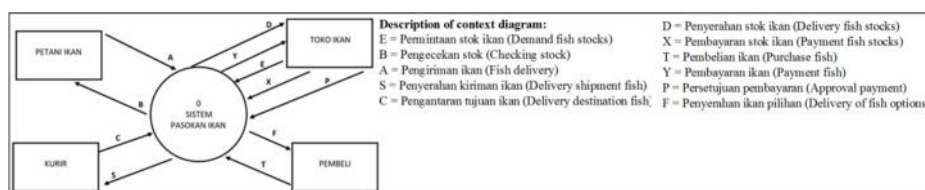

Figure 3. CD of Existing Systems

3.2. DFD and Data Store of Existing Systems

DFD are used to determine the details of the process, which is contained in a Context Diagram. Therefore, the details of the process can be observed in Figure 6 which presents the results of a data flow diagram breakdown at level 1. In the diagram, we can know the details of the process that consists of three sub-processes, namely: transaksi stok (stock transaction), transaksi kurir (courier transaction), and transaksi konsumen (consumer transactions). In addition, there is also the use of one data store, the name is simpan (save).

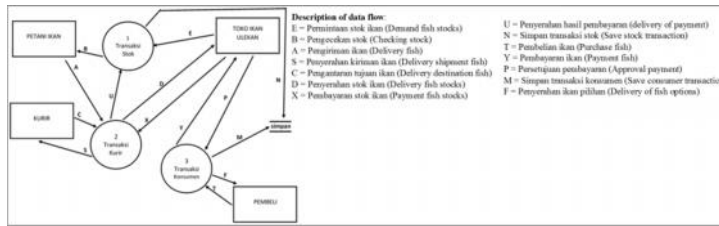

Figure 4. DFD of Existing Systems

Referring to Figure 6 of the DFD of the existing system, it can be observed that the existence of data storage on the system is not very support business processes for fish supply system. In the picture, the role of notation data store only as a medium for recording transactions of buying and selling of fish, even many transactions were never documented. However, this media can be used as the basis for the development of BPR in e-SCM, so that the fundamental issue in this system, namely the SME business processes stagnation fish farmers, can find a solution. Table 1 contains the explanation of connectivity between entities, sub processes and data store occurred in context diagram Level 1.

Table 1 Relationship of Entities, Sub-Process and Data Store

ENTITY	SUB PROCESS	DATA STORE
Pembeli	TransaksiKonsumen	Simpan
TokolkanUlekan	TransaksiStok	Simpan
TokolkanUlekan	TransaksiKurir	
TokolkanUlekan	TransaksiKonsumen	Simpan
PetaniIkan	TransaksiStok	Simpan
PetaniIkan	TransaksiKurir	
Kurir	TransaksiKurir	

3.3. Business Process Reengineering for CD/DFD and E-R Diagram

The next activity is to create Business Process Reengineering (BPR) based on the existing system that has been described previously, by adopting the scheme Open Source e-SCM. Referring to Figure 7, there is a change in the flow of data and the entities involved. This happens from Context Diagram engineering with e-SCM scheme. In this figure, there are five entities involved directly with the system, namely: supervisor toko ikan (supervisor fish shop), retailer toko ikan (fish shop retailers), employees, petani ikan (fish farmers), and customers.

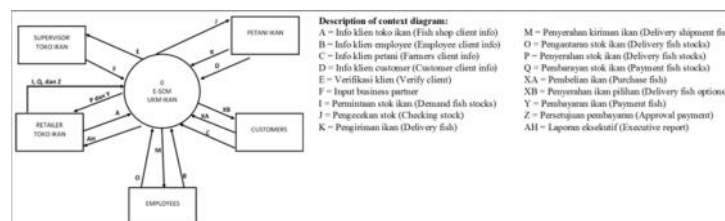

Figure 5. CD of E-SCM UKM Ikan

Based on Figure 6, there is a breakdown DFD results for level 1. In the diagram, there are four sub-processes, namely: business partner, transaksi (transaction), stoknya retailer (the stock of retailers), and dokumentasi (documentation).

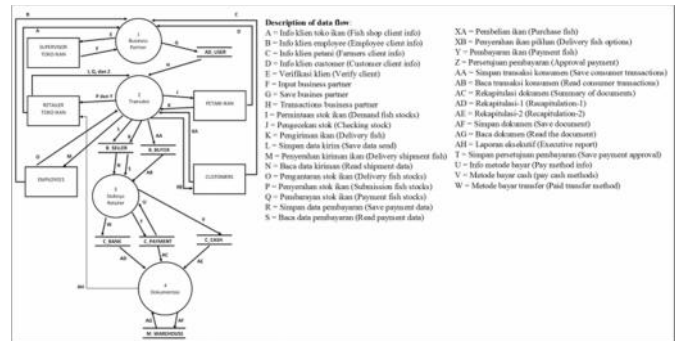

Figure 6. DFD of E-SCM UKM Ikan

Designing models for data management, data storage is engineered to the process of e-SCM. This design, built based on the existence of the data store on the DFD for all levels.

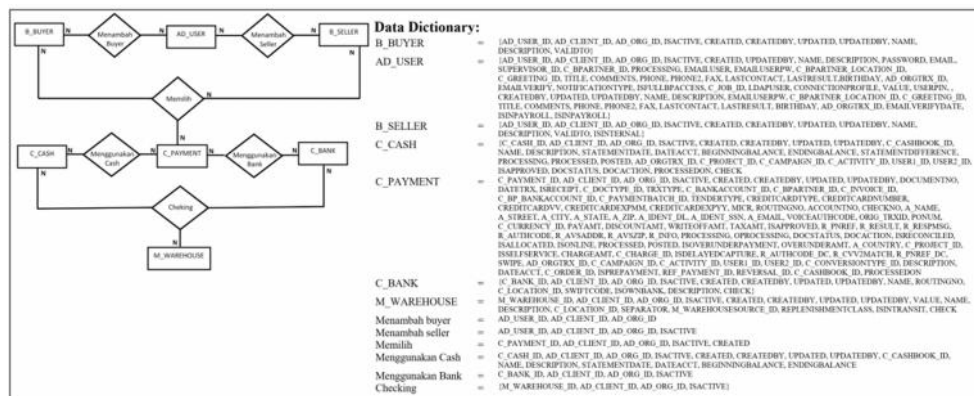

Figure 9. Data Dictionary in the E-R Diagram

When referring to the design of DFD modified, then all data store contained in the DFD will be the entity on the E-R Diagram. The entity comprised of B_BUYER, AD_USER, B_SELLER, C_CASH, C_PAYMENT, C_BANK, and M_WAREHOUSE. Use of the data dictionary at E-R Diagram, aims to show the relationships between entities without being disturbed by the presence of key attributes and descriptive attributes. This can be observed in Figure 9, which presents the use of the data dictionary to E-R Diagram.

1.4. The Result of Engineering Prototype e-SCM Applications

Here is some footage of the experimental results to the adjustment of business processes in Pasar Ulekan with open source e-SCM, as follows:

1. Address localhost. To test engineering this application, used a server that is local to the address <http://whyphi:8080>
2. The database used in this application uses PostgreSQL that is open source, so it is suitable to the application of e-SCM. Referring to the database, there are several core tables are modified according to the needs of the system.

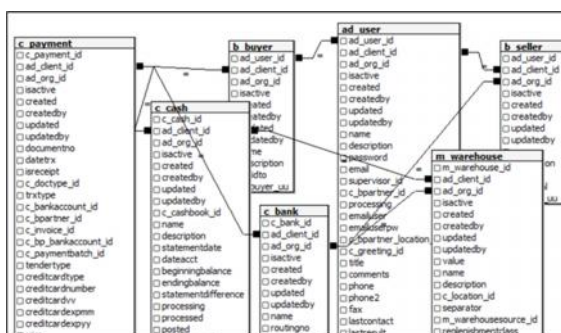

Figure 8. Relations on the Physical Table

3. Login form e-SCM, using the display input from applications that are tailored to the needs of the fish supply chain system



Figure 9. The prototype for Form Login e-SCM (iDempiere)

4. Conclusions

In general, the research develops SCM applications for SMEs fish farmers based Open Source, through the implementation of E-SCM collaboration and Data Management. Additionally, in particular the research has reached the following results:

1. In designing the model of existing system, for Context Diagram Level 0 there are four entities involved, namely: fish farmers, fish shop, courier and buyers. Referring to the Fish Supply System Diagram Context, there is decomposition process Level 0, which produces Data Flow Diagram Level 1 with three sub-processes, namely: the stock transaction, the transaction courier, and consumer transactions.
2. In the existing modeling system for data management, there is the use of one data store, named "simpan". The role of the existing data store of this system, just as the media to record the sale and purchase transactions of fish, often not even been documented for the transaction. Based on these facts, the use of the concept of ER-Diagram for the existing system cannot be used.
3. To design a business process reengineering in this activity, generate context diagram called E-SCM UKM Ikan, which consists of five entities involved directly with the system, namely: supervisor fish shop, fish shop retailers, employees, fish farmers, and customers. Referring to the Context Diagram, there is decomposition process E-SCM UKM Ikan Level 0. Decomposition produces Data Flow Diagram Level 1 consists of four sub processes, namely: business partner, transaction, the stock of retailers, and documentation. In addition, for the activities of data storage

on the Data Flow Diagram Level 1, which produced seven data store of e-SCM process, as follows: B_BUYER, AD_USER, B_SELLER, C_CASH, C_PAYMENT, C_BANK, and M_WAREHOUSE.

4. For the integration of data management, there is a Localhost Server e-SCM, using <http://whyphi:8080>, as the address for the prototype, which can be adopted by SMEs fish farmers in the research for the second year.

References

- [1] Ascef, Rogers. Ferrer, Geraldo. & Mullins, Steve. (2014). "Supply Chain Management and its Route to Normal Science: a Kuhnian Analysis", *Journal of Operations and Supply Chain Management*, Vol. 7 no. 2, pp.59 - 74
- [2] Blanchard, D. (2010). *Supply chain management best practices* (2nd ed.). Hoboken, NJ: John Wiley & Sons.
- [3] Chopra, S., and Meindl, P., 2001, *Supply chain management: Strategy, planning, and operations*. New Jersey - Prentice-Hall.
- [4] CSCMP. (2004). CSCMP Council of supply chain management professionals. Tersedia di: <http://cscmp.org/about-us/supply-chain-management-definitions> (diakses 19 Maret 2015)
- [5] Durkin, Mark., McGowan, Pauric., & McKeown, Niall. (2013), "Exploring social media adoption in small to medium-sized enterprises in Ireland", *Journal of Small Business and Enterprise Development*, Vol. 20 No. 4 pp. 716 - 734
- [6] Friedman, Andrew L., Miles, Samantha. & Adams, Cameron (2000) "Small and medium-sized enterprises and the environment: evaluation of a specific initiative aimed at all small and medium-sized enterprises", *Journal of Small Business and Enterprise Development*, Vol. 7 No. 4, pp.325 - 342
- [7] Giménez, Cristina. Lourenço, Helena R. (2008). "e-SCM: internet's impact on supply chain processes". *Emerald Insight - The International Journal of Logistics Management*, Vol. 19 Iss 3 pp. 309 - 343
- [8] Halley, Alain & Guilhon, Alice (1997) "Logistics behaviour of small enterprises: performance, strategy and definition", *International Journal of Physical Distribution & Logistics Management*, Vol. 27 No. 8, pp.475 - 495
- [9] Lummus, Rhonda R. & Vokurka, Robert J. (1999) "Defining supply chain management: a historical perspective and practical guidelines", *Industrial Management & Data Systems*, Vol. 99 Iss: 1, pp.11 - 17
- [10] McLeod, Raymond, Jr. (1995). "Management Information System. 6th ed". Prentice - Hall, NJ.
- [11] Priyadi, Yudi (2014). "Kolaborasi SQL & ERD Dalam Implementasi Database (ISBN:978-979-29-2195-3), Andi Publisher
- [12] Ross, David Frederick, 2003. "Introduction to e-supply chain management: engaging technology to build market-winning business partnerships", CRC Press LLC, 2000 N.W. Corporate Blvd., Boca Raton, Florida 33431
- [13] Rencana Kerja Pemerintah (Rkp) Bidang Pemberdayaan Koperasi Dan Ukm Tahun 2014
- [14] Turban, E., McLean, E., Wetherbe, J. (2007), "Information Technology for Management", John Willey & Sons, Inc.
- [15] Undang-Undang Republik Indonesia Nomor 20 Tahun 2008 Tentang Usaha Mikro, Kecil Dan Menengah.

Seasonal Comparison of Aquatic Macroinvertebrate Benthic were Collected in Powerplant Segment Sidutan Stream, North Lombok

Nanda Diniarti

*Aquaculture Study Program, Universitas Mataram
nanda_unram@yahoo.co.id*

ABSTRACT

Every season has different effect to organism live on stream. Current velocity and water level are the water quality factors has direct effect to macroinvertebrate benthic. This study aims to look at the types of variations that appear in every season. The research was conducted in the dry season (June 2016) and the rainy season (January 2016). Observation stations are divided into three, before inlet of power plant, Outlet and 200 m after the outlet. Macroinvertebrate benthic are collecting by kicking method. The results showed that the number of species and diversity were found different between the dry season to the rainy season.

Keywords: *comparison, dry season, macroinvertebrate benthic, rainy season, stream*

1. Introduction

Macroinvertebrate benthic has long been used as bio-indicators of water, especially in a dynamic or moving waters such as rivers. The existence of macroinvertebrate benthic depending waters condition is meant here are the parameters of physics, chemistry and biology waters [1].

Physical parameters in the river is the main parameter because it is directly related to the distribution, abundance, diversity and community composition of benthic makroavertebrata [2]. Current velocity and change of water level that affect to river depth are the physical parameters. Both physical parameters are strongly influenced by landforms and the weather / season.

The type of benthic macroinvertebrate does not always appear in each season. The type is able to adapt to the condition of the particular season has high the appearance, medium who can not adapt will limit the appearance of even choose dormant. Variations of this species must be known to find out what happens every season of the types of information that the collected. The purpose of this study is to see the types of variations that appear in each of the dry season and rainy on the river, especially in the segment Micro Hydro Powerplant in Sidutan River Santong.

2. Materials and Methods

Location of study Sidutan stream in the Santong village District of Kayangan was conducted in January (rany) and June (dry) 2016.

The tool was used are: D-net frame with a size (20 x 30 cm, mesh size 500 mm), DO meter Lutron 5510, stereo microscope, bottle collection and plastic jars. Materials was used : formalin 4% as a preservative and 70% alcohol preservative collection.

Selection sampling sites of macroinvertebrate benthic and water quality based on the location of the MHP to the river. Based on the location of the MHP determined three locations namely observation example: Before Inlet, Outlet and 200 m after the outlet. Macroinvertebrate benthic was collected using the kick-net sampling techniques, which

shuffles bottom of the river using a foot and look at the representation of the zone. Makrovertebrata benthic identified to family level, if possible to genus level with identification book [3], [4], and [5]. Water quality which was analyzed in-situ such as DO, temperature, current speed and water depth. Once sorted and identified then see the difference each season for macroinvertebrate benthic community structure to calculated Shannon and Weiner diversity index, dominance index simpsons [6] and Signal-2 / Stream Invertebrate Grade Number Average Level 2 [7].

3. Results and Discussion

The water quality in the dry season is different than during the rainy season. Water quality parameters are very different is the water depth, current speed and the concentration of dissolved oxygen (DO). In the dry season has a high flow velocity compared with the rainy season. Similarly, the DO concentration. Indonesia at 2016 had the effect of *La Nina* that despite in dry season rainfall remains high. The day before sampling in June (dry), Sidutan River basin hit by rain with a high itensity. It can be seen on the river bank eroded and into the depth of stream was rise.

Table 1. Comparison water quality at rainy and dry seasons

Water Quality	Rainy			Dry		
	S.1	S.2	S.3	S.1	S.2	S.3
Temperatur (°C)	21,5	22,7	22,7	24,2	21,7	20,7
Water depth (m)	0,4	0,3	0,5	0,5	0,4	0,7
Current velocity(m/s)	0,6	1	0,8	0,2	0,3	0,6
Dissolved Oxygen (mg/L)	5,2	8,5	9,5	9,5	11,8	12

There are some family that appears on every season but some appear only in a particular season (Table 2). The kind that appear in the second season was from Family crane fly, Gerridae, Physidae etc. This species has a high adaptability as the gastropod class. [8], declared that the gastropod has high adaptability to the environment. Gastropods have a shell to protect against adverse environmental effects. The type appears only in the dry season or rainy was representatives of the Order severally. For example in the Order Tricoptera the rainy season was represented by Leptophlebiidae being the rainy season was represented by Sericostomatidae.

Table 2. Macroinvertebrate Benthic just seew at rainy and dry season

No	Rainy	Dry
1	Corixidae	Dytiscidae
2	Philopotamiidae	Stratiomyidae
3	Aescriidae	Glossiphonidae
4	Elminthidae	Sericostomatidae
5	Leptophlebiidae	Hidrophicidae
6	Hidroptilidae	Nematocera
7	Leptoceridae	Mycetophilidae
8	Psepnisidae	Limnocaridae
9		Caenidae
10		Habrophlebia
11		Ecdyonuridae
12		Hydropsychidae
13		Psychomyiidae

From the ecological index were compared during the rainy season and the dry seen improvements in the wet dry season. Where the dirt in the stream will drift away from the site so that the index during dry season better than wet season.

Table 3. Ecological index every seasons

Ecology Index	Rainy			Dry		
	S1	S2	S3	S1	S2	S3
Families	10	8	12	11	11	12
Diversity (H)	1,70	1,57	2,01	1,99	2,38	2,36
Dominance	0,38	0,36	0,46	0,44	0,51	0,50
Signal 2	4,30	3,36	4,55	4,90	4,15	5,42

4. Conclusion

There are differences in water quality, type of macroinvertebrate benthic was appear and ecological ndex during the dry season and the rainy season. 2016 dry season has better water quality than in the rainy season.

References

- [1]. Bruce, JF. 2002. Characterization and Analysis of Temporal and Spatial Variations in Habitat and Macroinvertebrate Community Structure, Fountain Creek Basin, Colorado Springs and Vicinity, Colorado, 1998-2001. Water_resources Investigations Report 02-4093. U.S. Geological Survey. Denver.
- [2]. Brooks, RT. 2000. Annual And Seasonal Variation And The Effects Of Hydroperiod On Benthic Macroinvertebrates Of Seasonal Forest (“Vernal”) Ponds In Central Massachusetts, USA. *Wetlands*. 20:4:707-715.
- [3]. Quigley M. 1977. Invertebrates on Stream and River: A Key to Identification. London: Edward Arnold Publishers Ltd.
- [4]. Pennak RW. 1978. Freshwater Invertebrates of United States. Ed ke-2. Wiley Interscien. New York: John Wiley and Son Inc.
- [5]. Mc Caffery WP. 1981. Aquatic Entomology. The Fishermen’s and ecologists’ illustrated guide to insects and their relatives. Boston : Jones and Barlett Pub.
- [6]. Abel PD. 1989. Water Pollution Biology. London. John Wiley and Sons Ltd.
- [7]. Chessman BC. 2003. A scoring system for macroinvertebrates (water Bugs) in Australian rivers. User manual. Monitoring River Health Initiative Technical Report no 31, Commonwealth of Australia, Canberra.
- [8]. Diniarti, N. 2015. Keragaman Gastropoda yang Mendapat Masukan Limbah Tahu-Tempe di Kali Ancar. *Biowallacea*.3:140-142.

Economic Analysis of Direct Loan Cattle Dispersal System in Sumbawa District

Anggi Fitriza*, Hermansyah

Faculty of Animal Husbandry, University of Mataram, Mataram – 83115, Indonesia

**Email: anggifitriza90@gmail.com*

Abstract

This research aimed to analyze the profitability and factor affecting income of farmers in the direct loan cattle dispersal system (Bantuan Pinjaman Langsung Masyarakat, BPLM) in Sumbawa district, West Nusa Tenggara. A survey method was used in this study. 50 farmers in 9 districts who received the direct loan cattle dispersal system were selected purposively. Results of this study showed that the net income of farmers receiving the direct loan is Rp. 24,005,548/breeder/year or Rp. 2,000,462/breeder/month. The three independent variables affecting the farmer income were number of household member, farmer age and farmer education level. On the other hand, farmer experience in raising cattle did not significant effect on income of farmers receiving the direct loan system of cattle dispersal system in Sumbawa district, West Nusa Tenggara province.

Keywords : *Farmer income, beef cattle, experience farmer*

1. Introduction

The west Nusa Tenggara province in the context if national development has prioritized the one of livestock area and also to become a purification area of Bali cattle. This condition gives hope that NTB is expected to become the provider of national livestock continuously to maintain that preservation.

The one of the effort of the regional government of west Nusa Tenggara to helping overcame the economic community is with providing economic opportunity for farmers through the cattle distribution of Direct Loan Aid Society (BPLM). Aid distribution of beef cattle in BPLM in Sumbawa district carried out since 2002. The purpose of this program to strengthen the venture capital groups in agribusiness, increase production and productivity of agribusiness, group income, improve the independence, and teamwork.

Sumbawa regency has an area of 6,643.98 km² with a population of 419,989 people. About 66,37% most residents of Sumbawa livelihood as farmers. The total cattle population of Sumbawa district in 2011 were 38.505 horses, 164,505 cattles, 55,706 buffalos, and 39,396 goats (BPS). These conditions provide opportunities that farm businesses are able to be developed in this area

This study aims to identify income of the farmer that received the direct loan aid society (BPLM) in Sumbawa district and the factor that affects the income of the recipient direct loan aid society (BPLM) in Sumbawa district.

2. Materials and Methods

This study using survey method. The sampling method conducted through purposive sampling approach, with cattleman's sample basis was incorporated within breeder groups cattle business recipient community direct loans aid society (BPLM). The total of a sample used 50 respondents. As the primary data obtained by using interview with questionnaire, while as the secondary data obtained from scientific report, record or documents from

relevant departement as well as literature or references that are relevenat to research. The analysis of this research are applying the income analysis and multiple regression analysis.

3. Results and Discussion

3.1. Business Income

3.1.1. Gross Income

Gross income of respondents is visible in table 1. The data presented in table 1 shows that the intial population as many as 140 tails. In 2014 the cattle purchase is 110 tails, it also livestock sales is 75 tails and the last cattle population of respondents is 340 tails, which earned gross revenue of Rp 25.867.500/breeders/year.

Table 1. Gross Income (Gross Farm Income / GFI) Breeders

Variable	The number of Livestock (Tail)	Price Per Unit (Rp.)	Total price (Rp.)
The early population of cattle (-)	140	4.458.928,57	669.250.000
Purchase of cattle 2014 (-)	110	5.840.909,09	642.500.000
Cattle Sales 2014 (+)	75	6.085.000,00	456.375.000
The last population of cattle (+)	340	6.319.852,94	2.148.750.000
Total Gross Income (GFI)			1.293.375.000
The average of Gross Income (GFI)/breeder/ year GFI: 50 breeders			25.867.500

3.1.2. Operational Cost

Maintenance of cattle requires a certain operating costs to get maximum results. Business carried respondent spent a number of operational costs for first year as presented in Table 2. Operational costs include the cost of the cage with the economic life or the life of 8 years, the purchase and use of equipment (crescent, wheelbarrow, shovel and hoe) with a shelf life of 5 year, the purchasing fuel vehicles, additional feed, vaccinations, registration, treatment of diseases and electricity consumption. The data in Table 2 provides that on average the highest operating costs in the cost of vehiclfuel and electricity consumption costs. It can be explained that the stable owned by ranchers relatively more advanced because generally have gotten relatively adequate light.

Table 2. Operating Costs (Rp / year)

Cost	Total Cost (Rp.)
Cage	12.053.125
Equipment	2.247.000
Fuel Vehicles	43.500.000
feed Supplement	1.800.000
Electricity consumption	23.760.000
Vaccination	5.000.000
Registration	887.500
Treatment of Diseases	3.850.000
Total Operating Costs	93.097.625
Total Operating Costs / Breeder / Year	1.861.953

Vehicle fuel costs is the greatest costs in operating costs, this is due to the vehicle being used for finding and transporting feed in livestock enterprises is also used to somewhere else. The cost of power consumption is caused the average breeder becomes the respondent built the cages adjacent to their house so that the power consumption becoming one electics used at night.

3.1.3. Net Income (*Net Farm Income*)

Net income recipient of BLPM in Sumbawa is presented in the following description:

$$\begin{aligned} \text{NFI} &= \text{GFI} - \text{TFC} \\ &= \text{Rp. } 25.867.500 - \text{Rp. } 1.861.953 \\ &= \text{Rp. } 24.005.548, - \end{aligned}$$

So the net income (*Net Farming Income* / NFI) of respondents on average Rp. 24.005.548/respondent / year.

$$\begin{aligned} \text{Net revenue (net income)/breeder/month} &= \frac{\text{Total Net Revenue}}{12 \text{ month}} \\ &= \frac{\text{Rp } 24.005.548}{12 \text{ bulan}} \\ &= \text{Rp } 2.000.462/\text{breeder/month} \end{aligned}$$

Net income in farming as submitted by Soekardono (2009) is the difference between gross income and total expenses total farming. Net revenue for 1 year breeders respondents obtained net income (NFI) Rp. 24,005,548 / breeder / year or Rp. 2000462/breeder/month.

3.2. The Influence Independent Variables Against Livestock Revenue

To examine the factors that affect the income of the respondents used multiple linear regression, where that becomes the independent variable are the age of the farmer (X_1), education level (X_2), the experience of raising (X_3) and the number of dependents (X_4), while being the dependent variable is income (Y). Results of testing the factors that affect the income of the farmer as respondents can be seen in Table 3.

The accuracy of the model is reflected in the value of the coefficient of determination (R^2) the magnitude of 0,507. This means that changes in operating revenues BPLM recipient farmers in Sumbawa 50,7% influenced by the independent variable while the remaining influenced by other variables outside the model.

Table 3. Factors Affecting Breeders Income

Factor	Coefficient Regression	Std Error	t _{count}	Significance
Age (X_1)	- 2.1243,072	97.447,799	- 0,218	NS
Education level (X_2)	- 201.308,273	777.257,215	- 0,259	NS
Farming experience (X_3)	800.891,305	133.472,720	6,000	**
The number of dependents (X_4)	- 48.152,496	212.137,021	- 0,227	NS
Constants	1,956E7	5,956,031.452	3,284	
R^2	= 0,507			
F _{count}	= 11,584		T (0,05) = 1,679	
F (0.05)	= 2,58		T (0,01) = 2,410	
F (0.01)	= 3,77			

Based on Table 4 can be made simple equation with the following formula:

$$Y = 1,956E7 - 21243,072X_1 - 201308,273X_2 + 800891,305X_3 - 48152,496X_4 + \mu$$

Table 4 also shows that the factors of age, education level and number of dependents each have the tcount is smaller than ttable the means that statistically the factors of age, education level and number of dependents did not significantly affect the breeders income.

Meanwhile, the tcount on the raising experience factor greater than the value of ttable that means statistically the factor of raising experience are highly significant effect on operating income of breeders. Generally raising experience possessed by breeder was obtained from the parents for generations. Raising long experience gives an indication that the knowledge and skills of breeders on livestock maintenance management has a better ability. The results of the study to gain influence as expected, this caused many breeders who have adequate experience and using their experience in managing the business until now, so the results of this study in accordance with the opinion of Abidin and Simanjuntak (1997), the experience factor of breeders that very determining the development of the livestock business.

4. Conclusion

The conclusion of this study is that the business net income of the breeder that received the Direct Loan Aid Society (BPLM) in Sumbawa Regency is Rp 24.005.548/breeders/year or Rp 2.000.462/breeders/month. Which the factors have a real influence on the breeders income of BPLM recipient in Sumbawa District is only the a factor raising experience.

References

- [1]. Abidin, A. and Simanjuntak, D., 1997. *Beef Cattle*. Directorate General of Livestock. Jakarta.
- [2]. Ahmadi, AH, 2003. *Sociology of Education*. Publisher PT. Rineka Reserved. Jakarta.
- [3]. BPS Sumbawa, *Sumbawa in 2012. The 2012 figure*. BPS Sumbawa. Sumbawa.
- [4]. NTB Provincial Livestock Office, 2001. *Strategic Plan 2003-2007*. NTB Provincial Livestock Office. Mataram.
- [5]. NTB Provincial Livestock Office, 2005. *Implementation Guidelines BPLM 2005*. Provincial Animal Husbandry NTB. Mataram.
- [6]. Soekardono, 2009. *Agribusiness Economic Theory and Application*. Academica Pressindo. Jakarta.
- [7]. Soekartawi, A., et al., 1986. *Farming Science and Research for Development of SmallFarmers*. UI - Press. Jakarta.

Green Synthesis of Bio-degradable Superabsorbent Polymers from Carboxymethyl Cellulose/Humic Acid

Nurul Ismillayli^{1*}, Siti Raudhatul Kamali¹, Saprini Hamdiani¹, Surya Hadi¹, Dhony Hermanto¹

¹ Department of Chemistry, Faculty of MIPA – University of Mataram, Mataram

* Email: nurulismillayli_12@gmail.com

Abstract

Superabsorbent polymer (SAP) blend has been synthesized from carboxymethyl cellulose (CMC), humic acid, and aluminum sulphate octadecahydrate cross-linker. SAP is hydrophilic networks that can absorb and retain huge amount of water within their structures. Humic acid as starting material of polymer, was isolated from subgrade Batujai Dam by using IHSS method. Water Absorption Capacity (WAC), FTIR, and ignition tests are carried out to investigate the cross-linking process and which of Al^{3+} and SO_4^{2-} ions causes the crosslinking. Optimum cross-linking ratio of CMC and cross-linker appeared to be 2wt% corresponded to WAC determination. FTIR spectrum of CMC/humic acid blend showed that CMC react with humic acid during polymerization process.

Keywords: *carboxymethyl cellulose, crosslinking, humic acid, superabsorbent polymer*

1. Introduction

Recently interest in developing superabsorbent from biopolymer such as starch [1], cellulose and its derivatives [2], and chitosan [3] has been increased due to their exceptional properties compared to petroleum-based polymers that is sustainable, biocompatible, biodegradable, renewable and nontoxic [4]. Owing to their three-dimensional polymeric networks that can absorb and retain large volumes of water, superabsorbents are widely used in many fields, such as hygienic products, drug-delivery systems, agriculture and horticulture [5].

Superabsorbent prepared through electrostatic complexing can be used for example crosslinking of CMC/HEC [2] and CMC/starch [1] with aluminium sulphate as cross-linking agents. Aluminium sulphate, with its cationic species in effective form of Al^{3+} , $Al(OH)^{2+}$ and oligomeric species in aqueous solution when $pH < 5$, provides multivalent positive charges and abundant sites for crosslinking with anionic groups [6] such as NaCMC that containing –COO⁻ groups to form hydrogel structures.

Application of humic acids (HA, one of the main fractions of humic substances) in agriculture as soil fertilizer and soil conditioner has been extensively discussed in the literature [7]. Containing of carboxylic and phenolic groups, humic acid provides favorable conditions for chemical reactions, biological activity and improves physical structure of soil, water holding capacity, pH buffering and accelerate transport of nutrients to plants [8]. Therefore, it was planned to synthesize a biodegradable superabsorbent with suitable for soil water conservation by crosslinking CMC and humic acid with aluminum ions. Optimum cross-linking ratio of CMC and cross-linker, water absorption capacity and FTIR analysis were also studied.

2. Materials and Methods

Humic acid used in this study were isolated from subgrade Batujai Dam, Lombok

Tengah, Nusa Tenggara Barat. Analytical quality materials (analytical grade) for humic acid isolation include: NaOH (sodium hydroxide), HCl (hydrogen chloride), HF (hydrogen fluoride), AgNO₃ (silver nitrate), paper Whatman filter 42, pH indicator strip were obtained from Merck (Germany). Carboxymethyl cellulose sodium salt NaCMC aluminum sulphate octadecahydrate was used at reagent grade to crosslink the polymer complex.

2.1. Isolation and Characterization of Humic Acid

Humic acid isolated by using recommended method of the International Humic Substances Society [9]. Humic acid isolated then were characterized using FTIR spectroscopy.

2.2. Preparation of Cross-Linked CMC/HA Blend

Carboxymethyl cellulose sodium salt (10 g) was mixed with 1.0 L of distilled water (DW) in a large beaker using a magnetic stirrer. The solution was agitated for 1 hour at 70°C. Then varying amounts of aluminum sulfate were added to the beaker to investigate the optimum crosslinkage, and the solution was allowed to mix for another 30 min. The solution was then spread on Teflon baking pans and dried at 50°C until a film is formed. The film was shredded with a blender and then ground into a powder with a mortar and pestle. Dried film of the cross-linked CMC, was crushed and dissolved in DW. Using magnetic hot plate, humic acid solution mixed with the cross-linked CMC gelatinized for 30 minute at 70°C. Result paste was dried overnight at 50°C, crushed, and tested.

2.3 Water Absorption Capacity (WAC)

WAC was measured using tea-bag method according to the following equation :

$$W_{AC} = \frac{W_1 - W_0}{W_0} \quad (1)$$

Where W_0 is dry weight and W_1 is wet weight.

2.4 Investigation of the Active Ion

When aluminum sulfate octadecahydrate dissolve in water, the material dissociates into Al^{3+} and SO_4^{2-} . Investigating the ions which enters the cross-linking reaction has done by adopting following procedure: pieces of the cross-linked CMC/starch blend immersed in hot water 70°C for 30 minutes and then filtered. The extraction then divided into two parts. The first part is tested for sulfate group using BaCl₂ solution, while the second part is tested for Al^{3+} ion using NaOH solution.

3. Results and Discussions

3.1 Isolation and Characterization of Humic Acid

HA was obtained from subgrade Batujai Dam after separating its humin and fulvic acid then purifying by using mixed HCl/HF solution to dissolves silica oxide mineral. Based on interpretation of the FTIR spectra of crude and pure HA in Table 1 can be seen that purification decreased the ash content, indicated by decrease of SiO stretching in 914 cm⁻¹. Peak at 1388 cm⁻¹ coupled with 1659 cm⁻¹ peak suggests that crude HA has carboxylate groups, presumably because of the ash content [10][11]. The peak was shifted to 1381 and 1653 cm⁻¹ respectively after purification of HA. Intensity of this peak was decreased, while peak intensity around 1722 cm⁻¹ increased at pure HA spectra due to carboxylate to carboxylic changes in HA. This is supported by result of ash content determination that purification decreased ash content from 5.60% to 1.13%. Based on FTIR spectra, HA isolated

containing functional groups of COOH, phenolic –OH, aliphatic hydrocarbon and aromatic ring.

Table 1 Interpretation of the FTIR spectra of HA

HA before purification (cm ⁻¹)	HA after purification (cm ⁻¹)	Vibration Type
3425	3408	OH stretching of alcohols or phenols
2927	2927	asymmetric stretching of aliphatic C-H in –CH ₂ - groups
2851	2851	symmetric stretching of aliphatic C-H in –CH ₂ - groups
1728	1722	C=O stretching (carboxylic and carbonyl group)
1659	1653	aromatic C=C and asymmetric C=O stretching in COO ⁻ groups
1564	1552	nitro groups
1463	1457	methyl asymmetric C-H bending
1388	1381	OH deformation and C-O stretching in phenols and COO ⁻ groups
1255	1236	groups
1035	1035	C-O stretching of aryl ethers and OH deformation of COOH groups
914	914	groups
700	700	C-O stretching (alcohols and polysaccharide)
529-473	524-466	SiO stretching ortho disubstituted out-of-plane = C-H bending vibration metal-humic acid interaction

3.2 Proposed Interaction of cross-linked CMC/HA-Al³⁺

In order to suggest a reasonable interaction, knowing which ions enters the cross-linking reaction (Al³⁺ or SO₄²⁻) is needed. Tested for sulfate group using BaCl₂ solution on extraction of cross-linked CMC/AH, shows dense white precipitate indicated that the sulphate group not share for blend formation. While, tested for Al³⁺ ion using NaOH solution on extraction of cross-linked CMC/AH, shows the absence of Al³⁺ ion, which indicates that the Al³⁺ ion share in the blend structure. To confirm this result, FTIR analysis was done. The IR spectra of the HA, CMC, and CMC/HA blend are shown in Fig. 1 (a–c), respectively.

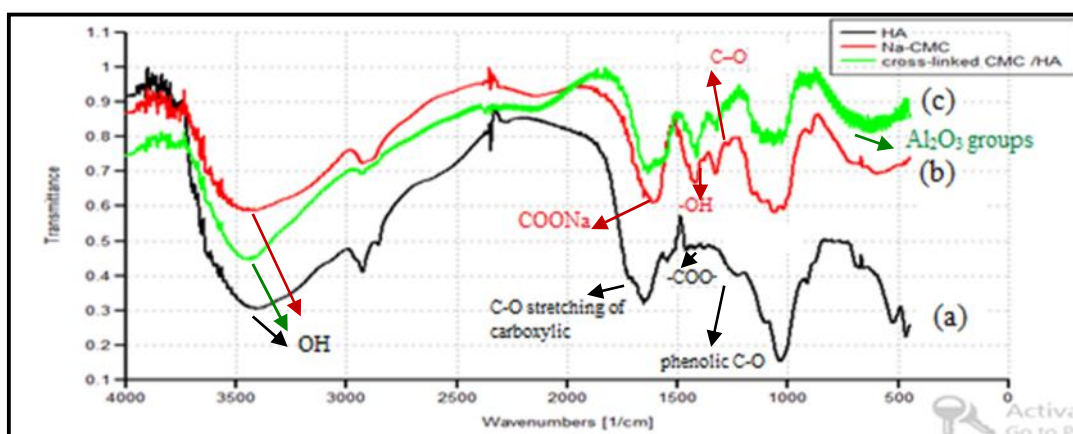

Figure 1 FTIR spectra of HA(a), CMC (b), and CMC/HA blend (c)

Comparing with the IR spectrum of CMC (Fig. 1(b)), the absorption bands at 1608 cm⁻¹ for the –COONa group shift to 1634 cm⁻¹, and the absorption bands at 1381 (OH bending vibration) and 1268 cm⁻¹ (C–O stretching) disappeared in the IR spectrum of cross-linked CMC/HA (Fig. 1(c)). Comparing with the IR spectrum of AH (Fig. 1(a)), the absorption bands at 3413 and 1653 cm⁻¹ for the –OH stretching of alcohols or phenols group and C=O stretching in COO⁻ groups shift to 3451 and 1634 cm⁻¹ respectively and the absorption bands at 1722 cm⁻¹ (C-O stretching of carboxylic group of AH), 1381 cm⁻¹ (–COO

asymmetric stretching of AH) and 1255 cm⁻¹ (phenolic C–O stretching of AH) disappeared in the spectrum of cross-linked CMC/AH superabsorbent (Fig. 1(c)). The results obtained from IR analysis showed that the reaction of both CMC and AH occurs in carboxylic and phenolic groups of HA and –COONa groups of CMC via Al³⁺ as cross-linker.

3.3 Optimum Cross-Linking Ratio

The effect of the amount of Al³⁺ on WAC was shown in Fig. 2. The max. of absorbency was at 2% of Al³⁺. Increasing cross-linker could increase the nodes of network and the cross-linker density, which is favorable to the super-absorbent absorbing and retaining fluid [12]. Low concentration of the cross-linker leads to low degree of cross linking, and it is hard for network structure to form, so the water absorbency is low. However, when it is higher than the best value, there are more cross-linking points and the pores become smaller in the network, which causes the macroscopic decrease of the absorbency [13].

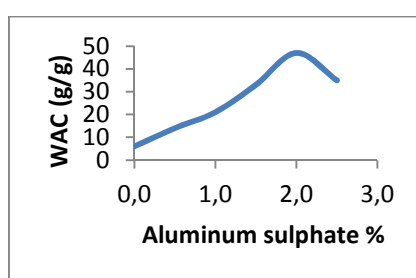

Figure 2. Optimum percent of aluminum sulphate octaadekahydrate cross-linker

4. Conclusions

A superabsorbent was successfully prepared using the cross-linking of CMC/HA with aluminum ions. The interaction was occurs in carboxylic and phenolic groups of HA and –COONa groups of CMC via Al³⁺ as cross-linker. The mass ratio of Al³⁺ to CMC could affect its water absorption capacity.

Acknowledgements

This work was financially supported by DIPA BLU (PNBP) Universitas Mataram Project.

References

- [1] AJ. Braihi, SI. Salih, FA.Hashem, J K.Ahmed, *International Journal of Materials Science and Applications*, 3(6), 363-369 (2014), doi: 10.11648/j.ijmsa.20140306.23
- [2] Y. Liu, Y. Chen, Y. Zhao, Z. Tong, and S. Chen, *BioResources* 10(4), 6479-6495 (2015).
- [3] HC. Ge, W. Pang and DK. Luo, *Carbohydr. Polym.*, 66(3), 372-378, (2006).
- [4] M. Sadeghi1 and M. Yarahmadi, *African Journal of Biotechnology*, Vol. 10(57), 12265-12275 (2011).
- [5] F. Nnadi and C. Brave, *Journal of Soil Science and Environmental Management*, 2(7), 206-211 (2011).
- [6] S. Bi, C. Cao, C. Zhang, *Cooordination Chemistry Reviews* 248, 441-455, doi: 10.1016/j.ccr.2003.11.001
- [7] D. Hermanto, SR. Kamali, R. Kurnianingsih and, N. Ismillayli, *Sains Tanah – Journal of Soil Science and Agroclimatology*, 10 (2), 21-32, (2013)
- [8] SM. Ibrahim, FI. Abou El Fadl and AA. El-Naggar, *Journal of Radioanalytical and Nuclear Chemistry* 299(3), 1531-1537 (2014). doi: 10.1007/s10967-013-2820-4
- [9] International Humic Substances Society, 2008, <http://www.ihss.gatech.edu>
- [10] M.Takács, and JJ. Alberts, *Changes in Chemical Composition, FTIR and Fluorescence Spectral Characteristics of Humic Acids in Peat Profiles*, edited by EA Ghabbour, and G. Davies, The Royal Society of Chemistry, 1999, pp 171-172.
- [11] N. Ismillayli, SJ. Santosa and D. Siswanta, *Jurnal Pijar MIPA*, 10(2), 18-21 (2015).
- [12] A. Pourjavadi and GR. Mahdavinia, *Turk. J. Chem.* 30, 595–608, (2006).
- [13] Z. Ma, Q. Li, Q. Yue, B. Gao, X. Xu, Q. Zhong, *Bioresource Technology*, 102, 2853-2858, (2011).

Shear Design of Reinforced Concrete Beam Using Steel Truss Encased in Flexural Plastic Hinge Zone

Fatmawati Amir^{1,2*}, Iman Satyarno², Djoko Sulisty²

¹Civil Engineering Department of Tadulako University, Palu, Indonesia

²Civil and Environmental Engineering Department of Gadjah Mada University, Yogyakarta, Indonesia

* Corresponding author: fatmastructureuntad@gmail.com

Abstract

The behavior of structures that are shear-critical under seismic load conditions has not been well studied, unlike with moment-critical structures, where shear-critical failures are usually associated with much less forgiving brittle mechanisms and little forewarning. A number of researches about various methods to increase the shear capacity of structural members in flexural plastic hinge zone were investigated, the type of methods are summarized in various amount of shear stirrups, arrangement of shear stirrups, various ratio of shear length to depth of cross section, the length of longitudinal bar anchorage, and steel shape encased in concrete. Refer to previous researches that utilizing of various designs of structural members in plastic hinge zone to increase its shear capacity, to ensure the energy dissipated and ductility of structures. But still there are some weaknesses due to inadequate designs of shear-critical reinforced concrete. With the simplifying assembling and the ductile performance of steel, it is proposed to embedded a steel truss in plastic hinge zone of reinforced concrete as a shear reinforcement, improve concrete prosperity, enhance shear capacity and ductility of structural members. In this paper, a proposal for shear design using steel truss in flexural plastic hinge zone of reinforced concrete will developed and discussed.

Keywords : *shear-critical reinforced concrete, flexural plastic hinge, steel truss*

1. Introduction

Inelastic cyclic loading on reinforced concrete structures, which may occur in ductile frame under severe seismic loading can lead to yielding of reinforcement, and causes shear deformation develop in plastic hinge zones of beams and columns. Most of stiffness degradation caused by the development of shear deformation in these zones. The deformation, in a practical design is sometimes ignored, so it can greatly affect the forces distribution in the structure and its ability to survive without collapse. Critical areas along the plastic hinge are generally dominated by high shear and exhibit brittle failure mechanism (Figure 1) . where shear-critical failures are usually associated with much less forgiving brittle mechanisms and little forewarning.

Shear deformation due to increased of flexural ductility causes shear strength degradation in the plastic hinge zones as a result of nominal shear stress reduction detained by the concrete due to large shear strength. Therefore, nominal shear stress can be resisted by the concrete elements decreases with increasing flexural ductility imposed by cyclic loading.



Figure 1. Typical shear failure on beam due to seismic loading : (a) in Turkey, 2003; (b) at The Grand Chancellor Tower in *South Island*, NZ, 2011
<http://www.koeri.boun.edu.tr>; <http://db.concretecoalition.org>

. Flexural ductility increases (Figure 2) causes the degradation of shear strength in the plastic hinge zones, reinforced concrete beam section will cracks and spread as soon as possible, resulted in shear failure of beam, in Figure 2 the degradation of shear strength values symbolized by a factor k is equal to 0.20 in calculating V_c (or $k = 0.17$ by Equation 11-3 and 11-4 section 11.2.1 SNI 2847:2013).

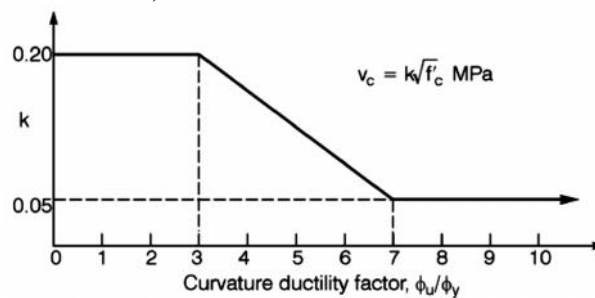

Figure 2. Degradation of nominal shear stress resisted by the concrete with imposed cyclic curvature ductility factor

2 Previous Researches on Shear Capacity in Plastic Hinge Zones

Various studies on shear design in the plastic hinge member to reduce shear deformation cause of flexural ductility of reinforced concrete members has been perform by several researchers, among others by Rhomberg, 1963; Celebi and Penzien, 1973; Schribner and Wight, 1978; Fenwick, 1983; Fenwick et al, 1999; Pan and Li, 2013. From the results of these studies showed that the stiffness and the shear strength decrease progressively in reinforced concrete, although the number and diameter of the transverse bar can ensure sufficient and confined concrete core capabilities in resisting shear imposed by cyclic loading. Its indicates that the configuration of transversal bars likely not reduce the shear degradation due to increased of flexural ductility in reinforced concrete members.

Alternative shear design that has been study to reduce the ductility of flexural reinforced concrete structures is the addition of steel profiles into reinforced concrete /steel shape encased in concrete (Khuntia and Goel, 1998, 1999; Weng et al, 2001, 2002 and Deng, 2015). The results of the investigation show that the composite steel encased has excellent ductility and strength if restraints on concrete core around profile insufficient in areas of flexural plastic hinge.

Based on the experimental and analytical studies about the different various method in

shear design of reinforced concrete members can be concluded that the shear design currently not sufficient to reduce the degradation of the shear strength in plastic hinge regions significantly due to the reduction of the nominal shear stress V_c resisted by the concrete mechanisms. In addition, the shear design has difficulties to applied in rural Indonesia area cause of the cost factor and congestion that may affect the constructibility. As a result, the research on shear design of beam using a steel frame in flexural plastic hinge zone developed and made as an alternative design by encased a steel frame in flexural plastic hinge of reinforced concrete members.

The steel frame is made and formed from a steel plate and configured by a certain height and spliced with diagonal steel bar. Steel plate is used to facilitate the casting of concrete and provide additional flexural strength in reinforced concrete beams, while diagonal bar as a fitting steel plate and serves to maintain the shear strength of concrete and providing a shear force to arrest a large shear imposed by cyclic loading ,

3 Shear Design of Reinforced Concrete Beam Using Steel Truss Encased in Flexural Plastic Hinge Zone

According to SNI 2847:2013, design of cross sections subject to shear shall be based on :

$$\phi V_n \geq V_u \quad (1)$$

Where shear reinforcement perpendicular to axis of member is used,

$$V_s = \frac{A_v f_{yt} d}{s} \quad (2)$$

where A_v is the area of shear reinforcement within spacing s , V_u is the factored shear force at the section considered and V_n is nominal shear strength calculated by,

$$V_n = V_c + V_s \quad (3)$$

Where, V_c is the nominal shear strength provided by the concrete beam which is calculated as follows:

$$V_c = 0,17\lambda\sqrt{f'_c} b_w d \quad (4)$$

Where, f'_c is the compressive strength of concrete, b_w is the width of the beam section and d is the effective height of the beam section.

4 Proposed design of shear using a steel frame in flexural plastic hinge zones

Design concept of the beam with a steel frame is by adding steel frame (Figure 3) into a reinforced concrete beam.

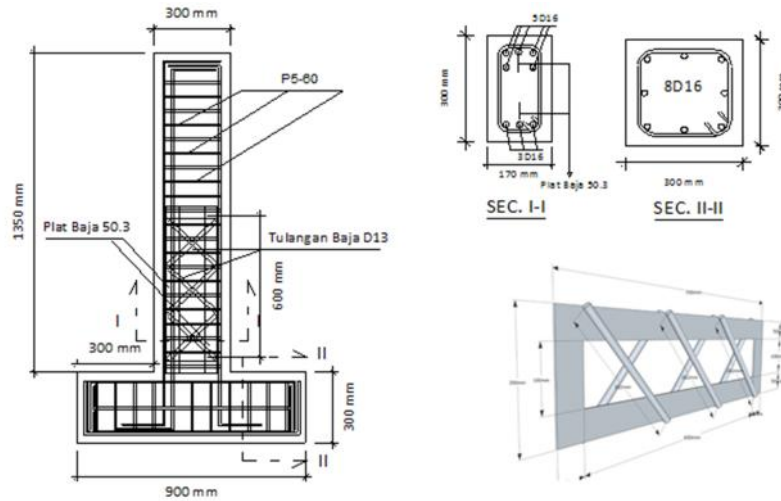

Figure 3. Proposed design of shear by embedded a steel frame in flexural plastic hinge zones

In this design, the magnitude of the shear strength, V_u provided by the concrete, V_c (Eq. 4), transversal bar, V_s (Eq. 2) and diagonal steel bar, V_t which is calculated based on the yield strength of diagonal bar, f_y where as :

$$V_u = V_c + V_s + V_t \quad (5)$$

And V_t , calculated as follow,

$$V_t = A_t f_y \quad (6)$$

Where, V_t : Steel frame shear force (kN), $A_t = 0,25 D^2$ (mm²) and D : diagonal bar diameter (mm)

Shear strength provided by steel plate (Eq. 6) should be made larger than the shear forces provided by diagonal steel bar, shear provided by steel plate representing by the following equation,

$$V_{pt} = A_{pt} f_y \quad (7)$$

Where, V_{pt} : Shear provided by steel plate (kN), $A_{pt} = bt$ (mm²), b : width of plate (mm), t : plate thickness (mm).

Shear design using a steel frame calculated by assuming a large shear force provided by the steel frame modifications, V_t the same or close to the shear forces provided by concrete, V_c , and the value of V_c taken equal to zero.

5 Summary and Conclusion

It can be concluded from above description and subsequently can be important to be solved for further studied. The important points are :

1. The shear design currently not sufficient to reduce the degradation of the shear strength in plastic hinge regions significantly due to the reduction of the nominal shear stress V_c resisted by the concrete mechanisms,
2. Base on SNI 2847: 2013, for the structural system of fexural frame special moments, shear strength provided by the concrete taken equal to zero and the overall shear forces should be resisted by transversal bar, so we need transversal quite a lot and more close at flexural plastic hinge reinforced concrete. It implicated to the construction costs and congestion that may affect the constructibility;
3. New alternative shear design of reinforced concrete beams using steel frame encased in flexural platic hinge zone is expected to be able to resist high shear loads developed in the

structural members imposed by cyclic loading and as reference material for revision of the seismic provisions in the future.

References

- [1] Fenwick, R.C., 1983, "Shear Deformation in Seismic Frame Structures", *Journal of Structural Engineering*, ASCE, Vol. 109, no. 4, pp. 965-976.
 - [2] Fenwick, R.C., Dely, R., Davidson, B., 1999, "Ductility Demand for Uni-Directional and Reversing Plastic Hinges in Ductile Moment Resisting Frames", *Bulletin of The New Zealand Society for Earthquake Engineering*, Vol. 32, No. 1, March, pp. 1-12.
 - [3] Khuntia, M. dan Goel, S.C., 1998, "FRC-Encased Steel Joist Composite Beams under Reversed Cyclic Loading", *Journal of Structural Engineering*, ASCE, Vol. 124, no. 10, pp. 1115-1124.
 - [4] Khuntia, M. dan Goel, S.C., 1999, "Experimental study of FRC-encased steel joist composite beams", *Journal of Structural Engineering*, ASCE, Vol. 125, no. 5, pp. 495-502.
 - [5] M.D.Cahyati, *Perilaku geser pada balok castellated modifikasi komposit mortar profil double siku dengan diagonal silang baja tulangan akibat beban siklik*, Tesis S2, Teknik Sipil UGM, Yogyakarta, Indonesia, 2015.
 - [6] Pan, Z. dan Li, B., 2013, "Truss Arch Model for Shear Strength of Shear Critical Reinforced Concrete Columns." *Journal of Structural Engineering*, ASCE, Vol. 139, no. 4, pp. 548-560.
 - [7] Rhomberg, E. J., 1963, "The Effect of Combined Moment and Shear on The Formation of Plastic Hinges in Reinforced Concrete Beams", Ph.D Thesis, Iowa State University of Science and Technology, Civil Engineering, University Microfilms, Inc. Ann Arbor, Michigan, Retrospective Theses and Dissertation, paper 2491.
- R.Park, T. Paulay, *Reinforced concrete structures*, John Wiley and Sons Inc, New York, 1974
- [9] Scribner, C.F., Wight, J. K., 1978, "Delaying Shear Strength Decay in Reinforced Concrete Flexural Members Under Load Reversals", UMEE 78R2, The University of Michigan, Department of Civil Engineering, Ann Arbor.
 - [10] SNI 2847:2013, *Persyaratan Beton Struktural untuk Bangunan Gedung*, BSN, Jakarta, 2013.
 - [11] T. Paulay, M.J.N. Priestley, *Seismic design of reinforced concrete and masonry building*, John Wiley and Sons Inc, New York, 1992.
 - [12] Weng, C. C., Yen, S. I. N., dan Chen, C.C., 2001, "Shear strength of concrete-encased composite structural members", *Journal of Structural Engineering*, ASCE, Vol. 127, no. 10, pp. 1190-1197.
 - [13] Weng, C. C., Yen, S. I. N., dan Chen, C.C., 2002, "Experimental study on shear splitting failure of full-scale composite concrete encased steel beams", *Journal of Structural Engineering*, ASCE, Vol. 128, no. 9, pp. 1186-1194.

Design of Seismic Recorder with Single-Axis Geophone for Passive Seismic Monitoring

I Wayan Sudiarta^{1*}, Raja Fathurrahman Akmaludin¹, Dian Wijaya Kurniawidi¹, Made Sutha Yadnya²

¹ *Physics Study Program, Faculty of Mathematic and Nature Sciences, the University of Mataram Mataram, NTB, Indonesia*

² *Department of Electrical Engineering, Faculty of Engineering, the University of Mataram, Mataram, NTB Indonesia*

* Email: wayan.sudiarta@unram.ac.id

Abstract

Seismic events such as earthquakes have influenced our life. To monitor seismic events requires a seismic recorder that consists of five parts : (1) a single axis geophone with natural frequency of 1 Hz, (2) a signal conditioning circuit, (3) an ADC circuit, (4) an RTC circuit and (5) an SD logger circuit. Simple test have shown that our seismic recorder can record seismic waves up to 70 samples per second, and with amplification of 1400 times. Seismic monitoring for two weeks in the City of Mataram have shown that seismic waves are clearly shown and produced by human activities during the night and the day, and natural phenomena such as earthquakes. Analysis of P and S waves of two earthquakes that happened during time of the seismic monitoring have shown that the distance of the epicenters of the earthquakes are obtained to be in agreement with epicenters provided by the Indonesian Agency for Meteorology, Climatology and Geophysics (BMKG).

Keywords: *Seismic recorder, Single-axis geophone*

1. Introduction

Seismic waves in the earth crust are, for examples produced by the movement of tectonic plates, human activities, tides and winds. Characteristics of seismic waves can be used to determine subsurface structure of the earth. One can use active seismic sources (known as the active seismic method) and natural seismic sources (the passive seismic method) [4]. To record natural seismic vibrations, a passive seismic recorder is needed.

The conventional seismograph which used is a seismograph with short-time records, its only capable to short-term record. The main purpose of this study is to produce a device with single-axis geophones that is capable of recording natural seismic activities for a long period of time [1], it is low cost and low power device. This device is then applied to record seismic waves in the City of Mataram.

2. Material and Methods

2.1 Related Work

Study on a design of the device for the detection of passive seismic phenomena such as earthquakes was conducted by Zhang [8] for a design geophone to detect an earthquake using MEMS. Application for monitoring volcanic activity with wireless sensor network (WSN) was done by Werner-Allen et. al [6]. A study to determine locations of hydrocarbon was also conducted by Mohammed [3].

2.2 Hardware Design

The seismic recorder consists of a single axis geophone LF-24, a signal conditioning circuit (see Fig. 1 (a)), Data logger shield, an Arduino Mega, an ADC circuit ADS 1115.

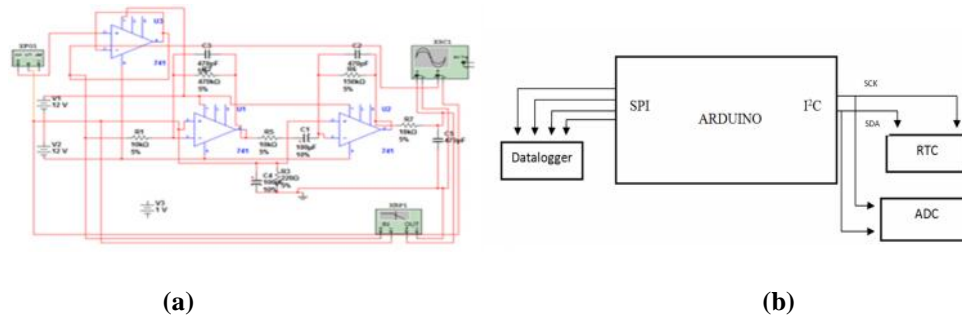

Figure 1. Single-axis system (a) signal conditioning circuit for the seismic recorder (b) conceptual diagram system

2.3 Single-axis Geophone System Design

The design of signal conditioning using operational amplifier with active filter system and strengthening, besides signals conditioning are also converted signal using a ADC ADS1115 with 16 bit resolution. The design of the signal conditioning can be seen from Figure 1 (a) with reinforcement cascade and band-pass filter [2]. Then for the system design and system timer recording (see Fig. 1 (b)) using the data logger shield with the type of communication with arduino using SPI for recording system and I²C timer system.

2.4 System Testing and Data Retrieval

System testing is done to determine whether the system is designed to work in accordance with the draft, testing of the system consists of laboratory testing. The analysis procedure for recording data on a long-term passive seismic activity starting from obtained data recording for one week, data generated some files that are the result of recording per hour for one week, and then merge the files according to the recording time. Results of one week of data is then processed using Matlab with STFT methods to see the difference frequencies occur at any time. Then, with the data STFT characterization was carried out to see phenomena that occur during recording [5].

3. Result and Discussion

Results single-axis system design geophone can be seen in Figure 2 (a) consists of signal conditioning, system timer and recording system.

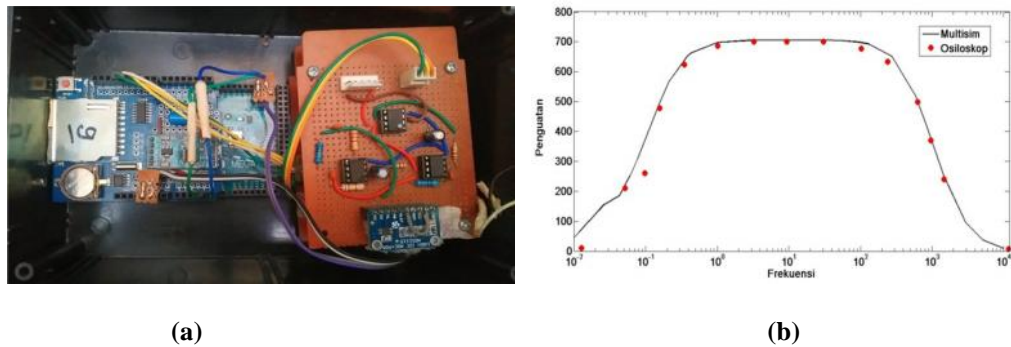

Figure 2. System results (a) Single-axis geophone design result (b) bode diagram result

Signal conditioning consists of active filter, amplifier and ADC, timer and recording system designed using data logger module shield and Arduino as the controller system. The results of the design to produce systems that are capable of storing and managing time digital. The results of the input signal conditioning to arduino then processed and determined when the signal came by RTC and recording systems store data signal recording and time data from the RTC and then storing them in SD-card.

3.1 Design Testing Result

System testing is done on a laboratory scale and outside testing, the purpose of this test is that the designed system capable of recording seismic waves passive. Single-axis system testing geophone testing laboratory scale to the signal conditioning, ADC, timer systems and recording systems. Testing signal conditioning bode diagram band pass filter using multisim with cut-off frequencies between 0.345 Hz and 270.081 Hz and gain 706.042 times. The results obtained from the program multisim compared with the results of measurements with the oscilloscope showed in Figure 2 (b), the results were very close to the simulation results with multisim with cut-off frequency of 0,351 Hz - 240.08 Hz.

3.2 Long Term Record Result

Long-period recording seismic activity aims to record human activity and activity within one week, Figure 3 is a spectrogram of recording results for one week.

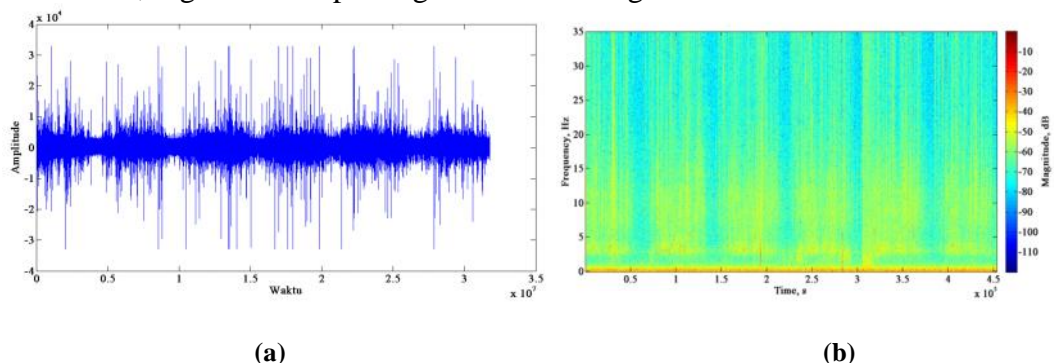

Figure 3. Long-term record results (a) one week record signal results (b) one week record spectrogram results

Long-term passive seismic recording there are several phenomena such as earthquakes recorded, the activity of motor vehicle traffic and activities in the morning and evening. Figure 4 (a) and Figure 5 (a) shows the phenomenon of earthquakes and the time recorded on

Thursday 9 June 2016 at 10:41 wita and 12:13 wita, it corresponds to the time recorded by BMKG time of occurrence of the phenomenon of earthquakes.

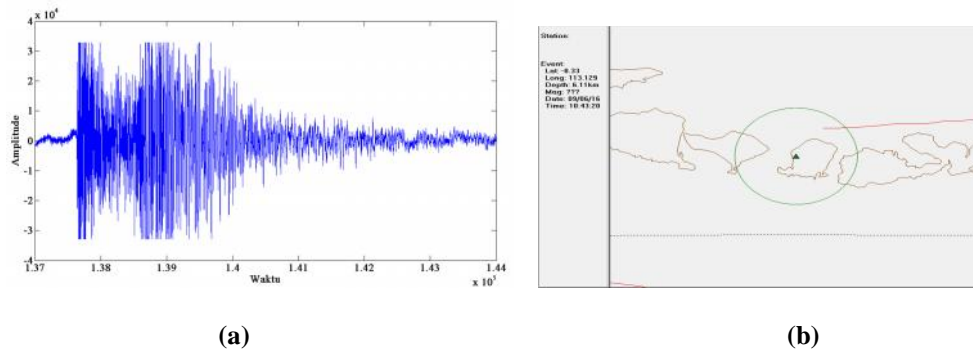

Figure 4. Earthquake event (a) earthquake record at 10:41 wita (b) Epicenter result for earthquake record at 10:41 wita

Results picking seismic wave in Figure 4 (a) was difference in arrival time for the P and S waves which is 12 seconds, to determine the distance of the epicenter resulting from the earthquake epicenter distance [7] is 100.8 Km (see Fig. 4 (b)) from geophone.

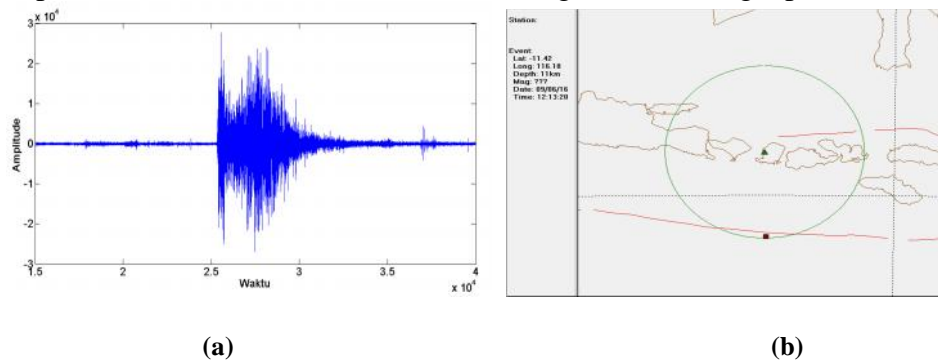

Figure 5. Earthquake event (a) earthquake record at 12:13 wita (b) Epicenter result for earthquake record at 12:13 wita

The quake, which occurred at 12:13 wita showed great magnitude so as to obtain arrival time differences for P and S waves are used digital filter to smooth the result of the recording of Figure 5 (a) is obtained wave arrival time difference of 39 seconds obtained epicenter of the earthquake [7] is 327.6 Km (see Fig. 5 (b)) from geophone.

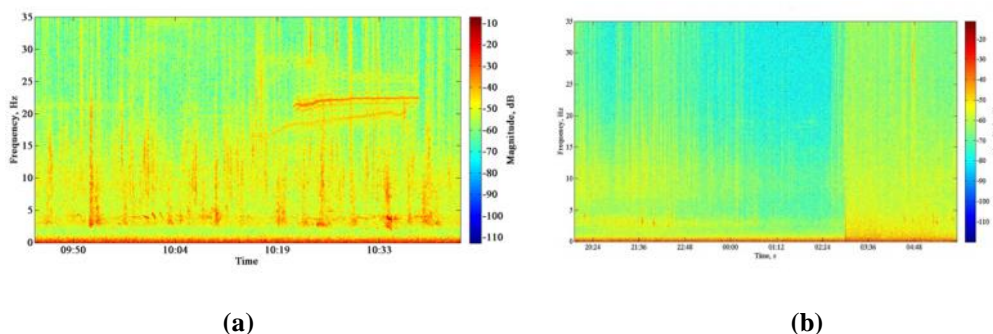

Figure 6. Human Activity (a) human activity spectrogram results (b) human activity in day and evening results

Seismic activity caused by humans in general can be seen in Figure 6 (b) it's at 03:00 wiita humans activity started, this is indicated by an increase in magnitude at all frequencies

recorded. Human activity is a motor vehicle passing near the geophone can be shown in Figure 16, where the horizontal red line at a frequency of 20Hz - 23Hz, it is repeated every day at 10:00 wita to 11:00 wita and 04:00 wita. to 18:00 wita.

4. Conclusions and Future Work

Based on the result of design and recording 1-axis geophones, it can be concluded that design and testing single-axis geophone can perform passive seismic activity with frequency between 0.325 Hz and 270,364 Hz, gain by 1400 and sampling record 70 Hz and recording long-term passive seismic activity obtained natural phenomena such as earthquakes with epicenter distance 100.8 Km and 361,2 Km, also record human activity.

For development single-axis geophone system is necessary to improve its system in higher and faster data processing using raspberry pi, high-resolutions ADC 24-bit and IOT-based to facilitate data recording, also apply to volcano monitoring and measure the building motions.

References

- [1] Bowness, D and Lock, A C., 2007, Monitoring the Dynamic Displacement of Railway Track., *proceeding of the institution of mechanical engineers, part F : journal of rail and rapid transit*
- [2] Haskov, J and Gerard . W., 2004. *Instrumentations In Earthquake Seismology*. Springer : Dordrecht, Netherlands.
- [3] Mohammed, Y, 2009 . *Low-frequency passive seismic experiments in Abu Dhabi, United Arab Emirates: implications for hydrocarbon detection*. The Petroleum Institute. UEA.
- [4] Sheriff, R. E., and Geldart, L. P., 1995. *Exploration Seismology 2nd Edition*. Cambridge University Press: New York. USA.
- [5] Walker, D. 2008, *Recent developments in low frequency spectral analysis of passive seismic data*. First break, 26, 67-77.
- [6] Werner-Allen, G. Johnson, J. Ruiz, M. Lees, J. Welsh M., 2005 ,Monitoring volcanic eruptions with a wireless sensor network, *Wireless Sensor Networks, Second European Workshop*, Harvard University., Boston, MA, USA.
- [7] Wood, M. M. (2007, April 16). *UPseis*. Retrieved June 5, 2016, from Michigan Tech: <http://www.geo.mtu.edu/UPSeis/locating.html>.
- [8] Zhang Xiaodan, Ke Xizheng, Zhang Zhiyu, 2010, Research on Micro-Electro-Mechanical-Systems digital geophone, *International Conference on Artificial Intelligence and Computational Intelligence*, Beijing, China.

Study of Livestock Behavior Relationship in Cage Environmental Sanitation Management with Suspect of Scabies Disease

Mujahid Fitriadi^{1*}, Sukardono, Made Sriasih²

¹Master Program of Animal Husbandry Faculty, University of Mataram, ²Lecturer of Animal Husbandry Faculty, University of Mataram

*Email : mujafatriadi1234@gmail.com.

Abstract

In district of Kediri in 2015, the scabies disease in cattle reported 54 cattles that are mostly located in the village of Lelede with a total of 25 cattle and all the goats and cases of skin infections including scabies has contributed quite high, 2,847 cases (Health Department of West Lombok 2015). The aim of this research was to find out the behavior of farmers in the management of environmental sanitation cage with suspected scabies. This research is descriptive analytic study, the population is farmers in the village Lelede district of Kediri, sampling techniques using systematic random sampling, with 84 respondents, the techniques of data analysis by chi square test. Based on the research results obtained level of knowledge about the management of environmental sanitation skable is good (61.9%), the respondents' attitudes hesitant towards environmental sanitation management in cage (48.8%) and respondents largely action managing environmental sanitation cage (57 , 1%). From the results, the suspect scabies 26 of 84 respondents (30.95%). Results of statistical test Chi Square correlation between knowledge of respondents with suspected scabies is derived indigo $p = 0.280 > 0.005$ indicates no correlation, statistical result ties the action of respondents with suspected disease scabies obtained value of $p = 0.298 > 0.005$ showed no correlation and statistical result relation actions respondents with suspected disease scabies obtained value of $p = 0.014 < 0.005$ indicates no relationship. The conclusions of research there is no relationship of knowledge and attitudes of respondents to the environmental sanitation management cage with suspected disease scabies but there is a relationship between the actions of the respondents in the management of environmental sanitation cage with suspected disease scabies.

Keywords: *Behavior, sanitary cage, suspected scabies*

1. Introduction

One of the diseases problems is the disease of infectious skin disease (scabies). Scabies disease mite infestations due to a parasite of animals by name *Sarcoptes scabiei* (*S.scabiei*) type hominis, or attack humans. In Indonesia, the prevalence of scabies is still quite high, according to the Department of Health (2008), the prevalence of scabies in Indonesia amounted to 5.60 to 12.95%, and scabies is the third of the 12 most common skin disease (Azizah and Setyowaty, 2011). There are many factors that support the development of the scabies disease include a decline in the body's immunity as a result of the Human Immunodeficiency Virus (HIV), low socio economic, poor hygiene, sexual promiscuity nature (Murtiastutik, 2009). Also added by Handoko (2009), the factors that support the development of the disease scabies is an environment that is not clean, behavior support, fault diagnostics and the development of demography and ecology.

Baur et al. (2013) reported a factor of personal hygiene, water supply, socio economic status influence the prevalence of scabies in India. Advance prevalence of scabies among

other factors caused by high humidity, poor sanitation, overcrowding, malnutrition (Onayemi, 2005) and poor personal hygiene, knowledge, attitudes and behaviors that are less supportive of healthy lifestyles (Ma'rufi, 2005).

In the district of Kediri Regency West Lombok in 2015, the disease scabies in cattle reported 54 cattles which are mostly located in the village of Lelede with a total of 25 cattle and all the goats. Similarly, infectious skin diseases, West Lombok in 2014 some 17 886 cases increased in 2015, namely 27 365 cases, in the district of Kediri cases of skin diseases, including scabies infection has contributed quite high at 2,847 cases. The results of the examination and sanitary conditions within the cage to cage housing in the village Lelede data obtained stable conditions do not meet the health requirements of 53.8%.

2. Materials and Methods

This research was conducted in March until June, 2016 in the village of Lelede district of Kediri Regency West Lombok. This type of research is descriptive analytic with cross sectiona, data collection is done through face to face interviews with the help of a questionnaire. The data obtained were collected and conducted assessment or scoring on a questionnaire. The data were analyzed using univariate to obtain the percentage of respondents by age, gender, type of education and the percentage of each level of Knowledge, Attitudes and Actions of the respondents. The variables were observed in this study are grouped into two independent variables (independent variable) consists of knowledge, attitudes and actions breeder of respondents to the management of environmental sanitation skable and dependent variable (dependent variable) is the presence or absence of a disease suspected of scabies in breeder respondents. The behavior of respondents in the study is analyzed using SPSS software tools for windows 17 and to determine its relationship with the suspected disease scabies was analyzed by chi square.

3. Results and Discussion

The level of knowledge of farmers in sanitation management skable majority are at a good level of knowledge that 52 of 84 respondents (61.9%). Mubarrak (2009) and Notoatmodjo (2010) says that one of the factors that can affect a person's level of knowledge is experience and age. When viewed from the distribution of respondents by age showed the majority of respondents are farmers with productive age of between 31- 40 years as many as 48 of the 84 respondents (57.14%). Distribution of the respondents indicate that the respondent is a group of people who have a mature age, where they already have good reasoning skills in understanding information on management of environmental sanitation cage. Similarly, with experince in raising the majority of respondents experienced more than three years that 56 of 84 respondents (66.67%), in line with the proposed Soekanto (2002) that the knowledge gained from the information either orally or in writing of a person's experience.

The attitude of farmers in the management of environmental sanitation skable most respondents expressed hesitation in the environmental sanitation skableby 41 of the 84 respondents (48.80%). The higher the level of education a person more accepting of information that many knowledge (Effendy, 2008). The low educational level of farmers led to awareness attitude towards the environment is also low, the education level of respondents are mostly elementary education or equivalent ie 42 respondents (48.81%), this causes the respondents' attitudes hesitation in the management of environmental sanitation cage.

Respondent action in the management of environmental sanitation skable most of the acts of respondents do not take action against the management of environmental sanitation

skable that 48 of 84 respondents (57.1%), it can be concluded that the efforts of acts or activities of farmers in the management of environmental sanitation skable still short of the expectations in whole to support a healthy environment. According Notoatmodjo (2007) the behavior itself is influenced by several factors, namely: enabling or supporting factors, manifested in the physical environment, provided or unavailability of facilities or means of support. From the research results in detail that the unavailability of respondents facility or means of support such as unavailability of sewage management (19.7%), unavailability of waste water management (18.0%) and lack of shelter animal waste (12.6 %).

Based on the test results of chi-square statistic in getting p value is 0.280 which shows that the value of > 0.05 , this means there is no significant relationship between farmers knowledge in environmental sanitation management cage with suspected scabies. Along expressed Notoatmodjo (2007) that knowledge or cognitive domain is very important for the formation of a person's actions. knowledge of the respondents in general to reach the phase level of know (know) and understanding (comprehension) skable environmental sanitation management, defined as the ability to understand correctly describe about the object known, and can correctly interpret the material.

The result of chi-square statistic about the attitude obtained p value is 0.298 which shows that the value of > 0.05 , these results concluded that there was no significant relationship between the attitude of farmers in the management of environmental sanitation cage with suspected scabies. In accordance with the statement Notoadmodjo (2007) that the attitude of farmers in the management of environmental sanitation skable not yet at the stage respect (valuing) is to invite other people to do or discuss with others on an issue, but the respondent only at the stage responds (responding), provide an answer when asked , a task that is given is an indication of the attitude due to an attempt to answer a question or perform a given task, regardless of the job is right or wrong.

Relationships action in the management of environmental sanitation breeder cage with suspected disease scabies in getting test results statistical p value is 0.014 which shows that the value of < 0.05 , it can be concluded that there is a significant relationship between the actions of farmers in the management of environmental sanitation cage with suspected scabies , According to Martinez et.al (2009), the environmental impact of the farm may be contamination of soil, water and air that could potentially interfere with the health of the animal itself and humans. From the results of research in getting the majority of respondents do not commit acts of environmental sanitation management action skable that 48 of 84 respondents (57.1%) so it can be inferred to have a significant relationship to the respondent with suspected scabies ie 26 respondents (30.95%).

Along expressed Onayemi (2005) one of the factors advance prevalence of scabies was caused by the lack of sanitation. From the research data that measures respondents lack sanitary facilities or means of support such as no manure waste management facilities (19.7%), lack of wastewater management facilities (18.0%) and lack of shelter waste (12.6 %). Rianti research results (2010) also said that there was a significant relationship between hygiene and environmental sanitation with the causes of skin diseases, including scabies. This study is in line with the results of research Faridawati (2013), which examines the relationship between personal hygiene and individual characteristics with complaints of skin disorders in a scavenger (LaskarMandiri) in the village of Sumur Batu subdistrict Bantar Gebang, showed that skin hygiene has a significant connection with complaints of skin disorders , The results of research in the field, found that 14.8% of respondents did not pay attention to the cleanliness of the skin such as not utilizing clean water for bathing.

Kuspriyanto (2013) reported that the prevalence of scabies associated with education gained prevalence of scabies higher in students tsanawiyah than aliyah, the study in boarding schools in Pasuruan, East Java, and The results Raza et al (2009) in Pakistan low education

levels (<10 years) are factors that significantly influence the incidence of scabies. Based on respondents' level of education is a large part of the SD equivalent ie 42 respondents (48.81%). The research Ciftci (2006) and Ratnasari study (2014) showed that a low education level (the highest is only up to primary school) tend to be higher prevalence scabies significantly compared with persons with higher levels of education.

4. Conclusion

There was a significant correlation between the action of farmers in the management of environmental sanitation cage with suspected scabies.

References

- [1] Azizah and Setiyowaty., 2011. Capital Scavenger Relationships Knowledge Level About Personal Hygiene In Genesis Scabies In Toddlers At the final disposal of Semarang. *Midwifery dynamics*. 1: 1-5.
- [2] Baur et al., 2013. The Pattern of Dermatological Disorders Among Patients Attending the Skin O.P.D of a Tertiary Care Hospital in Kolkata, India. *Journal of Dental and Medical Sciences* 3.
- [3] Ciftci IK, Karaca S, Dogru O, Cetinkaya Z, & Kulac K., 2006. Prevalence of pediculosis and scabies in children of preschool nursery Afyon, Turkey. *Korean Journal of Parasitology*, 44, 95-98.
- [4] R.I. Health Department, 2008. *The Indonesia Health Profile*. Jakarta.
- [5] Lombok Barat District Health Office, *District Health Profile 2015 West Lombok*.
- [6] Disperanakbun Lobar, 2015. *Documenting Results Number of Livestock in West Lombok regency*. Section Keswan.
- [7] Effendy, Uchjana.O., 2008. *Dynamics of Communication*. Bandung: PT. Teens Rosdakarya.
- [8] Faridawati, 2013. *Relationship between the Personal Hygiene and Individual Characteristics With Skin Disorders Complaints In Scavenger (LaskarMandiri) in the village of SumurBatusubdistrictBantarGebang*. Thesis UIN SyarifHidayatullah Jakarta.
- [9] Handoko, 2009. *Dermatology and Venereal (V Edition)*.
- [10] Kuspriyanto, 2013. Influence of Environmental Sanitation and Healthy Behavior Students Against Scabies Genesis dipondokPesantrenPasuruan, East Java. *Scientific Journal of UNS.*; 11: 21.
- [11] Ma'rufi I, Keman S and Notobroto HB, 2005. Factors That Contribute to Environmental Sanitation PprevalensiAgainst Scabies Disease Study On Students at boarding Lamongan. *Environmental health journal vol 2 no.1*, 11 -18.
- [12] Martinez and Jose, Patrick Dabert, SuzelleBarirngton, and Colin Burton, 2009. "Livestock Waste Treatment Systems for Environmental Quality, Food Safety and Sustainability." *Science Direct journal Bioresource Technology* 100 (2009) 5527-5536.
- [13] Mubarak and Chayatin, 2009. *Public Health Theory and Applications*. SalembaMedika. Jakarta.
- [14] Murtiastutik, 2009. *Textbook of Sexually Transmitted Infections*. Yogyakarta: Erland.
- [15] Notoatmodjo, 2010. *Methodology for Health Research*. 1st ed. Jakarta: Rineka Reserved.
- [16] Onayemi O., Isezuo SA. & Njoku CH., 2005. Prevalence of different skin conditions in an outpatients' setting in north western Nigeria. *International Journal of ermatology* 44, 7-11.
- [17] Regulation of the Minister of Health No. 416 / Menkes / Per / IX / 1990 concerning requirements and supervision of Air Quality.
- [18] *Rural Development Profile Lelede district of Kediri 2015*
- [19] Ratnasari and Sungkar, 2014. The prevalence of scabies and Associated Factors in Pesantren X, East Jakarta', *Journal of the University of Indonesia*, Vol.2, No.1, pp. 251-256.
- [20] Raza et al., 2009. Risk factors for scabies Among male soldier in Pakistan: a case control study. *Eastern Mediterranean Health Journal* 15.1-6.
- [21] Rianti, E.D.D., Palgunandi, B.U., and Mansyur, 2010. Analysis of Hygiene And Sanitation With Occurrence Causes of Skin Diseases in Sub Asemrowo Surabaya. *Journal of Medical Sciences*. 1 (1): 1-10.
- [22] Soekanto and Soerjono, 2002. *Role Theory*. Jakarta. earth Literacy

Characteristics Of Water Inundation In The Swampland Of Pelabuhan Dalam Village (Ogan Ilir South Sumatera)

Puspitahati ^{1*}, Edward Saleh², Robiyanto H. Susanto², Ngudiantoro²

¹ *Student Doctoral Program of Agricultural Sciences Faculty of Agriculture, Sriwijaya University, South Sumatera*

² *Supervisor of Doctoral Program*

**Email: pusphyt4@yahoo.com*

Abstract

Fluctuations in water level is very closely related to the rain and tidal rivers. Water level fluctuations can change from year to year, so it will change the characteristics of water fluctuation pattern. During the rainy season, water from tidal river resulting inundation occurred in paddy fields. Thus, High and period of inundation water on the swampland is affected by rainfall and tides from the river. In determining the pattern and the planting period must adjust the characteristics of an inundation in the swampland. Therefore, this study purpose is to determine the characteristics of the inundation, a pattern and depth of inundation. The methods were used observation and experiment, and inventory data. Direct observation to the field that was in the rice fields on Village of Pelabuhan Dalam. Microcontroller sensors were used to measure water fluctuations in research location area, analysis was done by using GIS and ETo analysis also graphic tabulation. This study was conducted in the District of Keramasan Pemulutan, Pelabuhan Dalam Village, Ogan Ilir South Sumatera from march to September 2016. Finally, The conclusions that can be drawn were 1)Inundation characteristics in Pelabuhan Dalam was influenced by river tidal from Ogan river, The depth of an inundation of water was influenced topography factor, also by the distance between the land and the water channel of the river, 2)water fluctuation during the morning was tend to be higher than during the afternoon, 3)There are some characteristics of water inundation : ZONE I: Zone which has water depth of -50 cm (50 cm below groundwater level) to 0 cm, ZONE II: Zone which has water depth of 0 cm to 50 cm on the ground, ZONE III: Zone which has water depth of 50 cm to 100 cm on the ground.

Keywords: *inundation, water level fluctuations, swampland, river tidal, rainfall*

1 Introduction

The Fluctuations in water level is very closely related to the rain and tidal rivers (Puspitahati et al, 2013). Erratic rainfall can change the water level fluctuations from year to year, so it will change the characteristics of an inundation. During the rainy season, occurred inundation in paddy fields. Height and long term of inundations on field are affected by rainfall and water level of the river.

In addition to rainfall, water level fluctuations are affected by sea levels rising and tidal rivers. It will affect hidrotopografi and the ability of land drainage (Rahmadi et al, 2010). Fluctuations and periods of high water levels in the soil will affect the type of inundation. Inundation of swampland can be caused by tides, rain puddles or rivers overflow (Noor, 2007). Swampland, especially in Pelabuhan Dalam village has a characteristic that is

influenced by the tide of the river. It is caused by fluctuation of the tidal rivers and rainfall, then the water level in the fields can not be predicted certainty. Therefore, the pattern of swampland management in Ogan Keramasan undeveloped optimally, such as the cropping pattern is still in the form of rice-fallow, the condition of the water level as a constraint, so that farmers are able to grow rice once per year periodically (Saleh et al., 2013). These problems can reduce productivity and cause failure of crops in swampland.

Finally, Successful management of agriculture in swampland is determined by water management (Susanto, 2010) and the water control to optimize land (Ogban, P. I. et al, 2010). Water management of swampland can be done through the adaptation and water management engineering. However, it is not sufficient just by adaptation (Sang Ok, 2012), it is important to determine the characteristics of inundation water in order to predict and to design cropping pattern more than two periodically in a year. High and period of inundation water on the swampland is affected by rainfall and tides from the river, so this study purpose is to determine the characteristics of the inundation, a pattern and depth of inundation.

2. Materials and Methods

This study was conducted in the District of Pemulutan, Pelabuhan Dalam Village, Ogan Ilir, South Sumatra. It was from march to September 2016. The methods of the research were surveys, installation of measuring devices, observations of water levels and rainfall, the analysis of the characteristics of an inundation. To find out the fluctuations in water level and precipitation for 3 months was observed in the fields. Rainfall was measured every day when it was rain. It was plugged piscal boards along 2 m in to the location area to measure the water level. This research also used sensors device (Microcontroller sensors) and pziometer to observe fluctuation the water.

The analyzes of water level fluctuation were done by hydrograph water level fluctuations and chart comparison of the relationship between the rainfall and water level. After that, carried the analysis characteristics of inundation in swampland and did classify the type and characteristics of inundation by looking at the pattern and depth of inundation. Analysis inundation water was according to criteria of swampland based on hidrotopografi which classified in three types.

3. Results and Discussion

The highest rainfall in June 2016 with the thickness of the water was 30 ml on the 26th, the highest rainfall in July 2016 with the thickness of the water was 20 ml on 23th, while the highest rainfall in July 2016 was the thickness 30 ml of water were on 22th and 20th.

Characteristics of water inundation is the behavior of water particularly in swamp land from time to time or from season to season can cause by the early of flooding, stagnant water and the end of the flooding. It can be seen from the length and the depth of water level. Water level fluctuations can change from year to year, so it will change the characteristics of water fluctuation .

The results of measurements of water level in fields. Measurements were made every day using piscall board and sensors from May to July 2016.

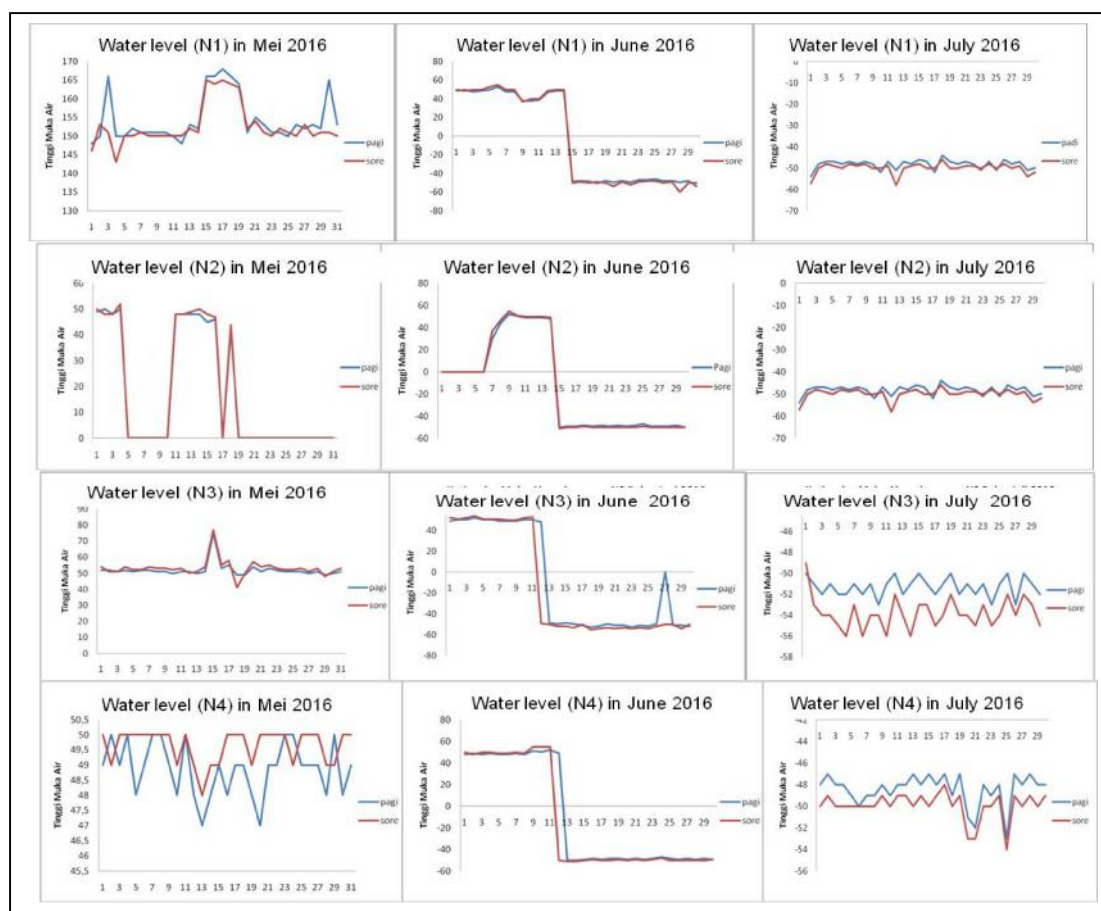

Figure 1. Results of water level (N1,N2,N3,N4) in Mei, June and July 2016

In determining land zones, the estimation based on the average height of stagnant water which was time has longer than others. It was measured with four points zones there were zone N1, N2, N3 and N4. the result of classifications were based on water level height, there are some characteristics :

- 1) ZONE I: Zone which has water depth of -50 cm (50 cm below groundwater level) to 0 cm.
- 2) ZONE II: Zone which has water depth of 0 cm to 50 cm on the ground
- 3) ZONE III: Zone which has water depth of 50 cm to 100 cm on the ground

On land N1 and N2 can be categorized of zone 1 because it was included a bit drier than on land N3 and N4. It was influenced by topography factor. It is because the land N3 and N4 are more inclined to decline and was lower than in land N1 and N2. In addition, the depth of water inundation is influenced also by the distance between the land and the water channel of the river. In the land N3 and N4 were closest to the drains that drain water from the river water.

So that when it was tide, water flowed directly into the channel and into the zone N3 and N4, then entered the zone N1 and N2. And when it subsided, the land N1 and N2 were dry earlier than land N3 and N4.

4. Conclusions

Finally, The conclusions that can be drawn were :

1. Inundation characteristics in Pelabuhan Dalam was influenced by river tidal from Ogan river, The depth of an inundation of water was influenced topography factor, also by the distance between the land and the water channel of the river.
2. water fluctuation during the morning was tend to be higher than during the afternoon.
3. There are some characteristics of water inundation :
 - 1) ZONE I: Zone which has water depth of -50 cm (50 cm below groundwater level) to 0 cm.
 - 2) ZONE II: Zone which has water depth of 0 cm to 50 cm on the ground
 - 3) ZONE III: Zone which has water depth of 50 cm to 100 cm on the ground

References

- [1] Puspitahati, Saleh E., Purnomo, RH. 2013. Water Management Of Swampland As Adaptation Toward The Climate Change In South Sumatera. Prosiding International Seminar on Climate Change.
- [2] Rahmadi, Suryadi, Robiyanto H. Susanto and Bart Schultz. 2010. Effects Of Climate Change And Land Subsidence On Water Management Zoning In Tidal Lowlands Case Study Telang I, South Sumatra
- [3] Noor, M. 2007. Swampyland: Ecology, Utilization and Development. PT Raja Grafindo Persada. Jakarta.
- [4] Saleh, E., C. Irsan dan M.U. Harun. 2013. Evaluation of Planting Pattern on Swamp Land Keramasan Ogan. Research Report. Sriwijaya University. Indralaya.
- [5] Susanto, R.H. 2010. Wetlands Management Strategy for Sustainable Agricultural Development. Books Inauguration Soil Department, Faculty of Agriculture. Sriwijaya University.
- [6] Ogban, P.I., Effiong, G.S., Obi, J.C. dan Ibia, T.O. 2011. Characteristics, Potentials, and Constraints of Wetland Soils for Agricultural Development in Akwa Ibom State, South-Eastern Nigeria. 7(2):80-87

Elements Social Capital in The Vegetable Marketing In Tawangargo Village , Malang Regency, East Java

Sugeng Riyanto¹⁾, Kliwon Hidayat²⁾, Keppi Sukei²⁾

Department of Social Economic Agriculture Faculty of Agriculture Brawijaya University Malang

E-mail : [sukesbyallah@gmail.com](mailto:suksesbyallah@gmail.com)

Abstract

Social capital undoubtedly has a significant role in vegetable marketing. The interrelationship between farmers, trader, and worker create a certain relationship that forms a social capital in vegetable marketing. This study aims to: 1 Find out whom gets involved in the vegetable marketing, 2 Analyze the elements of social capital, and 3 social capital formation process. This study used a qualitative approach. Data analysis technique used in this study is an interactive model. 1. The study found several actors in vegetable marketing activities, they are village-level collector traders, big collector trader, major collectors traders to supermarkets, supermarket suppliers, supplier traders, farmer's buyer trader and workers. Vegetable middlemen community's element of social capital is trust (Traders paid the vegetable after the commodities are sold), social networking (New traders able to enter the market easily only if they come from the same village as the old middleman), and social norms (Trust is also an important social capital, they believe that they will fulfil their duties each other (trader-trader and trader-farmer). The formation process of vegetable middlemen's social capital can be divided into two: 1 Relationship with workers and farmers which has grown up by neighbor and brother relationship. 2 Relationship with the other traders which is grown up by a continuous interaction process.

Keywords : *Social capital, vegetable marketing, farmers, middlemen*

1. Introduction

Agricultural markets are relatively different from other markets because it has characteristics involving the farming community and the trader community that have interrelationship between actors and natural resources. Social capital as a critical success factor of vegetables horticultural marketing system of agricultural market because it has patterns of social interaction in which specific social interaction has an important role in keeping their interaction patterns. Social capital in the marketing of vegetables in Tawangargo village has been maximized to support vegetable marketing activities in line with the Syahyuti's statement (2008) of agricultural markets in form of imperfect competition, agricultural markets need the social capital to smoothen marketing activities of agricultural products.

Social capital developed in vegetable marketing is really attractive since it is full of competition, but in this community, in an effort trafficking vegetables, it still uses elements of community/social capital. From that, this research will be needed in order to know how social capital in a community of traders in the Tawangargo village.

2. Materials and Methods

This study uses a qualitative approach, the process of extracting data to understand the social phenomenon based on thorough research (holistic), formed by the words, and obtained from the natural situation. In the implementation of this qualitative approach, it is

used to observe phenomenon of the social capital dynamics in the vegetable marketing in Tawangargo.

2. Study Findings And Discussions

2.1. Description of Actors Involved in Vegetable Marketing

Vegetables become a strategic commodity in Tawangargo village since some traders begin to sell the commodity out of town. They start selling at local markets such as Batu, Gadang, and Blimbing to further expand the market to Surabaya, agro market, Mojokerto, and Porong. The expansion of the vegetable market is increasingly attracting other people to become traders and it increases in subsequent years. The increasing number and marketing activities are automatically complicating marketing channels. There are several types of traders involved in marketing channels depending on its position in marketing channels. In local terms, the traders are trader collectors in village level, big collector trader, big collector trader for the supermarket merchant.

2.1.1. Small Collector Traders

Collector traders in village level is a trader who does his work by cutting vegetables directly to farmers. Besides cutting, it also slashes the partnership by giving capital to the farmers. Collector trader in village level usually can not directly sell the vegetables to the market because it has no market network. Besides the reason of not owning the network market, collector traders in village level is also unfamiliar with the social situation in the market, so they are afraid to be cheated.

2.1.2. Big Collector Traders

Big Collector Traders are traders from Tawangargo Village which is directly selling vegetables to the vegetable markets around Malang from Porong Market, Mojokerto Market, Agro Market, Lawang Market, Karangploso Market, Lawang Market and Malang Market.

2.1.3. Supermaket Standard Big Collector Traders

Supermarket standard big collector traders is a trader that serves vegetables sold in supermarkets, example of this type of vegetables is peppers, broccoli, Siomak, cucimis, and others. Big collectors in supermarket standards do not directly sell to supermarket but it passes second hand dealers before reaching the supermarket. Second-hand traders are traders who have a cooperative relationship with the supermarket contracts.

2.1.4. Workers (Coolie)

Labor owned by the trader, who has a role to smoothen diverse activities of their vegetables marketing activities. Their workers are distributed in various positions such as duty harvesting in the fields, transporting to the packing house, as the packers, and last is their duty to sell vegetables or participating to sell vegetables in the market. Their workers still have close relationships between them. workers come from relatives, neighbors, and their companions.

2.1.5. Vegetables Farmers

Farmers is a very important partner for their businesses. Farmers have a good relationship with traders in their village. Usually, the trader already has farmers who have a cooperative relationship. Farmers and traders develop cooperation on the basis of a mutually beneficial relationship. Traders need farmers and farmers also need the traders. Farmers feel advantaged by the vegetable traders in their villages to plant vegetables commodity needed by farming traders will be more prosperous for farmers. This is because

the vegetables commodity including commodities that have high economic value and vegetables have a relatively short lifespan of other commodities.

2.2. Social Modal Elements

Social capital has been invested since their ancestors. Mutual cooperation, a sense of community, and maintaining the norms of public life. Social capital is a rule that has been keeping the harmony of society. One of social capital developed in the marketing of vegetables in Tawangargo is trust. Trust is a form of social capital builds based on community relations villages filled with elements of kinship. Sense of family also has an impact on any activity undertaken by all the villagers. In the vegetable marketing business of trust in form of farmers giving kepercayaan on traders in kind penen meraka entrusted to traders to be sold without having paid in advance, and paid after the traders have to sell it in the market. The trader's trust is to provide capital to farmers in exchange for vegetables sold at traders who provide capital.

Social networking is a relationship that makes it possible to bring an economic potential in a particular social system in society. Social networks within the community embodied in the form of network marketing. This network marketing is used to grow their businesses. Vegetable marketing network in Tawangaargo is started from some people conducting trading activities, at first some of these people only trade some types of agricultural products produced from the area. This is in line with the results of this study (Theingi *et al*, 2008), social relationships can foster, develop and require the enactment of norms in a relationship. Social capital does not directly contain or have value for money. Nonetheless, social capital can facilitate the relationship between the perpetrator and tie network through trust.

That harmony is strengthened by norms applicable between them. Trust and social network reinforced with the norms prevailing between them. Trust and social networks are reinforced by prevailing social norms, to social norms will minimize fraudulent activities in vegetables marketing. Social norms in marketing intangibles from traders and farmers. Traders definitely pay vegetables they had bought and farmers will sell vegetable to traders who have provided capital to farmers. Trust is a form of vegetable marketing, especially a belief will not play dirty in doing marketing, both in getting vegetables and selling vegetables.

The description above socialcapitalconsists of 3 elements, they are trust, social norms, and social networks. This is in line with Putnam's statements (1993) that social modal is as amutual trust between society member and society to their leaders. Social capital is defined as social institution involving networks, norms and social trust.

2.3. The Forming Process of Social Capital

Here, it will describe about forming process of social capital in three things: in obtaining wares, manpower, and in selling vegetables. First, the formation process of social capital of farmers and traders, beginning with some traders who sell commodities developed in Tawangargo. The commodity is the onion and garlic. Farmers leave their crops to traders to be sold to the market without having to pay for it at first. Payment of onion and garlic growers harvest is conducted by traders once everything is sold in the market.

Both labors that they manage are labors coming from their closest environment. The nearby neighborhood comes from relatives, neighbors, and their companions. Automatically, that capital social in employment has been built from the outset. With capital's closeness of the relationship, it creates employment to be easily controlled. As Fukuyama (1999) stated that social capital grows and develops from lineage based society group.

These three processes to build process conducted by the traders are a very long journey. Development of this market has two versions. Version of supermarket traders and

traditional market traders. Supermarkets, market development is conducted by delivering to the supermarket merchants. Traders continue to serve the orders although the number of orders is not balanced with the distance to deliver vegetables to the amount of goods ordered. Good service is a social capital that creates the customer trust and it will have effect to order more vegetables to the supermarket standard traders. For vegetables marketing to traders who sell in traditional markets by building trust among them. Mutual trust given between traders and consumers are keeping each other. The trader's obligation is selling vegetable in good quality and the right merchant is getting paid from the sale of vegetables in a timely manner and vice versa with consumers.

Consumers will buy vegetables *by nyaur ngamek* it means the buyer will pay vegetables they have bought in the following days. However, big merchants apply the system only to the old buyer. It is as stated by Thiengi *et al.* (2008) that trust gives influence to the social capital through the increase of profit that may be obtained; minimize risk; add relation chance, motivation and ability. Building trust is a strategy that must be conducted in building individual network structure. Besides, trust and behavior trusted are critical aspect of social capital.

Social capital formed as a result of interdependence between actors involved in marketing activity. Farmers depend on the traders, traders depend on the farmers and traders depend on other traders, as stated by Coleman (1994) that people in poor condition will depend much on the people surroundings.

3. Conclusion

Based on the study result and data analysis conducted, it can be concluded that. Actors involved in vegetable marketing activities in vegetable traders community in Tawangargo Village is farmers, workers, small traders, big traders, supermarket standard merchants.

Social capital elements owned by vegetable trader community in Tawangaargo consist of trust, social network, and social norms. The formation process of social capital in vegetable trader community in Tawangaargo can be divided into two, first is social capital with worker and farmer.

Social capital grown begins from social values they own because the worker comes from neighbor's family and friends since long ago before they start trading. The second type is a social capital relationship with other trader, it is an interaction process that is continuously conducted to make them tied in a social capital bonding.

References

- [1]. Coleman, J.S. 1994. Foundations Of Social Theory. Terjemahan Mutaqien, I Widiowati, S.R dan Purwandari. Dasar-dasar teori sosial Penerbit kanisius, Yogyakarta.
- [2]. Putnam, R.D. 1993. The prosperous community: Sosial capital and public life. The Amercan Prospect. Vol.4
- [3]. Syahyuti. 2008. Peran modal sosial (*social capital*) dalam Pemasaran hasil pertanian. Pusat Analisis Sosial Ekonomi dan Kebijakan Pertanian :Bogor
- [4]. Theingi, S. P. dan Y. Phungphol. 2008. Social capital in Southeast Asian business relationships. Journal of Industrial Marketing Management 37 (2008) 523–530
- [5]. Fukuyama, F. 1999. Social Capital and Civil Society. Institute of Public Policy. George Mason University

Kinetics of Increasing Protein Content on The Sorghum Flour Fermentation

Nur Istianah

*University of Brawijaya
Email: n_istianah@ymail.com*

Abstract

Fermentation of sorghum flour using pure baker yeast, pure *Lactobacillus plantarum* or the mix of them could increase the total protein content of the fermented sorghum flour (mosof). It was caused by conversion of substrate to the protein and also might be caused by the growing of biomass cell. Rate of total protein content was studied by the fermentation at the 37°C of temperature in the varying duration of 24-72 hrs. It was compared to the total cell growth to find the influence of cell growth on the total protein. The mathematical approach was introduced to predict the contribution of cell to the protein content. The results showed that the curve of protein content did not have the same trendline. It indicates that the increase of protein content did not dominated by the growing of cell. The kinetic of protein content near to the kinetic of 2nd order reaction with the equation $\frac{1}{[P]} = -0.0005t + 0.0786$.

Keywords: fermentation, sorghum, kinetics, protein

1. Introduction

Sorghum is a kind of cereal that has great potential to be cultivated and developed commercially because of its wide adaptability, high productivity and more tolerance to marginal conditions (drought, salinity and land sour). Based on ICRISAT (1990), sorghum seeds which contain high carbohydrate were used as a raw material in various industries such as beer, starch, sugar, liquid (syrup), jaggery (a kind of brown sugar), ethanol, etc. On the other hand (use more appropriate word or phrase to introduce the readers to bread), bread is one of the common foods that also becomes a stuff food in Europe. Minimum ingredients of bread are the common wheat flour, water, salt and yeast. Wheat flour is the dominant composition, as the source of gluten. Sorghum is a kind of grain that is free of gluten. Sorghum flour can replace or be combined to wheat flour to get gluten-free product. Sedej et al. reported that crackers made from buckwheat (sorghum) flours can increase supply of gluten-free products on the market and may be regarded as health promoting functional foods, especially for celiac disease patients. In order to improve nutritional content of modified bread, sorghum was treated enzymatically or by fermentation. Hrckova et al⁸ reported that treating soy flour with Flavourzyme protease could release more arginine (22.1%), leucine (10.6%), and phenylalanine (12.9%). This can be adopted for sorghum flour to get better pasting properties.

Fermented sorghum flour has many benefits in the bread products such as enriching protein content as lysine, leucine, isoleucina and methionine content increased², improving texture¹³, mouth-feel, acceptability and shelf-life of bread¹. Conversion of sorghum seeds into flour as food is rarely found. Most of the people use sorghum seeds as animal feed only. In the fermentation, it was predicted that microbial growth affected the protein content. This correlation need a confirmation by the mathematical model. Therefore, it is necessary to find the kinetics of sorghum flour fermentation due to increase total protein.

2. Materials and methods

2.1. Materials

Sorghum grains harvested from Pemalang, Indonesia was used as a raw material for the fermented flour production. It had a median diameter of 0.8 cm and its color is brownish white. In this experiment, dry baker's yeast (Saf-instant produced by PT. Saf Indonusa) and *Lactobacillus plantarum* that was cultured in the Biotechnology Lab, AIT, were used to ferment sorghum flour. Whereas (please consider using other words), the ingredients of the bread are fermented sorghum flour, commercial wheat flour (white swan), water, yeast, salt, sugar, shortening (butter), and skim milk.

2.2. Fermentation

Dry baker's yeast and *L. plantarum* either single or their mixed culture were used to ferment the sorghum flour. It was 10^{10} CFU per mL in the single and 10^7 CFU per mL in the mixed culture. Before fermentation, the black husk was removed from the sorghum grain to clean them from cellulose. Pericarp was still maintained because it covers sorghum starch inside. Then, it was ground and sieved using 60-mesh screen. Pasteurization was conducted to the sorghum flour suspension consisting of sorghum flour, distilled water and yeast extract at 60°C for 30 minutes. In this experiment, total volume of fermentation was 350 mL. Fermentation was operated at 37°C, pH 5.5, 200 rpm of agitation speed under anaerobic condition. These conditions were operated in a bio-reactor type 884101/1 no. 02002/96; product of B.Braun Bio-tech International. The fermentation time was varied between 24 and 72 hrs.

2.3. Crude protein determination

Crude protein was determined by Kjeldahl method using Kjeltac TM model 2300, as described in Foss Analytical manual, AB. The method involved digestion of the sample at 420°C for 1 hr to liberate the organically bound nitrogen in the form of ammonium sulphate. The ammonia in the digest ammonium sulphate was then distilled off into a boric and receiver solution, and then titrated with standard hydrochloric acid. A conversion factor of 6.25 was used to convert total nitrogen to percentage crude protein.

2.4. Microorganism growth: microorganisms growth can be measured in terms of two different parameters: changes in cell mass by turbidity measurements and changes in cell numbers by electronic counting chambers.

3. Results and Discussion

3.1. Cell growth curve

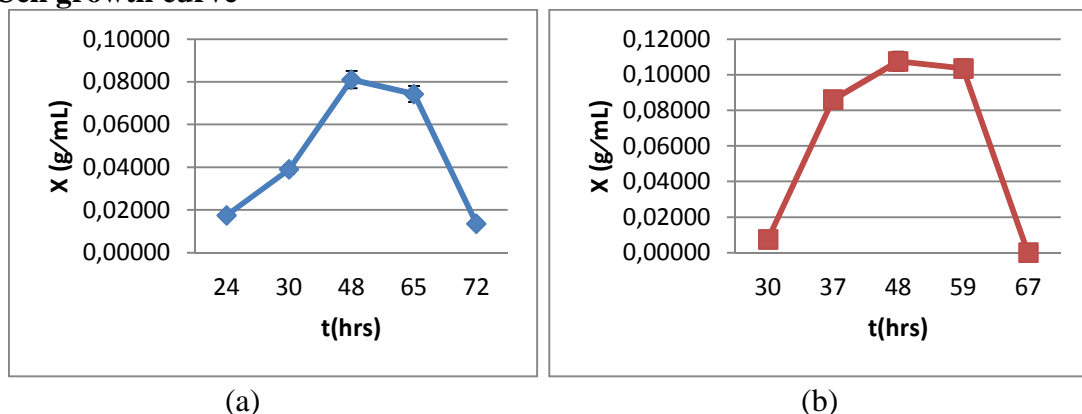

Figure 1. Cell growth curve of fermentation using *L. plantarum*(a) and baker yeast(b)

L.plantarum was used after 4 hrs of incubation and baker yeast after 3 hrs. in order to reach their log phase. Both of total protein content and cell growth was analysed start from 24 hrs fermentation.

3.2. Curve of protein content increasing

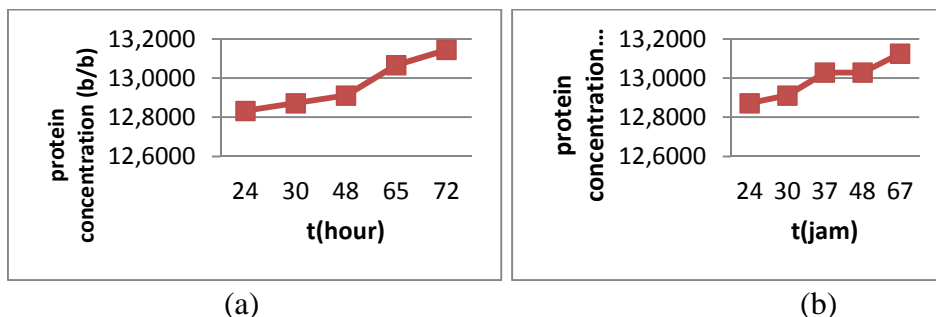
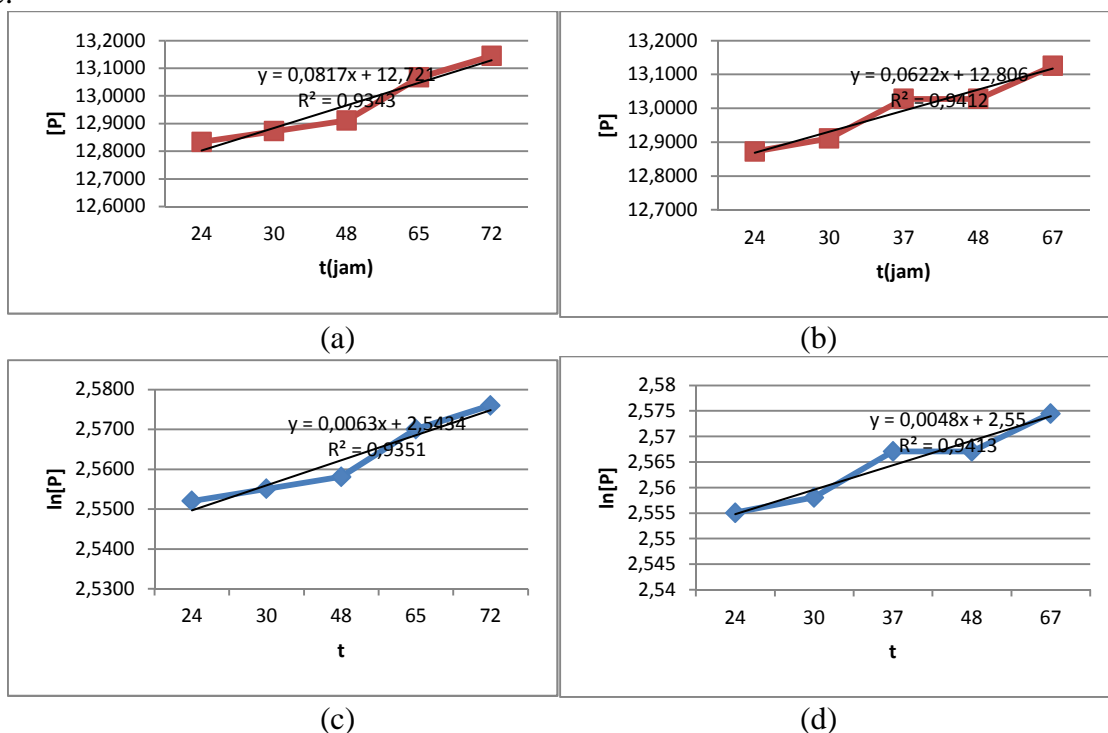

Figure 2. Total protein content of Mosof using *L.plantarum*(a) and Baker yeast (b)

Figure 1 and Figure.2. show that the increasing of total protein content (Figure 2.) has no same gradient and order of equations with the cell growth curve. Both are in the different trendline, non-linear correlation. Therefore, the Monod Equation are not suitable to determine the kinetics of total protein content increase. It means, protein is not the main product of fermentation by *L.plantarum* and Baker yeast.

Another approachment was used to find the kinetics of total protein content increase. General kinetic was introduced to find the fit order and the equation of protein production. It was initiated by the 0-order. The fit model was evaluated by the highest root square (R^2) value.



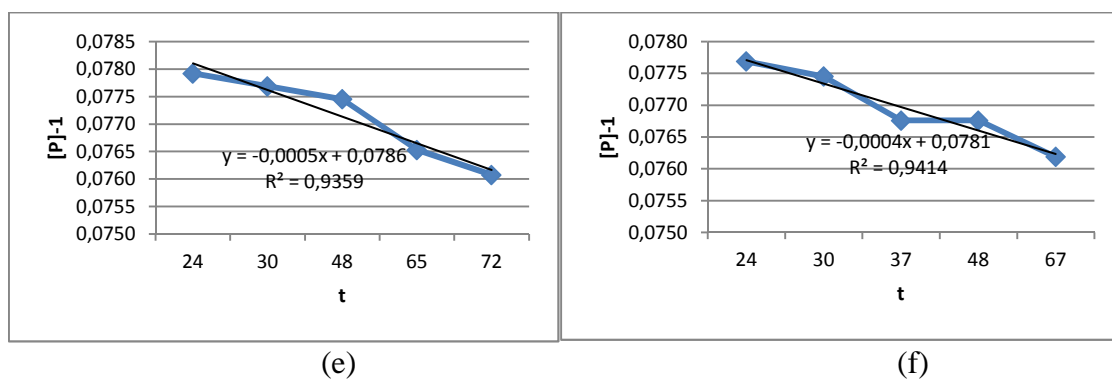

Figure 3. Protein content curve, 0-order (a,b), 1st order (c,d), 2nd order(e,f)

Table 1. The R² value of total protein equations

Orde	Nilai R	
	L.plantarum	Baker yeast
0	0.9343	0.9412
1	0.9351	0.9413
2	0.9359	0.9414

4. Conclusion

Total protein content was not dominated by the cell growth of sorghum flour fermentation. It has the 2nd order reaction in the equation of $\frac{1}{[P]} = -0.0005t + 0.0786$.

References

- [1] Correia, Isabel. (2010). "Screening of lactic acid bacteria potentially useful for sorghum fermentation". *Journal of Cereal Science* 52, 9-15.
- [2] De Vries, Maaïke C.et.al. (2006). "Lactobacillus plantarum survival, functional and potential probiotic properties in the human intestinal tract". *International Dairy Journal*: 6, 1018-1028.
- [3] Earp, C. F. (2004). "Microscopy of pericarp development in the caryopsis of Sorghum bicolor(L.) Moench". *Journal of Cereal Science* 39: 21-27.
- [4] Elkhalfifa, AbdElmoneimO.et.al.(2005). "Effect of fermentation on the functional properties of sorghum flour". *Food Chemistry*(92):1-5.
- [5] Hr ková M., Monika rus áková and Jaroslav zemanovi . Enzymatic Hydrolysis of Defatted Soy Flour by Three Different Proteases and their Effect on the Functional Properties of Resulting Protein Hydrolysates. *Czech J. Food Sci.*2002; 20 (1):7-14.
- [6] IvanaSedej, Marijana Saka, Anamarija Mandi, Aleksandra Mi, Mladenka Pestori, Olivera Simurina, and Jasna Canadanovi Brunet. Quality assessment of gluten-free crackers based on buckwheat flour. *Food Science and Technology*. 2011; 44:694-699.
- [7] M.P. Sirappa. Sorghum Development Prospects in Indonesia as An Alternative for Commodities Food, Feed, and Industry. *Agriculture Research and Development*. 2003; 22 (4).
- [8] Mustafa, Arwa. (2009). "Interaction effects of fermentation time and added asparagine and glycine on acrylamide content in yeast-leavened bread". *Food Chemistry* 112, 767-774.
- [9] Onyango, Calvin.et.al. (2010). "Rheological and baking characteristics of batter and bread prepared from pregelatinised cassava starch and sorghum and modified using microbial transglutaminase". *Journal of Food Engineering*(97):465-470.
- [10] _____.(2011). "Modification of gluten-free sorghum batter and bread using maize, potato, cassava or rice starch". *Food Science and Technology*(44):681-686.
- [11] Ray, Bibek. (2004). "Fundamental Food Microbiology, 3th edition". New York: CRC Press.
- [12] Procopio, Susanne. (2013). "Significant amino acids in aroma compound profiling during yeast fermentation analyzed by PLS regression". *Food Science and Technology* 51: 423-432.

Genes Action in Quantitative Traits of Rice The Result of Crosses Between Ipb 4s Varieties With Red Rice Promising Lines

Baiq Ernawati^{1*}, I Gusti Putu Muliarta Aryana², Anak Agung Ketut Sudharmawan³

1 (Magister Programme of Dry Land Management Resource, Mataram University, NTB – Indonesia)

2 (Lecture In Agriculture Faculty, Mataram University, NTB – Indonesia)

3 (Lecture In Agriculture Faculty, Mataram University, NTB – Indonesia)

*Email : baiqernawati.08@gmail.com/baiqerna_imud@ymail.com

Abstract

Red rice is one of the germplasm that has not been utilized as a source of genetic diversity in breeding programs. This study aimed to determine the role of genes of quantitative traits of crossbreeding progenies between the rice variety “IPB-4S” and a promising red rice line, by conducting a field experiment at experimental station of the Faculty of Agriculture, University of Mataram, located in NyurLembang Village of Narmada District of West Lombok regency. The experiment was designed using Randomized Complete Block Design (RCBD) testing 4 treatments of rice genotypes with 3 replications. The genotypes tested were the parents (G3 and IPB 4S), F1 (G3 / IPB 4S) and F1 (IPB 4S / G3). The parameters measured were days to flowering, plant height, number of productive tiller, number of non-productive tillers, panicle length, number of filled grains, number of unfilled grains, weight of 100 grains, and grain weight per clump. The results indicated that the roles of the genes controlling the nine parameters measured on the crossbreeding progenies between IPB-4S and a promising line of red rice varied between parameters, i.e. it was additive on the parameters plant height, number of productive tillers, number of unfilled grains, and grain weight per clump; it was partial dominant on the parameters days-to-flowering, panicle length, and number of filled grains; and it was dominant on the parameters weight of 100 grains; and it was over dominant on the parameter number of non-productive tillers.

Keywords : *Red rice, genetic parameter, gene action, IPB-4S variety*

1. Introduction

Rice is the staple food consumed by many people in the world, especially in Asia. Although generally white rice consumed, there are also varieties of rice that have color pigments such as red rice, brown rice and black rice. Red rice (*Oryza sativa* L.) is a type of rice that have the coloured. The red colour is caused by anthocyanin pigments which found on the outer layer.

Rice is one of the brown rice germplasm untapped as a source of genetic diversity in breeding programs. Limited development area is endemic in the highlands as upland rice in the old as well as the existence increasingly rare (endangered) due to the planting of the types of new high yielding varieties of rice (1).

Until now estimated to be around 85 per cent of rice areas have been planted with improved varieties. With the increasingly widespread planting of high yielding varieties will urge local varieties, resulting in the shifting of even the extinction of a number of local varieties that have specific adaptations to certain conditions, as it is known as genetic erosion. To overcome in order to avoid sustained genetic erosion, need to rice germplasm collection (2).

Elders with high genetic variation is a very important breeding material in the

assembly of high-yielding varieties. IPB 4S variety is high yielding varieties of rice that has a new type of white colour with the number of seeds and saplings lot less. G3 promising lines have red rice, panicle number less but have many the number of chicks(3). Elders who have variations / high genetic diversity will provide great opportunities to generate cross combinations appropriate to the combined properties of good.

Estimation of the type of gene acts as indispensable as a basis for improvement of efficiency of a breeding program, as a follow-gen describe genes work in showing the morphological characters of plants and can be used in the method of selection purposes. Therefore, information on the follow-gene is very important to know. In this regard, it is necessary to do research on " genes action in quantitative traits of rice the result of crosses between IPB 4S varieties with red rice promising lines”

2. Materials and Methods

These experiments using an experimental method with Randomized Complete Block Design (RCBD)) testing 4 treatments of rice genotypes with 3 replications. This experiment was conducted at experimental field, Faculty of Agriculture, University of Mataram, NyurLembang Village of Narmada District of West Lombok regency. Materials used are two parents (G3 and IPB 4S) F1 (G3 / 4S IPB) and F1 (IPB 4S / G3). Parameters measured were days to flowering, plant height, number of productive tiller, the number of non-productive tillers, panicle length, number of grain contains, the number of empty grain, 100 grain weight and grain weight per clump. The role of genes calculated using the potential ratio according to Petr and Frey (4) is $hp = \frac{mF1 - mMP}{mHP - mLP}$

3. Results And Discussion

Results and discussion presented by displaying the results of the analysis are then discussion for each parameter was observed, are presented as follows:

To see the value of gen action on quantitative characters of genotype G3, IPB 4S, F1 (G3 / 4S IPB) and F1 (IPB 4S / G3) from the result of crosses between white rice with brown rice paddy can be seen in Table 1.

Table 1. Values Gen action Some Quantitative Characters On Genotype G3, IPB 4S, F1 (G3 / 4S IPB) and F1 (IPB 4S / G3)

No	Characters	Hp		Criteria	
		F1 (G3/IPB 4S)	F1 (IPB 4S/G3)	F1 (G3/IPB 4S)	F1 (IPB 4S/G3)
1	Plant age	0.72	0.43	Dominant majority	Dominant majority
2	Plant height	0.2	0.07	Aditive	Aditive
3	Total number of productive tillers / hill	0.24	1.04	Aditive	Dominant
4	Total number of non productive tillers / hill	2.53	2.6	Over dominant	Over dominan
5	Panicle length	0.27	-0.12	Dominant majority	Aditive
6	Number of filled grains	0.74	-1.05	Dominant majority	Dominant
7	Number of unfilled grains	0.23	0.06	Aditive	Aditive
8	Weight 100 grains	0.78	-1.14	Dominant	Dominant
9	Grain weight per panicle	0.17	-0.38	Aditive	Dominant majority

calculations to determine the nature of the additive and epistasis between dominant genes controlling traits. Acts of different genes will make the segregation of different genes (7).

Acts of genes that control traits in rice varieties of crosses IPB 4S with red rice paddy promising lines in Table 1 shows the value that varies. Of the nine parameters were observed in the study of genes is additive, dominant majority, dominant and over-dominant. For five quantitative trait observed, additive and dominant genes play a role in the appearance of properties partially observed both in F1 and the resiprok.

Additive gene is more important than the dominant gene in four parameters observed indicated by the nature of plant height, number of productive tiller, the amount of grain hollow and weight per clump with a value of respectively 0.2, 0:24, 0:23 and 0:17 in the F1 (G3 / IPB 4S) while the dominant gene acts partly indicated by the parameter date of flowering, panicle length and the number of grains contain. In his research on soy, Suprpto et al. (8) shows the value ratio of 0.71 which explains that the dominant genes that control plant height trait is dominant genes partly positive. Dominant genes are more important than additive gene acts that appear on the parameters of a weight of 100 grains with a value of 0.78, while the follow-gene appeared dominant over the nature of the number of non productive tillers showed with 2:54. Meanwhile there are some differences in the criteria in F1 resiprok (IPB 4S / G3) on several parameters: the number of productive tillers and number of grains contain genes that show dominant, panicle length showed additive and dominant genes partly on the weight of grain per clump with a value of -0.38. Ratio potential of -0.38 explained that the dominant gene that controls most of the serious nature of grain per clump is partially dominant gene negative. In his research on sweet corn, Sujiprihati et al (9) also find zero value on the genetic variance and heritability in the broad sense of the nature and corncob cob diameter. This is in accordance with the grouping of the potential value ratio according to Petr and Frey (1966), namely $hp = 0 - <0:25$ acts additive gene, $hp = 0:25 - <0.75$ acts as a dominant gene in part, $hp = 0.75 - <1:25$ dominant and $hp = 1:25$ over dominant.

Knowledge of the gene acts very concerned with determining selection methods on the material being handled (10). According to Basuki (11), when the additive gene is more important than the act of the dominant genes controlling a trait, the more effective mass selection to do at the material. Conversely, if the dominant gene is more important than the act of additive genes controlling a trait, it should be towards the formation of hybrid varieties more quickly.

4. Conclusion

Limited based on the results of this study, it can be concluded that there is a gene actions which varies the nature of the additive, dominant majority, dominant, over-dominant and for some properties such as the number of productive tillers, number of grains contain and the weight of grain per clump should use IPB 4S as male gametes and G3 at panicle length parameter.

Acknowledgement

Thanks to Indonesia Endowment Fund for Education (LPDP), which has funded the research, and the second supervisor who constantly provide feedback and constructive suggestions to enhance the writing of this paper.

References

- [1] Muliarta, N. Kantun, Kisman, Sanisah, Soemenaboedhy. 2004. *Penampilan fenotipe dan beberapa*

parameter genetik 16 genotipe padi beras merah. Agroteksos 14 (3) : 162-167.

- [2] Silitonga, T. B., M. Warson., Indarjo., L. Choliso. 1988. *Variabilitas dan Derajat Kemiripan Sifat-sifat Agronomis Genotip-Genotip Padi*. 25-36 h. Seminar Hasil Penelitian Tanaman Pangan. Balittan Bogor.
- [3] Muliarta, I.G.P., A.A. Sudharmawan, 2014. *Perakitan Varietas Padi Gogo Rancah Beras Merah Fungsional Tipe baru Potensi Hasil (>7 ton/ha) Serta Berumur Genjah (<110 hari)*. Proposal Penelitian Strategis Nasional. Universitas Mataram.
- [4] Petr F.C. and K.J. Frey. 1966. *Genotype Correlation, dominance and heritability of quantitative characters in oats*. Crop. Sci. 6 : 259-262.
- [5] Allard, R.W. 1960. *Principles Of Plant Breeding*. John Wiley and Sons, Inc. New York. 485p.
- [6] Crowder, L.V. 1981. *Genetika Tumbuhan* (terjemahan oleh L. Kusdiarti dan Soetarso). Gadjah Mada University Press. Yogyakarta.
- [7] Singh, R.K., B.D. Chaudary. 1979. *Biometrical methods in quantitative genetic analysis*, Kalyani Publishers. New Delhi. 304 p.
- [8] Suprpto, Narimah Md. Kairudin. 2007. *Variasi Genetik, Heritabilitas, Tindak Gen dan Kemajuan Genetik Kedelai (Glycine max Merrill) Pada Ultisol*. Jurnal Ilmu-ilmu Pertanian Indonesia. Volume 9 No.2, 183-190p.
- [9] Sujiprihati, S. M. Syukur, R.Yunianti. 2005. *Pendugaan Ragam Genetik dan Heritabilitas Beberapa Karakter Vegetatif dan Hasil Jagung Manis*. J. Agrotropika 10(2) : 75-78.
- [10] Salazar, F.S., s. Panday., L.Naro., J.C. Perez., H. Ceballos., S.N. Parentoni and A.F.C.B. Filho. 1997. *Diallel Analysis of acid Soil Tolerant t and in Tolerant Tropical Maize Populations*. Crop Sci. 37: 1452-1462.
- [11] Basuki, N. 1995. *Pendugaan Tindak Gen*. 48 h. Diktat Kuliah. Fakultas Pertanian. Universitas Brawijaya. Malang.

Behavior of Rice Market in the Lampung Province

Irmayani Noer^{1*}, Bina Unteawati²

¹ *Agribusiness Study Program, Economic and Agribusiness Department, State Polytechnic of Lampung Jl. Soekarno—Hatta Rajabasa Bandar Lampung*
Email: fathianoer@yahoo.com

Abstract

The purpose of the study is to analyze the behavior of the rice market in the context of the availability of rice (stock / buffer) for food security in the province of Lampung to approach the market supply of rice planting area of rice and rice productivity . The virtue of the research is on analysis of market availability of rice from the rice planting area and indicate the availability of rice paddy productivity to meet the food needs and ensure that you meet the food needs of the community. The study took a sample of respondents from various parties , namely agricultural producers , marketing actors in the market rate of the village, district , and county / city . Sampling was done intentionally (purposive) and proportionately on the basis of the number of actors the production and marketing of rice from the village level up to the wholesalers . The method will be used to formulate the rice market supply function is the equation of the function of rice planting area, where the planting area is a function of the price of rice and corn prices and productivity function approach, where productivity is a function of the price of rice and grain prices. Results indicate that the rice price increase factors and competitors' products (maize) in the previous year will increase the rice planting area . Similarly, if there is an increase in rice prices in the previous year will increase the productivity of rice. While the rise in input prices of rice and a dummy crisis will reduce the productivity of rice .

Keywords : *market supply of rice , food security*

1. Introduction

The food crisis began to be felt in 2007 because of the population growth rate remains high every year, while on the other side of land available for agricultural activities is limited, or the rate of growth is getting smaller, or even in absolute terms tend to be more narrow (Afrianto, 2010). The World Health Organization estimates that Indonesia is one of the countries threatened by the food crisis in the next few years. The population of Indonesia who have touched the figure of 220 million people make this prediction becomes more pronounced (Arifin, 2001).

The vitality of the agricultural sector is currently experiencing degradation, characterized by decreased production of some agricultural commodities, especially food commodities (Noer, 2010). This production decline resulting in decreased ability of the state to provide food that is characterized by an imbalance between the production of foodstuffs with population growth.

When viewed from the consumption aspect, embodiments food security has run into difficulty because the majority of the Indonesian people for this meeting the food as a source of carbohydrates, such as rice. With the level of rice consumption at 130 kg / cap / yr to make Indonesia as the highest consumers of rice in the world, far surpassing Japan (45 kg), Malaysia (80 kg), and Thailand (90 kg). Indonesia's population totaled 212 million need rice for domestic and industrial use more than 30 million tons per year (Siswono et al., In Afrianto, 2010).

Lampung Province as one of the producers of rice in Indonesia has a responsibility to fulfill the need for consumption of rice as a staple food community, not only for local needs but also as a buffer of national rice. Therefore, in addition to rice production conditions need to be investigated how factors such as the price of rice, the area under rice harvest, the average production of rice, maize prices dam gaba prices have an impact on the availability of rice to support food security in the province of Lampung.

This research aims to: (1) analyze the behavior of the rice market in the context of the availability of rice (stock / buffer) for food security in the province of Lampung to approach the market supply of rice and rice market integration, and (2) analyze the effects of the harvested area, productivity, grain prices, the price of rice, and corn prices on the market supply of rice in the province of Lampung.

2. Materials and Methods

Rice supply model using a two-stage approach is by predicting the function of rice planting areas, where the planting area is a function of the price of rice and maize prices second stage using a productivity function approach, where productivity is a function of the price of rice and grain prices. Forms used function is Cobb - Douglas (double logarithm) with the following equation

1. Approach the function of planted area, mathematically as follows

$$\ln A_{Pt} = \alpha_0 + \alpha_1 \ln P_{Bt-1} + \alpha_2 \ln P_{jt-1} + \epsilon_{1t} \dots\dots\dots (1)$$

Where:

- A_{Pt} : is rice planting areas all i in year t
- P_{Bt-1} : is the price of rice to - i in year t - 1
- P_{Jt-1} : is the price of corn to - j in year t - 1

2. Approach productivity functions as follows :

$$\ln Y_{Pt} = \beta_0 + \beta_1 \ln P_{Bt-1} + \beta_2 \ln P_{xt} + \beta_3 D_t + \epsilon_{2t} \dots\dots\dots (2)$$

Where :

- Y_{Pt} : Productivity of paddy to - i in year t
- P_{Bt-1} : is the price of rice to - i in year t - 1
- P_{Xt} : is the input price of rice (paddy) in year t

The rice market is an indirect approach, as was done in the research Fitriani, et al., (2008) where the amount of production / supply (Q / S) of agricultural products is the multiplication of the planting area (A_{Pt}) and productivity (Y_{Pt})

$$Q_t = A_{Pt} \times Y_{Pt} \dots\dots\dots (3)$$

Where :

- Q_{Pt} : Total supply of rice in year t
- A_{Pt} : rice planting area all i in year t
- Y_{Pt} : Productivity of paddy to - i in year t

Aside from the level of rice production is generated, the availability of rice (rice stocks)

for the structure of people's food needs and the integration of the rice market. Furthermore, based on the results of a study conducted by researchers the structure and integration of the market showed that the market at the farm level and the retail level in Lampung province has a strong level of integration (Noer, 2010).

3. Results and Discussion

3.1 Factors Affecting Rice deals with Rice Planting Area Function Approach

Estimation models of rice planting area in a model allegations:

$$\ln Y_{it} = 11059 + 0,151 \text{ PBT-1} + 0.100 \ln \text{PJT-1} + e_{it}$$

The regression coefficient 0.151 indicates that any price increases of rice the previous year by 1% ceteris paribus, the rice planting area will increase by 0, 151 hectares. The regression coefficient of 0.100 indicates that any price increases of corn the previous year by 1% ceteris paribus would increase paddy planting area of 0,100 Ha. The rise in the price of rice and rice products of competitors in the previous year ceteris paribus will increase the planting area of rice so that rice offers increased (in terms of production).

The result indicate that at the time of the decision making process whether to plant crops or not, the main factors or variables considered by farmers of rice price is just one year earlier.

3.2 Factors Affecting the Production and Special Rice with Rice Productivity Function Approach

Estimation models of rice productivity in a model allegations :

$$\ln Y_{it} = 2436 + 0007 \ln \text{PBT} - 1 - 0140 \ln \text{PXT} - 0:34 \text{ Dt} + e_{it}$$

Statistical value of $F = 58.143$ and significant at 10%, which means that the model is already well defined and appropriate. These results indicate that at the time of the decision making process whether to plant crops or not, or the main variable factors considered by the farmers is the price of rice, corn and rice input prices one year earlier.

Rice productivity change response to changes in the price of rice of the previous year is shown by the amount of estimated parameters (regression coefficient) is equal to 0.007. The magnitude of this value indicates that any changes in the price of rice of the previous year by one percent, ceteris paribus, there will be changes in the productivity of rice amounting to 0.007%. That is, if the price of rice a year earlier rose by 1% ceteris paribus, the productivity of rice in the current year will have an addition of 0.007% of the productivity of the previous year, and vice versa if the price of rice a year earlier fell by 1% ceteris paribus, the productivity of rice at current year will be decreased by 0.007%.

4. Conclusion

Based on the results of research conducted, the conclusion can be drawn as follows.

1. Factors that affect the production and supply of rice in the province of Lampung good approach paddy planting areas function well with productivity function approach shows that only the prices of rice, corn prices and input prices of the previous year, which have a significant impact.
2. Response changes in the production and supply of rice for food security in the province of Lampung is influenced by the price of rice, corn prices and input prices one year earlier.

References

- [1] Bustanul, A. 2001. *Spektrum Kebijakan Pertanian Indonesia*. Erlangga. Jakarta.
- [2] Afrianto, D. 2010. *Analisis Pengaruh Stok Beras, Luas Panen, Rata-Rata Produksi, Harga Beras, dan Jumlah Konsumsi Beras terhadap Ketahanan Pangan di Jawa Tengah*. Universitas Diponegoro. Semarang.
- [3] Irmayani, N. 2010. *Kajian Produksi dan Penawaran Beras di Provinsi Lampung*. *Jurnal Penelitian Pertanian Terapan Edisi Khusus Oktober 2010*. Politeknik Negeri Lampung. Bandar Lampung.
- [4] Fitriani, A., Irmayani, N. 2008. *Respon Penawaran Ekspor Kopi di Provinsi Lampung*. *Jurnal Manajemen Akuntansi dan Bisnis FE Univ Widyagama*. Malang Volume 6 Januari 2008. Halaman 165—169.

Optode Urease Biosensor and Their Application for the Determination of Hg (II) in Aqueous Solution

Dhony Hermanto^{1*}, Mudasir², Dwi Siswanta², Bambang Kuswandi³

¹Department of Chemistry, Faculty of MIPA – University of Mataram, West Nusa Tenggara 83125, Indonesia

²Department of Chemistry, Faculty of MIPA – University of Gadjah Mada, Yogyakarta 55281, Indonesia

³Chemo and BioSensor Research Group, School of Pharmacy – University of Jember, Jember 68121, Indonesia

* Email: dhony.hermanto@gmail.com

Abstract

Optode Biosensor was designed for determination of Hg(II) by using inhibition of enzymatic activity of urease integrated with bromothymol blue (BTB) immobilized into alginate–chitosan polyelectrolyte membrane.. Chemically synthesised alginate–chitosan was used as supports for urease–BTB immobilisation. The urease–BTB was immobilised onto polymer by using sol-gel technique. Measurements were performed by color changeable optode monitoring on the inhibition of the enzyme activity. Experimental factors that affect biosensor response were investigated and optimized, such as temperature and pH. The analytical characteristics of the biosensor prepared toward Hg(II) are described. The result of experiment indicates that the response of the optode biosensor prepared in good agreement with with the reference method in determination of Hg(II).

Key words: *optode biosensor, urease, BTB, Hg(II)*

1 Introduction

An increasing concentration of mercury as one of the heavy metals in the environment is a serious problem for human and animal health protection and production of foodstuffs in many countries around the world [1,2,3]. That is why easy and quick detection of heavy metals at very low concentrations levels in environmental. The optode biosensors have superior properties over the other existing measurement systems because they can provide rapid, simple and low-cost on-field determination number of metal ion. In addition, biosensor technology is a powerful alternative to conventional analytical techniques, combining the specificity and sensitivity of biological systems in small devices.

Enzyme inhibition methods based on optode biosensors are commonly used for metal ion determination, since these can be based on the use of a wide range of enzymes that are specifically inhibited by low concentrations of certain metal ions [4]. Immobilisation of enzyme into suitable support material is one of the most important steps in designing of a biosensor, since this step plays an important role in the overall performance. In last decade, various matrixes used as enzyme immobilisation supports. Polyelectrolyte complexes (PEC) used as membrane for enzyme immobilisation, it has been reported that immobilized enzymes retain higher activities than native enzymes and were stable [5]. Alginate as polyanion and chitosan as polycation when dissolved in appropriate condition can interact each other through carboxyl group of alginate and amino group of chitosan [6] and its ionic interactions are the main interactions inside the network. PEC formed is expected to provide better application due to their unique structure and properties.

In this work, a simple and fast immobilisation method is described based on chemically synthesised alginate-chitosan membrane. The optimised condition for urease immobilisation was defined and the effects of pH and temperature on the optode biosensor response and the stability of the biosensor are studied as well as its analytical characteristics.

2 Materials and Methods

The urease used for preparing the biosensor was E.C. 3.5.1.5. from jack beans, Type III, U1500, 272 $\mu\text{g/g}$ was stored at 4⁰C, sodium alginate was 300–400 cp from brown algae, and chitosan was 95% deacetylated from crab shell were purchased from Sigma (St. Lois, USA). Hydrochloride acid (37%), glacial acetic acid (98%), sodium hydroxide, potassium dihydrogenphosphate (KH_2PO_4) and sodium tetraborate ($\text{NaB}_4\text{O}_7 \cdot 10\text{H}_2\text{O}$), brom Thymol blue were received from Merck (Germany). Stock solution of urea (1000 $\mu\text{g/mL}$) was prepared in aqueous solution. $\text{Hg}(\text{NO}_3)_2$, AgNO_3 , $\text{Cd}(\text{Cl})_2$, CuSO_4 , $\text{Pb}(\text{NO}_3)_2$ solutions were prepared by appropriate dilution. All other reagents were analytical grade and were used without further purification. Solutions were prepared with deionised water. All the reflectance measurements have been conducted by using an optical fibre spectroscopy (spectrophotometer model USB 2000, Ocean Optic). A pH meter model IM-20E (TOA Electronic Ltd.) was employed for all pH measurements.

2.1 Preparation of membrane

Membrane was prepared by mixing two polymer solution, chitosan and alginate solutions. Chitosan solution was obtained from 1 g of chitosan was dispersed into 25 ml distilled water and then dissolved by adding 5 ml of glacial acetic acid with stirring using a magnetic stirrer to form a homogeneous mixture. Furthermore, alginate solution was prepared by dissolving 1 g of alginate in 25 ml of distilled water, then the solution was allowed one night. The formed polymer was complex alginate-chitosan sol-gel.

2.2 Immobilisation procedure

PEC membrane alginate-chitosan is used as the supporting material (solid support) for enzyme immobilisation. Immobilisation of urease-BTB on sol-gel glasses has been performed in three steps: (i) preparation of sol solution from mixer both polymer of 50 ml alginate-chitosan, 2 ml of 32% HCl, and then added a solution of NaOH 10% (w/v) to obtain a pH = 5.28. Then, the mixture was stirred until homogenous. (ii) immobilisation of urease-BTB. Here, 3 ml sol, 1 ml phosphate buffer (pH 6.5) and 3 ml urease in 10 drops BTB was stirred for ± 4 hours in room temperature. Afterwards, the sol-gel was transferred to the glass mould with 1 mm dept in order to produce glass block of sol-gel. (iii) ageing process. Then the glass block was stored at 4⁰C for 24 hours for ageing process.

3 Result and Discussion

Fig.1 Shows the spectral of pH indicator (BTB) toward unreacted (a) and reacted biosensor (b). The optimum wavelength conducted to determine the best operational wavelength biosensors, determined by measuring the difference in signal intensity before and after reacted with Hg(II). The signal intensity change when the pH increase in presence of ammonium which is a product of hydrolysis of urea by urease. It is sensed by the BTB indicator, the color change from yellow to green leading to a decrease in the reflected signal intensity (at 580,15 nm). This aspect is particularly important, since the pH working range of pH indicator fits very well with pH changes associated to the enzyme-substrate based reaction. On the other hand, the plain shape of the pH indicator allowed easy access for analyte, which in turn, resulted a high sensitivity of indicator to the net of the pH change. Furthermore, the matrix effects on the pH indicators has been minimized by using buffer as carrier in order to maintain the stability of sensor response to the change of the pH that only correlated to the Hg(II) and not to other parameters (physical and chemical factors) which might change the pH [7].

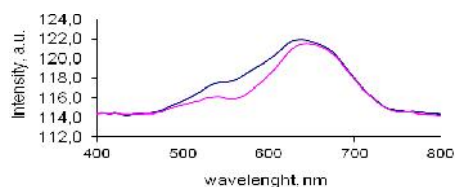

Figure 1. Spectra of the pH indicator (a) before interaction and (b) after interaction biosensor

Table 1. Optimization of experimental parameters

Parameter	Range	Optimum
wavelength (nm)	400–800	580,15
pH	5–8	6
Substrate/Urea (mM)	10–100	75
Flow Rate (mL/min)	10	10
Inhibition Time (min)	4–8	7
Temperature (°C)	25–35	25

By applying the optimised parameters above (Table 1), the dynamic response to Hg(II) was monitored as change in the reflected signal intensity at 580,15 nm, when the optode biosensor was performed by flowing buffer solution, substrates, inhibitors and reactivator alternately with variations of metal concentration (inhibitor) (Fig. 2). Response curve obtained for different concentration of Hg(II) shows a linier curve in the concentration range 10–500 ppb (Fig. 3), with the correlation coefficient (r) is 0.9778 (each point was the average of three injections). As can be seen from Fig. 3, there is a linear correlation between absorbance of the biosensor and concentration of Hg(II) for the interval range of 10 – 500 ppb of Hg(II), with a regression equation of $\%I = 42,424 [Hg(II)] - 35,939$. The detection limit is determined by using analyte concentration when Hg(II) inhibit enzyme for 10%. It was chosen because it assumes that at intensity is 10%, differences before and after inhibition can be observed with 90% confidence level, $I_{10\%} = 12.1$ ppb for Hg(II). The obtained repeatability of the biosensors (coefficient of variation, $Cv = 0.86\%$) is no significant different ($<5\%$), so it can be concluded that obtained data has high precision.

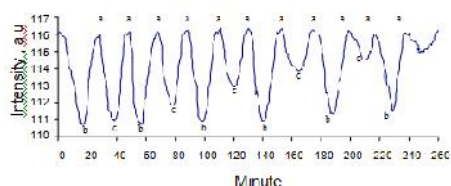

Figure 2. Average response curve of inhibited Hg(II) urease biosensor with variation of concentration and is reactivated by EDTA (a) Substrate; (b) Heavy metal (c) Reactivation.

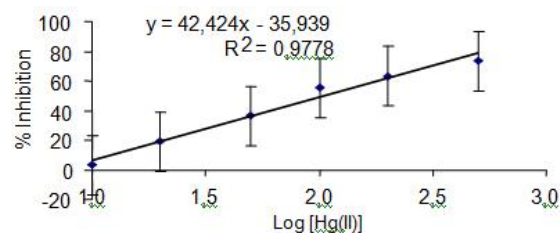

Figure 3. The calibration plot of Hg(II) inhibition vs Log Hg(II) concentration

Fig. 4 shows that the obtained relative value of inhibition was very small ($<5\%$), indicating that ions Pb (II), Cu (II), Cd (II) and Ag (I) were not significant interference. However, the Ag (I) have a relatively large value compared with other ions, this is because Ag (I) at high concentrations will affect the inhibition enzyme activity by metals [8]. To evaluate the ability of the optode biosensor prepared to carry out the analysis of aquatic samples. The standard addition method was used and sample spiking with different amount of Hg(II) were analysed, as described above. Since, the result shown in Table 2 was in good agreement with reference method using atomic absorption spectrometry (AAS).

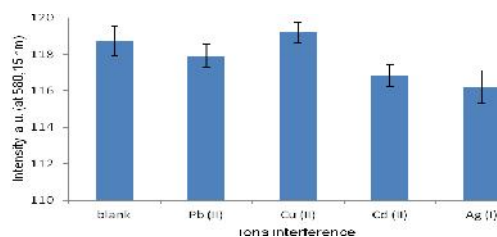

Figure 4. Biosensor responses versus Interference

Table 2. Determination of Hg(II) in aquatic samples

S	Various Water Samples	The biosensor ppb	AAS (std Hg(II)) ppb
1	buffer	0.00	0.00
2	Tap water	0.00	0.00
3	River water	0.003±0.02	0.00
4	Sea water	44.90±0.02	40.20

*average of triplicate measurements.

4. Conclusions

Urease has been co-immobilised with brom thymol blue (BTB) by entrapment method in alginate–chitosan PEC membrane for determination as optode biosensor development is easily prepared, stable and a simple method for the determination of Hg(II). The difference in the pH changes before and after inhibition was proportional to the number of ions Hg(II) in the sample solution. In the presence of constant urease, a color change of BTB from yellow to green and the measured reflected signal intensity at 580.15 nm and pH of 6 could be related to Hg(II) concentration in sample solution. After optimization of experimental parameters, the biosensor has a linear response in range of 10 to 500 ppb, detection limits; ($I_{10\%}$) was 12.1 ppb, and highly coefficient of variation (0.86%). The optode biosensor was applied for the determination of Hg(II) in aquatic system, which was shown in good agreement with reference method (AAS).

Acknowledgement

The authors are grateful to the Minister of Research Technology and Dikti, Republic of Indonesia (Kemenristekdikti) for support of this work.

References

- [1] J. Zehnalek, V. Adam, R. Kizek, Influence of heavy metals on production of protecting compounds in agriculture plants, *Listy Cukrov*, 120(2004), p.222.
- [2] R. Kizek, J. Vacek, L. Trnkova, B. Klejdus, V. Kuban, Electrochemical biosensors in agricultural and environmental analysis, *Chem. Listy*, 97(2003), p.1003.
- [3] B. Sures, Environmental parasitology: Relevancy of parasites in monitoring environmental pollution, *Trends Parasitol*, 20(2004), p.170.
- [4] Aminea, H. Mohammadia, I. Bourais, G. Palleschi, Enzyme inhibition-based biosensors for food safety and environmental monitoring, *Biosens and Bioelectron*, 21(2006), p.1405.
- [5] S. Yabuki, Polyelectrolyte complex membranes for immobilizing biomolecules, and their applications to bio-analysis, a review, *Analytical Sciences*, 27(2011), p.695
- [6] M.C.P. Cruz, P. Sergio, P. Ravagnani, M.S. Fabio, Brogna, Evaluation of the diffusion coefficient for controlled release of oxytetracycline from alginate/chitosan/poly (ethylene glycol) microbeads in simulated gastrointestinal environments, *Biotechnologi. Appl. Biochem*, 40(2004), p.243.
- [7] B. Kuswandi and N.W. Suwandari, A simple and sensitive flow injection optical fibre biosensor based on immobilised enzyme for monitoring of pesticides, *Sensors and Transducers Journal*, 76(2007), p.978.
- [8] N.E. Azmi1, J. Abdullah1, M. Ahmad, H. Sidek, L.Y. Heng, S.A. Rahman, An optical based biosensor for the determination of ammonium in aqueous environment, *American Journal of Analytical Chemistry*, 3(2012), p.364.

Inhibitive Determination of Hg (II) in Aqueous Solution Using a Urease Amperometric Biosensor

Dhony Hermanto^{1*}, Mudasir², Dwi Siswanta², Bambang Kuswandi³

¹Department of Chemistry, Faculty of MIPA – University of Mataram, West Nusa Tenggara 83125, Indonesia

²Department of Chemistry, Faculty of MIPA – University of Gadjah Mada, Yogyakarta 55281, Indonesia

³Chemo and BioSensor Research Group, School of Pharmacy – University of Jember, Jember 68121, Indonesia

* Email: dhony.hermanto@gmail.com

Abstract

An amperometric biosensor for the indirect determination of Hg (II) was developed by inhibition of urease immobilized into alginate–chitosan polyelectrolyte complexes membrane by using sol–gel technique. Some factors that affect biosensor response were studied, such as temperature and pH. Optimum conditions for biosensor were found as: operating potential 0,02 V vs Ag/AgCl, enzyme load 0.56 U/mm² electrode surface, supporting electrolyte: 0.1 M phosphate buffer (pH 7). The current response of the biosensor in hydrodynamic amperometry was linearity dependent on the concentration within 40 – 90 ppm Hg (II) with a detection limit of 29 ppm. The enzymatic activity could be fully recovered by exposure of the electrode to a solution of EDTA (0.1 M) for 2 minutes. The analytical characteristics of the biosensor prepared toward Hg(II) are described. Analytical results of spiked water sample showed a good correlation with determinations by atomic absorption spectrometry where the difference is not statistically significant at 95% confidence level. The sensor yielded a stable and reproducible response more than 2 weeks when stored dry at 4 °C.

Key words: *Amperometric biosensor, Urease, Inhibition, Hg (II)*

1 Introduction

Industries produce a number of undesirable species such as pesticides, toxic organic compounds, heavy metals and so on [1,2]. That is why easy and quick detection of heavy metals at very low concentrations levels in environmental and biological samples is necessary for assurance against acute intoxications and, first of all, against long-time exposure that may lead to many diseases and death [3]. The biosensors have superior properties over the other existing measurement systems because they can provide rapid, simple and low-cost on-field determination number of metal ion, such as amperometric biosensors [4,5]

Domínguez-Renedo et al. [6] developed enzymatic amperometric biosensors for the measurement of Hg²⁺, based on the inhibitory action of this ion on urease activity. They used screen-printed carbon electrodes as support and screen-printed carbon electrodes modified with gold nanoparticles. Polyelectrolyte complexes (PEC) used as membrane for enzyme immobilisation, it has been reported that immobilized enzymes retain higher activities than native enzymes and were stable [7]. For these reasons, PEC are potentially attractive materials for applications in biotechnology, including biosensor. Alginate as polyanion and chitosan as polycation when dissolved in appropriate condition can interact each other through carboxyl group of alginate and amino group of chitosan [8] and its ionic interactions are the main interactions inside the network.

A simple and fast immobilisation method is described based on chemically synthesised alginate-chitosan membrane and their application in amperometric biosensing for determination Hg(II) in aqueous solution. The optimised condition for urease immobilisation

was defined and the effects of pH and temperature on the amperometric biosensor response and the stability of the biosensor are studied as well as its analytical characteristics.

2 Materials and Methods

The urease used for preparing the biosensor was E.C. 3.5.1.5. from jack beans, Type III, U1500, 272 μg was stored at 40C, sodium alginate was 300–400 cp from brown algae, and chitosan was 95% deacetylated from crab shell were purchased from Sigma (St. Lois, USA). Hydrochloride acid (37%), glacial acetic acid (98%), sodium hydroxide, potassium dihydrogenphosphate (KH_2PO_4) and sodium tetraborate ($\text{NaB}_4\text{O}_7 \cdot 10\text{H}_2\text{O}$) were received from Merck (Germany). Stock solution of urea (1000 $\mu\text{g}/\text{mL}$) was prepared in aqueous solution. $\text{Hg}(\text{NO}_3)_2$, AgNO_3 , $\text{Cd}(\text{Cl})_2$, CuSO_4 , $\text{Pb}(\text{NO}_3)_2$ solutions were prepared by appropriate dilution. All other reagents were analytical grade and were used without further purification. All the electrochemical measurements have been conducted by using an PalmSens Electrochemical Portable Apparatus (Palm Instrument BV, Houten, The Netherlands).

2.1 Preparation of membrane

Membrane was prepared by mixing two polymer solution, chitosan and alginate solutions. Chitosan solution was obtained from 1 g of chitosan was dispersed into 25 ml distilled water and then dissolved by adding 5 ml of glacial acetic acid with stirring using a magnetic stirrer to form a homogeneous mixture. Furthermore, alginate solution was prepared by dissolving 1 g of alginate in 25 ml of distilled water, then the solution was allowed one night. The formed polymer was complex alginate-chitosan sol-gel.

2.2 Immobilisation procedure

PEC membrane alginate-chitosan is used as the supporting material (solid support) for enzyme immobilisation. Immobilisation of urease on sol-gel glasses has been performed in three steps: (i) preparation of sol solution from mixer both polymer of 50 ml alginate-chitosan, 2 ml of 32% HCl, and then added a solution of NaOH 10% (w/v) to obtain a pH = 5.28. Then, the mixture was stirred until homogenous. (ii) immobilisation of urease. Here, 3 ml sol, 1 ml phosphate buffer (pH 6.5) and 3 ml urease was stirred for ± 4 hours in room temperature. Afterwards, the sol-gel was transferred to the glass mould with 1 mm dept in order to produce glass block of sol-gel. (iii) ageing process. Then the glass block was stored at 40C for 24 hours for ageing process.

2.3 Construction amperometric biosensor

Construction PalmSens Electrochemical, PEC membrane alginate-chitosan coated on Screen Printed Electrode (SPE), immobilisation of urease was packed onto an electrode surface. In the presence of increasing amount of $\text{Hg}(\text{II})$ and a constant substrate concentration, the activity of the enzyme decrease so that signal of the sensor are measured using an PalmSens.

3 Result and Discussion

Fig. 1 show that the scanning potensial between -0,5 – 0,5 V displays very good redox activity at pH 7. Cyclic voltamogram blue as a base line, was current from urea in phosphate buffer pH 7. Cyclic voltamogram red as an inhibitive urease with $\text{Hg}(\text{II})$ in urea solution pH

7. With repetitive cycling of the potential an increase in the redox peaks was observed, which indicated the formation of a complexing polymer as membrane for immobilisation urease on the electrode surface. Determination of operating optimum parameters is initial investigation performance for amperometric biosensors of Hg(II). Table 1 shows some parameters were investigated and their optimum value. Phosphate buffer solution used for the enzymatic reaction with a pH of 7, which is reaction enzymatic between the sample and reagent is optimum.

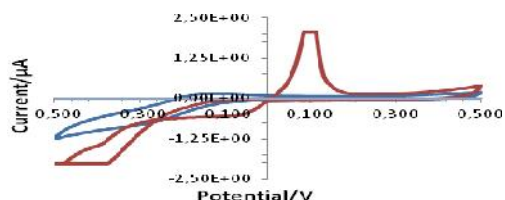

Figure 1. Cyclic voltammogram urease biosensors with urea 10 ppm, buffer pH 7, scan rate 1 V/s

Table 1. Optimization of experimental parameters

Parameter	Range	Optimum
pH	5–8	7
Substrate/Urea (mM)	10–80	70
Respon time (s) with scan rate 1 V/s	0–8	4
Temperature (°C)	20–35	25

By applying the optimised parameters above (table 1), the dynamic response to Hg(II) was monitored, when the amperometric biosensor was performed by flowing buffer solution, substrates, inhibitors and reactivator alternately with variations of metal concentration (inhibitor) (Fig. 2). Response curve obtained for different concentration of Hg(II) shows a linear curve in the concentration range 40–90 ppb (Fig. 3). Fig 3 also shows the relationship between the reflected signal and low concentration of Hg(II) from 40–90 ppb, with the correlation coefficient (*r*) is 0.9617 (each point was the average of three injections). As can be seen from Fig. 3, there is a linear correlation between absorbance of the biosensor and concentration of Hg(II) for the interval range of 40 – 90 ppb of Hg(II), with a regression equation of %I = 0,0002 [Hg (II)] – 0,0352. The detection limit is determined by using analyte concentration when Hg(II) inhibit enzyme for 10%. It was chosen because it assumes that at intensity is 10%, differences before and after inhibition can be observed with 90% confidence level, I10% = 29 ppb for Hg(II). The obtained repeatability of the biosensors (coefficient of variation, Cv= 0.86%) is no significant different (<5%), so it can be concluded that obtained data has high precision.

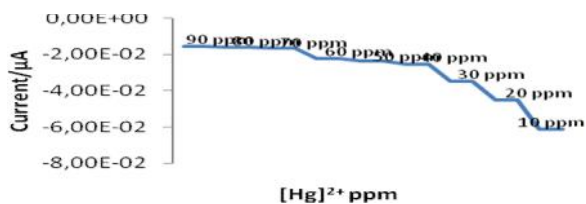

Figure 2. Average response curve of inhibited Hg(II) urease biosensor with variation of concentration

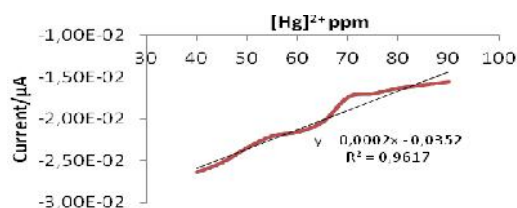

Figure 3. The calibration plot of Hg(II) inhibition vs Log Hg(II) concentration

Fig. 4 shows that the obtained relative value of inhibition was very small (<5%), indicating that ions Pb (II), Cu (II), Cd (II) and Ag (I) were not significant interference. However, the Ag (I) have a relatively large value compared with other ions, this is because Ag (I) at high concentrations will affect the inhibition enzyme activity by metals [9]. To evaluate the ability of the optode biosensor prepared to carry out the analysis of aquatic samples. The standard addition method was used and sample spiking with different amount of Hg(II) were analysed, as described above. Since, the result shown in Table 2 was in good agreement with reference method using atomic absorption spectrometry (AAS).

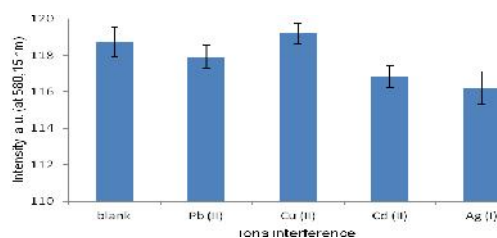

Figure 4. Biosensor responses versus Interference

Table 2. Determination of Hg(II) in aquatic samples

S	Various Water Samples	The biosensor ppb	AAS (std Hg(II)) ppb
1	buffer	0.00	0.00
2	Tap water	0.00	0.00
3	River water	0.003±0.02	0.00
4	Sea water	44.90±0.02	40.20

*average of triplicate measurements.

4. Conclusions

Optimum conditions for biosensor were found as: operating potential 0,02 V vs Ag/AgCl, enzyme load 0.56 U/mm² electrode surface, supporting electrolyte: 0.1 M phosphate buffer (pH 7). The current response of the biosensor in hydrodynamic amperometry was linearity dependent on the concentration within 40 – 90 ppm Hg (II) with a detection limit of 29 ppm. The enzymatic activity could be fully recovered by exposure of the electrode to a solution of EDTA (0.1 M) for 2 minutes. The analytical characteristics of the biosensor prepared toward Hg(II) are described. Analytical results of spiked water sample showed a good correlation with determinations by atomic absorption spectrometry where the difference is not statistically significant at 95% confidence level. The sensor yielded a stable and reproducible response more than 2 weeks when stored dry at 4 °C.

Acknowledgement

The authors are grateful to the Minister of Research Technology and Dikti, Republic of Indonesia (Kemenristekdikti) for support of this work.

References

- [1] J. Zehnalek, V. Adam, R. Kizek, Influence of heavy metals on production of protecting compounds in agriculture plants, *Listy Cukrov*, 120(2004), p.222.
- [2] R. Kizek, J. Vacek, L. Trnkova, B. Klejdus, V. Kuban, Electrochemical biosensors in agricultural and environmental analysis, *Chem. Listy*, 97(2003), p.1003.
- [3] G. Nordberg, T. Jin, P. Leffler, M. Svensson, T. Zhou, M. Nordberg, Metallothioneins and diseases with special reference to cadmium poisoning, *Analysis*, 28(2000), p.396.
- [4] M.R. Guascito, C. Malitesta, E. Mazzotta, A. Turco, Inhibitive determination of metal ions by an amperometric glucose oxidase biosensor study of the effect of hydrogen peroxide decomposition, *Sensors and Actuators B*, 131 (2008) 394–402
- [5] A.Amine and H. Mohammadi, Determination of methyl mercury in fish tissue using electrochemical glucose oxidase biosensors based on invertase inhibition, *Comprehensive Analytical Chemistry*, 49 (2007), p.139
- [6] O. Domínguez-Renedo, M.A. Alonso-Lomillo, L. Ferreira-Gonçalves, M.J. Arcos-Martínez, Development of urease based amperometric biosensors for the inhibitive determination of Hg (II), *Talanta*, 79(2009), p.1306.
- [7] S. Yabuki, Polyelectrolyte complex membranes for immobilizing biomolecules, and their applications to bio-analysis, a review, *Analytical Sciences*, 27(2011), p.695
- [8] M.C.P. Cruz, P. Sergio, P. Ravagnani, M.S. Fabio, Brogna, Evaluation of the diffusion coefficient for controlled release of oxytetracycline from alginate/chitosan/poly (ethylene glycol) microbeads in simulated gastrointestinal environments, *Biotechnologi. Appl. Biochem*, 40(2004), p.243.
- [9] N.E. Azmi1, J. Abdullah1, M. Ahmad, H. Sidek, L.Y. Heng, S.A. Rahman, An optical based biosensor for the determination of ammonium in aqueous environment, *American Journal of Analytical Chemistry*, 3(2012), p.364.

Activated Carbon Composites from Rice Husk as an Adsorbent Textile Waste

Dian W. Kurniawidi^{1*}, Cici Andayani¹, Siti Alaa¹, Susi Rahayu¹

¹*Department of Physics, Faculty of Mathematic and Natural Science, Universitas Mataram
Jl. Majapahit 62, Mataram 83125, Lombok, Nusa Tenggara Barat
email : dkurniawidi@gmail.com

Abstract

One of the methods used in dealing with textile waste is by using activated carbon as adsorbent. The aims of this research is to determine the effectiveness of activated carbon from rice husks as adsorbent textile waste by measuring the adsorption process, the level of turbidity, and the amount of light transmitted by adsorption solution result. Activated carbon is made from rice husk with carbonized temperature 500°C, 700°C and 900°C and also with various concentrations of activator H₃PO₄ 0:10, 1: 9, 3: 7 and 5: 5 using a simple heating method. Activated carbon is then formed into a composite using the adhesive glue PVaC with a press method. From the results, we get that the activated carbon composites that have good adsorption capacity of activated carbon is a composite with carbonization temperature of 900 °C with turbidity levels resulted by different concentration of H₃PO₄ respectively are 3.26 NTU, 6.81 NTU, 3, 45 NTU and 6.35 NTU. That result indicated that the turbidity level is moderate that include in clean water category. While the intensity of light produced are 46 lux, 101 lux, 229 lux and 1987 lux. The value of light intensity is increasing due to the reduction of dyes in textile waste.

Keywords : *adsorbent, activated carbon, light intensity, turbidity, textile waste.*

1. Introduction

Water pollutions are very dangerous things that threaten long-lasting environment and human live. Nowadays, human activities and industrial agent causes many diseases and produce pollutant that destroy our environment. Primary color often use by consumer is blue metilen (C₁₆H₁₈N₃SCl). Negative effects by using this color are skin irritation, digestive irritation and cyanosis [1].

Many methods developed to reduce pollution, there are precipitation, coagulation, flocculation, extraction, membrane separation, ion exchange, reverse osmosis and adsorption [2]. In this research, we use an adsorption method. This is an efficient method and very competitive to reduce pigmentation, heavy metal and material or another dangerous compound like organic and an organic pollutant from liquid waste [3]. Many research used activated carbon as adsorbent, activated carbon was from charcoal and activated using H₃PO₄ [4,5]. In this research, we sensitized activated carbon from rice husk and H₃PO₄ as activator. Activated carbon then use as adsorbent for textile waste.

2. Materials and Methods

Synthesis of activated carbon is done through two processes, namely carbonization and activation. In carbonization process, rice hulls washed then dried and furnaces. Dilution activation process using H₃PO₄ solution by ratio H₃PO₄ solution and distilled water are 1: 9, 3: 7, and 5: 5. The result is then smoothed using a mortar and sieved, The results of the sieve soaked with H₃PO₄ solution with a concentration of dilution of 1: 9 for 24 hours.

The activation process can be divided into two process, the activation of chemistry and physics. Chemical activation is done using a solution of H_3PO_4 activator. Carbon that has been soaked for one day then filtered using filter paper. While the physical activation is done by the simple method of heating for drying rice husk carbon that has been chemically activated using the oven at $150^{\circ}C$ for 2 hours. The final step is manufacturing the composite, by mixing the starch glue and white eagle glue with activated carbon.

After mold using press machine, composite carbonize in different temperature $700^{\circ}C$ and $900^{\circ}C$. We measure the absorption time using a stopwatch, measure the turbidity using turbidimeter turbidity levels, and the light intensity measurement is using a luxmeter.

3. Result and Discussion

Wastewater adsorption process is done by placing activated carbon composite into a measuring glass as in Figure 1.



Figure1. Schematic Diagram to adsorb liquid waste

The adsorption process was conducted to determine the effectiveness of activated carbon produced by variations of temperature and concentration of activators. The results can be seen in the Figure 2.

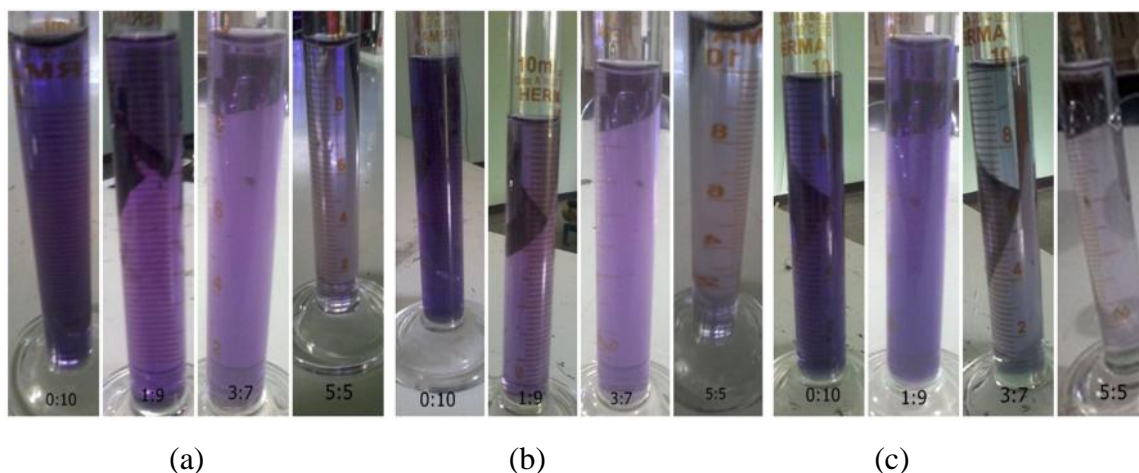

Figure2. Product of an adsorbing liquid waste at various temperature (a) $500^{\circ}C$ (b) $700^{\circ}C$ (c) $900^{\circ}C$

From Figure 3, we can see that the sample has a turbidity value optimal for liquid waste adsorption results with a temperature of $900^{\circ}C$. Although the level of turbidity

produced has a higher value than the initial state, but the liquid waste adsorption results can still be categorized as clean water because the maximum requirement for clean water is less than or equal to 25 NTU,

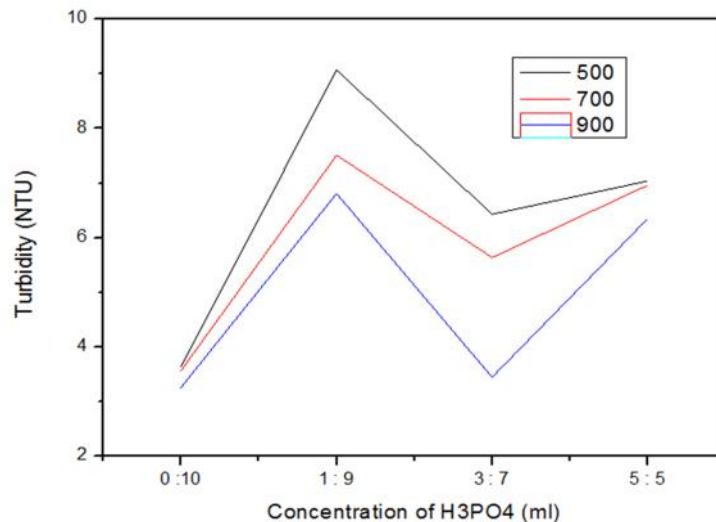

Figure3. Correlation between Turbidity Level and Concentration of H₃PO₄

Wastewater before adsorption has a light intensity of 39 lux. After treatment, the intensity of waste water decrease as presented in Figure 4. Highest light intensity occurs at 900oC sample with the concentration of H3PO4 activator used was 5: 5. This happens because the temperature can activate the pores of the carbon. The purpose of the activation process is to enlarge the pores so that the surface area of activated carbon is increasing. If the surface area is increasing, the capability of carbon to adsorb waste water is increasing.

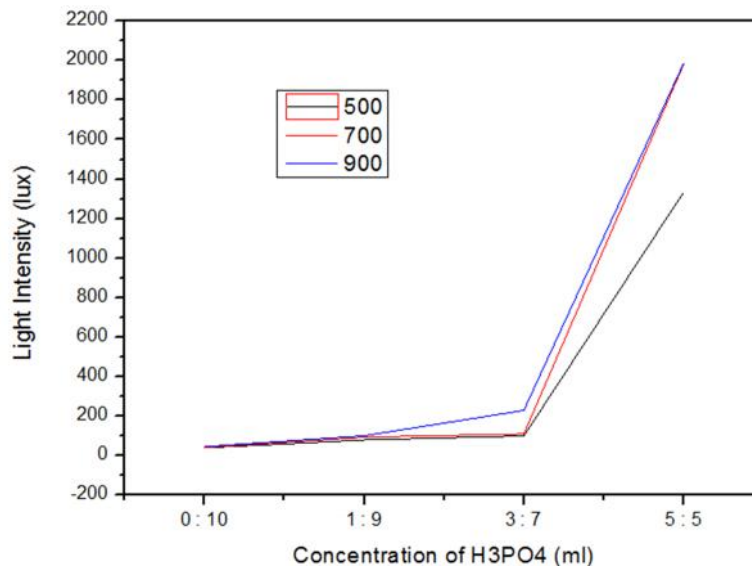

Figure 4. Correlation between Light Intensity and Concentration of H₃PO₄

4. Conclusion

The activated carbon composites that have good adsorption capacity of activated carbon is a composite with carbonization temperature of 900°C with turbidity levels resulted by different concentration of H₃PO₄ respectively are 3.26 NTU, 6.81 NTU, 3, 45 NTU and 6.35 NTU. The result indicated that the turbidity level is moderate that include in clean water

category. The intensity of light produced are 46 lux, 101 lux, 229 lux and 1987 lux. The value of light intensity is increasing due to the reduction of dyes in textile waste.

Acknowledgement

This work is supported by the fund of the PNBP by Universitas Mataram 2016.

References

- [1] Hamdaoui, O. and Chiha, M. 2006. *Removal of Methylene Blue from Aqueous Solutions by Wheat Bran*, ActaChim. 54 : 407–418.
- [2] Stumm, W., and Morgan J.J. 1981. *Aquatic Chemistry*. New York : John Wiley & Son Inc.
- [3] Annadurai, Juang R.S. and Lee D.J. (2002). *Factorial Design Analysis of Dye on Activated Carbon Beads Incorporated with Calcium Alginate*. Journal of advance Environment of Research. 6: p. 191.
- [4] AnggunPradilla, Astuti, Sandi. 2014. *Pengaruh Waktu Aktivasi Menggunakan H₃po₄ Terhadap Struktur Dan Ukuran Pori Karbon Berbasis Arang Tempurung Kemiri (Aleurites Moluccana)*. Padang : Jurnal Fisika, Universitas Andalas.
- [5] Erprihana, A.A., dan Dhoni Hartanto. 2014. *Pembuatan Karbon Aktif Dari Kulit Jeruk Keprok (Citrus Reticulata) Untuk Adsorpsi Pewarna Remazol Brilliant Blue*. Semarang: Jurnal Teknik Kimia.

Early Detection of Newborn Hearing Impairment: The Useful of Mobile Application

Hamsu Kadriyan, Sapto Sutardi

Medical Faculty, University of Mataram

Abstract

The incidence of newborn hearing impairment in the world is about 1-3 of 1000 live births. If the treatment was decided lately, a severe social effect will occur such as speech impairment. On the other hand, an increasing of mobile phone was surprising all over the world, including Indonesia. In the last periods, the most familiar mobile phone is smart phone, which have some advantages to operated any application to help people to do their work. For instance, application to make a diagnosis of specific disease, such as the early detection of hearing impairment. Aim of study was to measure the usefulness of mobile application that writer developed on early detection of newborn hearing impairment. This study design with cross sectional methods. Subject on this study including general practitioner with inclusion criteria were subject should have a smart phone, based on android or ios, agree as subject. Subject will be excluded if he/she didn't answer the questionnaire. The step of study including : 1. Development of mobile application; 2. Application trial; 3. Installing application to subject smartphone; 4. Application trial by subject; 5. Filling a questionnaire by subject; 6. Statistical analysis. During period of study, there are 41 subject enrolled to this study, consist of 20 male (49%) and 21 female (51%) with the mean of age is 26,1 years old. Based on perception of easiness of application installation, most of subject said that very easy to install (75,6%), easy (24,4%) and none of them said difficult or very difficult. Based on perception easiness to use the application, most of subject said that very easy to use (70,7%) and the remaining said easy (29,3%) and none of them said difficult or very difficult. In the aspect of features, 44 % said that application is very interesting and 49% interesting, but there are 4,8% said common sense and also 2,4% said that the features is not interesting. However, 21 subject (51,2%) and 20 (48,8%) consecutively said that this application is very useful and useful to help them to diagnosed the newborn hearing impairment. The conclusion of this research was mobile application on newborn early detection of hearing impairment is very useful (51,2%) to help general practitioners on their duty.

Keywords : *mobile application, newborn, hearing impairment, general practitioners*

1. Introduction

Wireless technology is getting more popular worldwide, especially mobile phone devices. Almost all people have this devices nowadays¹ and it's used are significant to changed informatics system generation.² Furthermore, it can become increased or changed a personal computer (PC) function. For instance, mobile phone can perform quicker execution than PC in some application feature^{3,4} although it has small memory and processor.⁵

The characteristic of mobile phone are as follows: 1) more economical than PC; 2) more efficient in some work; 3) it have some PC program and low energy needed.^{6,7} In general, mobile phones becoming popular in society. Almost 60% population using this devices on daily activities and several scientist agreed that it will be increased in this era.⁸

2.1. Smart Phone and It's Application

One of special variance of mobile phones is smart phone. This is because smart phone is inserted with a PC operation. According to Indonesian bodies for telecommunication regulation (BRTI) 2015, the number of smart phone users in Indonesia 281,9 million, whereas in worldwide reach 1,86 billion or 25% population.⁹ In the end of 2015 the user is increase

until 37%, according to PEW research center.¹⁰

To make a smart phone functionally work, it should have software (application). An excellent software should fulfill a user needed. So it is necessary to decide or to know the user needed. Several advantages of software can be reached as long as it fulfill a user needed. For instance, to help early detection of hearing impairment in children, writer should developed a specific software for this purposes.^{11,12}

2.2. Hearing Impairment in Newborn and It's Effect

Congenital hearing impairment has been recognized for decades as a serious disability for affected children. Studies showed that newborns that have significant hearing impairment are estimated to range from 1 to 3 per 1000 live births.¹³ In Mataram, West Nusa Tenggara, Indonesia, based on hearing screening in neonatal intensive care unit, the incidence of hearing impairment were relatively high as well as 12% of newborn baby.¹⁴

The importance of normal hearing in the psychological and social development of children is unquestionable. Hearing loss may have significant adverse effects on the development of speech, language capabilities and social-emotional development, as well as lead to worse educational and occupational performance in adulthood. Thus, hearing disorders need to be detected as early as possible.¹⁵

2.3. Mobile application in health purposes

Several application or software are used to health purposes. Sutardi et al (2010) have developed a software to help general practitioner to make a diagnosis and treatment of malnutrition. Kadriyan and Sutardi (2014) has developed a software to early detection of hearing impairment in children based on standard indicators from otorhinolaryngologist society. The software can guided a practitioner such as midwife or general practitioner to early diagnosed the hearing impairment in newborn or children (figure 1).

2.4. Aim of Study

The aim of this study is to measures the usefulness of mobile application that writer developed to early detection a newborn hearing impairment.

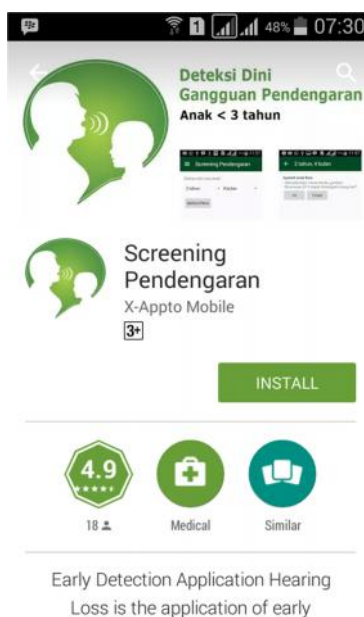

Figure 1. Application of early detection in Newborn hearing impairment

2. Materials and Methods

This study is design with cross sectional. Subject on this study including general practitioner with inclusion criteria were subject should have a smart phone, based on android or ios, agree as subject. Subject will excluded if he/she didn't answer the questionnaire. The step of study are as follows : 1. Development of mobile application which is based on android or ios program; 2. Application trial was tried by few practitioner in real patient, a good result were collected; 3. Installing application to subject smartphone by downloading the application application store; 4. Application trial by subject; 5. Filling a questionnaire by subject to knows their perception to this application; 6. Statistical analysis was done by descriptive analysis.

3. Results and Discussion

During period of study, there are 41 subject enrolled to this study, consist of 20 male (49%) and 21 female (51%) with the mean of age is 26,1 years old. Detailed data distribution can be seen in figure 2.

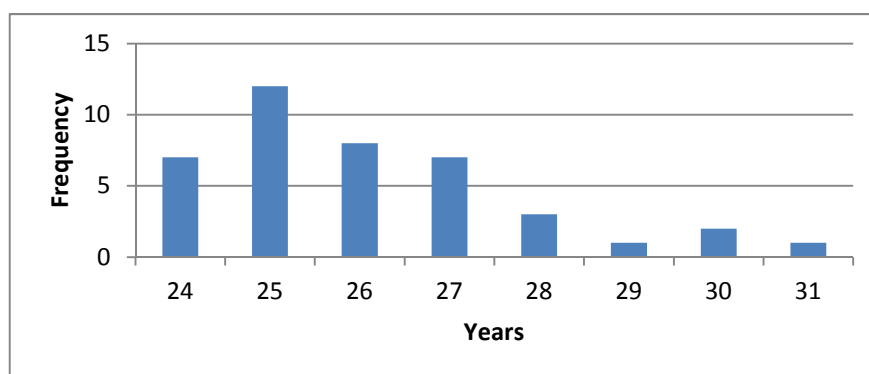

Figure 2. Age distribution

Several characteristic were analyzed on this study, including perception of easiness to installed an application or software on smart phone, perception of easiness to use an application or software, application or software feature and the usefullness of application or software on their daily practices.

Based on perception to easiness of application installation, most of subject said that very easy to install (75,6%), easy (24,4%) and none of them said difficult or very difficult (Figure 3). Based on perception to easiness to use the application, most of subject said that very easy to use (70,7%) and the remaining said easy (29,3%) and none of them said difficult or very difficult (Figure 4). In the aspect of features, 44,% said that application is very interesting and 49% interesting, but there are 4,8% said common sense and also 2,4% said that the features is not interesting (Figure 5).

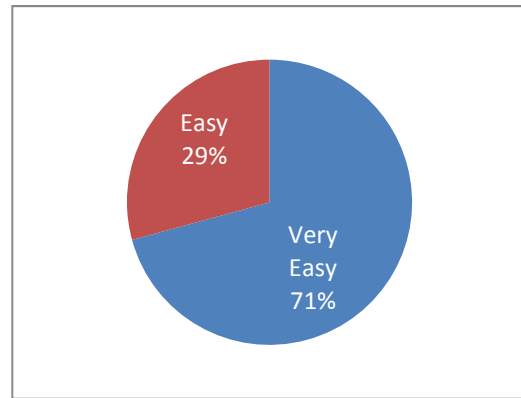
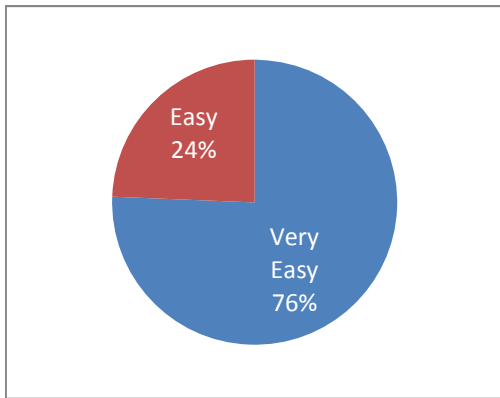

Figure 3. Perception of easiness to installed **Figure 4. Perception of easiness to use**

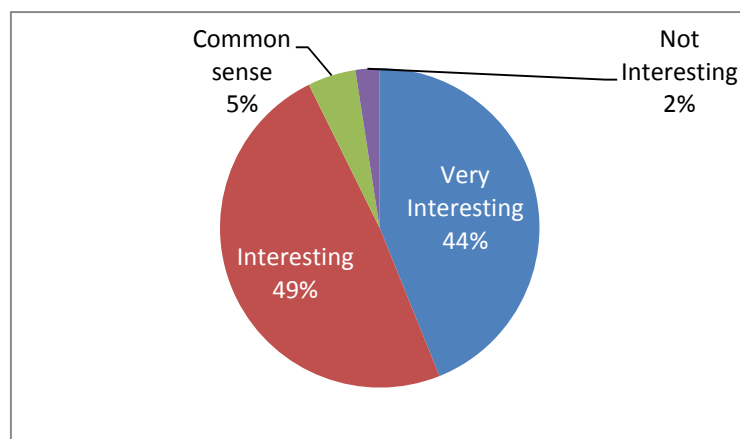

Figure 5. Perception to application features

There were 21 subjects (51,2%) said that this application is very useful to help them to diagnosed the newborn hearing impairment on their daily practices (Figure 6). This result were similar with several studies who developed an application for health purposes. Offiah MC, et al. (2014),¹⁸ found that smart phone application was very useful in replacement of hearing aid function. This studies also congruent with Tobias AP et al (2015),¹⁹ with their result was smartphone application was make clinicians easier to understand the clinical genomics terminology.

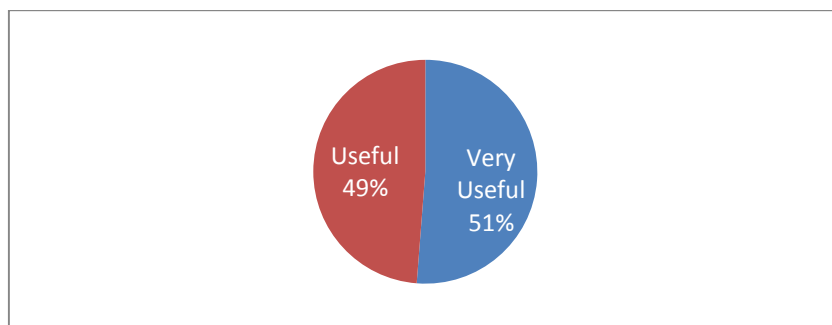

Figure 6. Perception of usefulness

4. Conclusion

Mobile application on Newborn early detection of hearing impairment is very useful (51,2%) to help general practitioner on their duty.

References

- [1] Klingsheim, André N.. 2004. J2ME Bluetooth Programming.-. The No Wires Research Group. Available from: <https://bora.uib.no/>.
- [2] Whitten, Jeffrey L., et. al.. 2004. Motode Desain dan Analisis Sistem. Yogyakarta: Andi.
- [3] Sun Microsystems. 2009. Java™ 2 Platform, Micro Edition (J2ME™) Web Services, For the Java™ 2 Platform, Micro Edition. Santa Clara: Sun Microsystems. Available from: <http://java.sun.com/>.
- [4] Narsoo, J and Mohamudally, N. 2008. Issues in Informing Science and Information Technology, vol. 5 ed. 2008: Identification of Design Patterns for Mobile Services with J2ME. California: Informing Science Institute <http://proceedings.informingscience.org/>.
- [5] Steiner, Urs. 2001. J2ME: Introduction, Configurations and Profiles. Zürich, University of Zürich. Available from: <http://www.ifi.uzh.ch/>.
- [6] Efrain, Turban, R. Kelly Rainer, and Richard E. Potter. 2006. Pengantar Teknologi Informasi, Terjemahan Introduction to Information Technology. Jakarta: Salemba Infotek
- [7] JENI (2007). Pengembangan Aplikasi Mobile. - . JENI. Available from: <http://poss.ipb.ac.id/>.
- [8] Daily Mail. 2008. Mobile phone use explodes as 60% of the world's population signs up for a handset. <http://www.dailymail.co.uk/>.
- [9] Anonim. 2016. Population, total. <http://data.worldbank.org/indicator/SP.POP.TOTL.->, The World Bank.
- [10] Poushter, Jacob. 2016, "Smartphone Ownership and Internet Usage Continues to Climb in Emerging Economies". Pew Research Center.
- [11] Guzdial, Mark. 1999. Designing User Interface, chapter 6. Designing User Interfaces in Squeak. Available from: <http://stephane.ducasse.free.fr/>
- [12] Nugroho, Adi. 2002. Analisis dan Perencanaan Sistem Informasi dan Metodologi Berorientasi Objek. Bandung, Informatika Bandung.
- [13] Barsky-Firkser L, Sun S. Universal newborn hearing screenings: a three-year experience. Pediatrics. 1997;99(6):133-138.
- [14] Kadriyan H, Rambu M, Trisna IGA. Newborn hearing screening in neonatal intensive care unit in Mataram General Hospital, West Nusa Tenggara. 2008. Presented as poster in Otologic annual meeting Bandung.
- [15] J.M. Davis, J. Elfenbein, R. Schum, R.A. Bentler, Effects of mild and moderate hearing impairments on language, educational, and psychosocial behavior of children, J. Speech Hear. Disord. 51 (1) (1986) 53e62.
- [16] Sutardi S. Z-saptors score in diagnosis and treatment of malnutrition. Patent Awarded by HAKI 2010.
- [17] Kadriyan H, Sutardi S. Mobile application in early detection of newborn hearing impairment. Report of community services program, Medical Faculty, Mataram University 2014.
- [18] Offiah MC, Rosenthal S, Borschbach M. Assessing the Utility of Mobile Applications with Support for or as Replacement of Hearing Aids. Procedia Computer Science 34 (2014) 593 – 600.
- [19] Tobias AP, Tobias ES. Developing educational iPhone, Android and Windows smartphone cross-platform apps to facilitate understanding of clinical genomics terminology. Applied & Translational Genomics 6 (2015) 15-17

Incorporate Computational Chemistry as an Alternative for Chemistry Laboratory Work at High School Level

Saprizal Hadisaputra¹, Lalu RudyatTelly Savalas¹, Sapriani Hamdiani²

1Chemistry Education Division, Faculty of Mathematics and Science Education, Mataram University, Indonesia

2Chemistry Division, Faculty of Mathematics and Natural Science, Mataram University, Indonesia

**Email: rizal@unram.ac.id*

Abstract

Carrying out chemistry laboratory activities at high school level in Indonesia is a challenging task. Lack of equipment, chemicals, cost, and even worst no laboratory infrastructures force wet laboratory practice hardly exist in most high schools in this country, especially at Lombok Island, West Nusa Tenggara province. This pilot project focused on incorporate computational chemistry as an alternative for chemistry laboratory work at high school level. It describes the effectiveness of computational chemistry software for replacing wet laboratory practice. We have studied what topics are essential and what topics are student struggled with, chosen computational chemistry software and conducted teacher motivation survey. This project is promising and has a strong impact in the future but improving the current high school technology is a necessity.

Keywords: *computational chemistry, high school, laboratory.*

1. Introduction

Chemistry lab is one of the core activities on chemistry learning included in the level of high school. However, the implementation of the chemistry lab faced many obstacles in Indonesia (Coppola, 2008). The high workload of teachers lead to less motivated to plan, prepare and conduct the chemistry lab. The other obstacles are the expensive cost of laboratory practice, time consuming, limited equipment and chemicals (Jansen-van Vuuren, 2013) as well as the possible dangers during chemistry practicum. In addition, many high schools in Indonesia do not have a chemical laboratory infrastructure, no laboratory building and waste treatment plan. It makes chemistry practicum did not go well so that chemistry learning process does not produce the optimum result.

Chemistry is a science-based theory and experiment. Theory without chemistry laboratory practice leads to the students miss understanding of the chemistry key concepts. Many chemistry topics are abstract in concepts so that it is considered difficult. Absorbing these abstract topics within a relatively limited time with no chemistry laboratory practicum makes many students fail in chemistry class. In addition, the learning process emphasizes only on the theory without practical would be boring and less attracting.

Applying computational chemistry as an alternative chemistry lab is a solution for this problem. Computational chemistry methods are very flexible. All topics on the chemistry lab ranging from simple level to level difficult can be easily modeled using computational chemistry. The availability of a wide range of computational chemistry software for free can be used by teachers as a substitute for chemistry lab at the school (Fortenberry, 2015). The other advantages of using computational chemistry as an alternative for practicum in high schools is low cost, highly accuracy, less time consumption, harmless and certainly help improve students'

understanding of chemical topics (Sendlinger and Metz, 2010; Ochterski, 2014).

2. Materials and Methods

The aims of this project are to determine the most suitable software for lab-based computational chemistry in high school. Secondly, to determine the essential chemistry topics for computational chemistry based practicum. Thirdly, to study the teacher motivation to implement lab work in chemistry learning process. Based on the above objectives, the methodology of this project are a survey of chemistry topics, software review, and implementing a lesson plan. This pilot project was sampling two high schools: SMAN 1 Narmada and SMAN 2 Narmada at Lombok Island, West Nusa Tenggara province, Indonesia.

3. Results and Discussion

3.1. Program Review.

Some programs were reviewed as a prime candidate to be used as alternative for replacing the lab work in high school. The program can be seen in Table 1. The program selected based on ease of installation, ease of use, and compatibility with chemical topics.

Table 1. Potential Program Features

No	Program	Web based	Easy to Install	Easy to Use 1= very difficult 5 = very Easy	Finalist
1	NWChem* ¹	No	No	2	No
2	Hyperchem ²	No	Yes	4	Yes
3	Gaussian ³	No	Yes	2	No
4	Chemlab ⁴	No	Yes	5	Yes
5	WebMo ⁵	Yes	No	4	No
6	ACD/ChemSketch ⁶	No	Yes	5	No

*1. Valiev, 2010; 2. Froimowitz, 1993; 3. Frisch, 2004; 4. Maciejowska, 2009; 5. Schmidt, 2007; 6. Spessard, 1998.

Two programs were chosen because they fit the categories: Hyperchem and Chemlab. Both programs were chosen due to they do not need the internet, and can be installed locally. This is advantageous because of limited access to the Internet at school. Hyperchem was chosen because it could represent aspects of chemistry laboratory microscopically, easy installation, windows-based so it can be easily used by teachers. In addition, the facilities of Hyperchem calculations are fairly complete. The calculation can be performed at the various levels of calculations: molecular mechanics, semi-empiric, *ab initio*, density functional theory and post-*ab initio*. ChemLab was chosen due to it can represent the macroscopic aspects to bridge the wet laboratory practice. This program is also easy to use, easy to install and has the complete features for virtual practicum.

Some programs were eliminated due to a major flaw in installation, or difficult to use so they were not suitable for this project. Although NWChem and Gaussian relatively easy to install and have complete features, very complicated in the operation so that NWChem and Gaussian were eliminated. Although easy to install and use, ACD/ChemSketch only for visualization and cannot be used for calculating chemical system so that it was eliminated.

3.2. Chemistry Essential Topics

In order to obtain topics that are essential for chemical lab-based computing, the survey carried out on teachers. The survey results showed some of the main topics that need to be applied as the main topic chemistry lab work. Teachers suggest topics: atomstructures, periodic properties of the elements, acids and bases, physical and chemical properties of substances, molecular geometry, energy and thermodynamics and organic chemistry to be involved in the lab.

Once the essential topic is decided then the next step is to develop a practicum in accordance with software that has been previously based on these topics. It is found that topics such as the atomic structure, the periodic properties, molecular geometry, energy and thermodynamics and organic chemistry lab are suitable to be performed using Hyperchem. In contrast, topics such as acid-base and the physical and chemical properties of substances can easily do with ChemLab.

3.3. Teacher Motivation

The survey was also used to measure the level of motivation of teachers in implementing chemical lab. A total of 20 teachers were taken as a sample to determine the chemical lab work implementation and motivation before and after the introduction of computational chemistry technologies for chemical lab. The survey showed that nearly 85 % of teachers in Lombok Island did not carry out routine chemical lab. In contrast, survey showed that the motivation of teachers in conducting chemistry lab was categorized high (motivation score = 3.1 of interval 1-4). This contradiction may due to many obstacles as mentioned previously.

The introduction of computational chemistry as an alternative chemistry lab did not change the level of motivation of teachers for implementing chemistry lab in learning. The good news is our observation showed that the teachers at partner schoolshave started to carry out routine chemical lab. We believe soon it will be followed by other school in West Lombok district.

4. Conclusion

Chemistry lab-based computational chemistry can be an alternative solution for the chemistry lab at the high school. Practical chemistry-based computing has advantages such as efficiency of time, effort, and cost, minimize the hazards and waste practicum. Teachers have high motivation to carry out practical activities after the introduction of computational chemistry. Chemistry lab-based computing is very useful for teachers and students to optimize the learning process, especially in high school.

Acknowledgement

Many thanks to the Science and Technology for Society Program (IbM) RISTEKDIKTI 2016 for funding support. Chemistry Education Division, Faculty of Teacher Training and Science EducationMataramUniversity, headmasters and teachers of partner schools, the member of IbM team and students.

References

- [1] Coppola, B. P. (2008).SelamatDatang di Indonesia: Learning about chemistry and chemistry education in Indonesia. *Journal of Chemical Education*, 85(9), 1204-1209.
- [2] Fortenberry, R. C., McDonald, A. R., Shepherd, T. D., Kennedy, M., & Sherrill, C. D. 2015.PSI4Education: Computational Chemistry Labs Using Free Software, *ACS Symposium Series*, Vol. 1193, pp 85–98
- [3] Frisch, A. (Ed.). (2004). *Gaussian 03*.Gaussian.

- [4] Froimowitz, M. (1993).HyperChem: a software package for computational chemistry and molecular modeling. *Biotechniques*, 14(6), 1010-1013.
- [5] Jansen-van Vuuren, R. D., Buchanan, M. S., & McKenzie, R. H. 2013.Connecting resources for tertiary chemical education with scientists and students in developing countries.*Journal of Chemical Education*, 90(10), 1325-1332.
- [6] Maciejowska, I., & Bílek, M. 2009. 4.3 virtual environment on theoretical introduction and training of real experimentation. Interaction of real and virtual environment in early science education: tradition and challenges, 68.
- [7] Schmidt, J. R., & Polik, W. F. 2007.WebMO Pro, version 7.0; WebMO LLC: Holland, MI, USA, 2007.
- [8] Sendlinger, S. C. and Metz, C. R., 2010, Computational Chemistry for Chemistry Educators, *J. Comp. Sci. Edu*, 1, 1, 28-32
- [9] Spessard, G. O. 1998. ACD Labs/LogP dB 3.5 and ChemSketch 3.5.*Journal of chemical information and computer sciences*, 38(6), 1250-1253.
- [10] Ochterski, W, J., 2014, Using Computational Chemistry Activities to Promote Learning and Retention in a Secondary School General Chemistry Setting, *J. Chem. Edu*, 91 (6), 817-822
- [11] Valiev, M., Bylaska, E. J., Govind, N., Kowalski, K., Straatsma, T. P., Van Dam, H. J., ... & De Jong, W. A. (2010). NWChem: a comprehensive and scalable open-source solution for large scale molecular simulations. *Computer Physics Communications*, 181(9), 1477-1489.

The Application of Giving Various Dose of NPK Manure Toward Tobacco Crop (*Nicotiana Tabaccum L.*) in Lombok Island West Nusa Tenggara Island

Titin Sugianti^{*1}, Fitria Zulhaedar¹, Sudjudi¹

Assessment Institute for Agricultural Technology (BPTP) – Jl. Raya Peninjauan Narmada Lombok Barat Nusa
Tenggara Narmada

*titin_sugianti@yahoo.co.id

Abstract

Tobacco is one of plant which has high economic and commercial value. Tobacco is non food which is widely cultivated in around the world. The quality of tobaccos crop is depend on the availability of substance element where the tobacco is cultivated. The objective of this research is to identify the appropriate dose of various manure in increasing the tobacco quality and productivity. This research is conducting by using Complete Random Device consisting of seven treatments and repeated three times. Treatment planning of dose application on NPK manure toward tobacco crop is as follows. P1=control (NPK 12-15-20 600 Kg / ha+ZA 100 Kg / ha+KNO₃ 200 Kg / ha), P2=Npk 12-11-20 500 Kg / ha + ZA 100 Kg / ha, P3=Npk 12-11-20 600 Kg / ha + ZA 100 Kg / ha, P4=Npk 12-11-20 500 Kg / ha + ZA 100 Kg / ha+ZK 100 Kg / ha, P5=Npk 12-11-20 600 Kg / ha + ZA 100 Kg / ha+ZK 100 Kg / ha P6=Npk 12-11-20 500 Kg / ha + ZA 100 Kg / ha+ZK 200 Kg / ha, P7=Npk 12-11-20 600 Kg / ha + ZA 100 Kg / ha+ZK 200 Kg / ha. According to the result of dose application study of NPK manure toward tobacco crop concluded that: The giving of NPK manure with high dose do not show significant increasing of tobacco crop leaf amount and crop. Treatment of P1 with dose 600 Kg / ha NPK 12-15-20, 100 Kg / ha ZA and of KNO₃ 200 Kg / ha do not show significant differences compared to treatment of P2 which only using 500 Kg / ha NPK 12-11-20 and 100 Kg / ha ZA. Furthermore, according to result of analysis treatment of P1 yield heavy and wet weight run dry is higher than the treatment of P2 until P7. However, higher dry heavy and wet heavy do not positively significant toward heavy value of yielded orange oven. The treatment of P2 until P7 yields higher weight of orange than P1. This case happened due to the excessively of N element given in the plant media which made up the tobacco's leaves become black brown. As the result, it will decrease the economic value of tobacco crop.

Keywords: *Tobacco, Quality, Productivity, Manure.*

1. Introduction

Tobacco in Latin *Nicotiana tabacum L* is a plant that has a high economic value which is widely demand material and it is non food commercial plant widely cultivated in the world¹. Tobacco plants scattered throughout the archipelago and it has a variety of uses including as biopesticides, insecticides, preservatives for Petung bamboo, wound cleaning and mainly as a raw material for making cigarettes². Tobacco also has a significant role in the national economy through customs and taxation, employment and the double impact (multiplier effect) procurement and trading of tobacco³.

However, the development of agriculture in paddy fields and dry land often face a variety of constraints such as poor essential nutrients like N, P, K, Ca and the value of cation exchange (CEC) is low so that the nutrients easily separated and leached which together with

the increased nutrient toxic such as Al, Fe and Mn¹⁵. One of the efforts made by farmers to increase the production of tobacco is by fertilizing¹⁶.

The purpose of fertilization in the cultivation of tobacco plant is to meet the nutrients that plants need to obtain maximum results and to produce high quality of tobacco⁴. Therefore, the type and dose of fertilizer is crucial to the production and quality of tobacco produced. The needs of NPK macro nutrients for growing tobacco will determine the yield and quality of tobacco produced.

In other circumstances provided sufficient nutrients, nitrogen deficiency will lead to the accumulation of acetic acid to form the compound CH included carbohydrates, fats and pentose which can cause leaf tobacco and tasteless according⁵. However, excess nitrogen can cause decline in the quality of production where the production of oven blackish brown. The need for nutrients P and K in tobacco plants begin to look at the early stage of growth until the final result oven. According⁶ virginia tobacco requires high doses of phosphorus and potassium to be able to produce good quality, ie kerosoknya bright yellow.

To increase productivity and quality of the tobacco crop this then there must be technical, the dose and the right type of fertilizer to be used in the cultivation of tobacco. Besides a balanced fertilizer that specific location is directed to use with a variety of compound fertilizer formula that aims to avoid the inefficiencies of nutrients from fertilizer in locations that already have a high nutrient status.

Observing these conditions, the researchers intend to conduct a study of various doses of fertilizer application NPK in tobacco plants (*Nicotiana Tabaccum L.*). It is expected from this research note that the appropriate dosage of NPK fertilizer on productivity and quality of tobacco, so that the data and clear information about the size of the dose of NPK fertilizer on the growth and yield of Tobacco (*Nicotiana Tabacum L.*) is available.

2. Materials and Methods

The location for application testing dose of NPK On Tobacco plants (*Nicotiana Tabaccum L.*) was conducted in technical irrigated land in the village Rarang Terare East Lombok District of West Nusa Tenggara. The activities carried out in the growing season MK II. Tobacco cultivation is done in June to September 2016.

The materials used in this study is PVH09 virginia tobacco seeds, fertilizer NPK 12-11-20 Kebomas, ZA fertilizer, fertilizer KNO₃, ZK fertilizers and pesticides. The tools used are the plow, harrow, hoe, sickle, rope, hand sprayer, rulers, scales, sacks, tarpaulins and equipment oven.

The research studies dosage of NPK fertilizer application in tobacco plants are designed using a randomized block design (RAK), which consisted of 7 treatments, each conducted in the plot of a plot size of 4 x 5 m and each treatment was repeated 3 times. The design of the study treatment dosage of NPK fertilizer application in tobacco plants is as follows:

P1:NPK 12-15-20 600 kg/ha + ZA 100 kg/ha + KNO 3 200 kg/ha (control);

P2:NPK 12-11-20 500 kg/ha + ZA 100 kg/ha;

P3:NPK 12-11-20 600 kg/ha + ZA 100 kg/ha;

P4:NPK 12-11-20 500 kg/ha + ZA 100 kg/ha + ZK 100 kg/ha;

P5:NPK 12-11-20 600 kg/ha + ZA 100 kg/ha + ZK 100 kg/ha;

P6:NPK 12-11-20 500 kg/ha + ZA 100 kg/ha + ZK 200 kg/ha, and

P7:NPK 12-11-20 600 kg/ha + ZA 100 kg/ha + ZK 200 kg/ha

The working procedures were performed in accordance with the procedures tobacco cultivation PT. Indonesia Dwi Sembilan which is one of the companies engaged in tobacco which is located in District Sikur East Lombok West Nusa Tenggara and guide books virginia tobacco cultivation for tobacco cultivation implement good practices (Good Tobacco

Practices / GTP) in East Java.

The determining the location is based on the uniformity testing overlay planting area which represents, flat, irrigated semi-technical engineering, open (not shaded), free of the effects of flooding so it is easy to access and remove excess water and easily monitored. Work on the land begins to clean up the remnants of plant like grass and others. Land unloaded with a tractor or hoe, followed by the manufacturing process got around size 40 x 40 cm and got control of 35 x 35 cm. Map plots the treatment used is 4x5 m and created ridges with lebarxpanjang size 0,60x5 m and a height of 30-35 cm; so that in each plot consisted of four treatment plots mounds. Planting is done by planting the seeds scraped who have been sowing before the seedbed seedbed with the criteria of seedlings 40-45 days, 10-15 cm height, leaf number 4-5 sheets, not thin, good rooting and disease free. Manufacture planting hole using a hoe with a distance of 110 cm between rows and in rows 50 cm, planted 1 perlubang crop planting. Before planting the leaves of plants cut to one third that aims to reduce the evaporation of the tobacco plant seeds are planted.

Fertilization of tobacco plants done 3 times, namely: first fertilization performed at the age of 7-10 plants HST (days after planting) for NPK fertilizer at a distance of 5 cm from the plants as a treatment. Second fertilization performed at the age of 14-20 plants HST to ZA with pouring system at a distance of 5 cm from the plant. Fertilization is done at age three plants for fertilizers KNO₃ 25-30 HST to control and ZK on treatment is by putting fertilizer at a depth of 15-20 cm with a distance of \pm 25 cm from the plant, giving done by hoeing the soil around the plant canopy as deep as \pm 25 cm from the soil surface.

The activity maintenance is watering, weeding, shady, pruning or topping, pest and disease control. When the provision of water and the amount of water given, in connection with growth towards the establishment of optimal quality, an outline is as follows⁷: a. When planting, the soil is required for immediate moisturization roots if used seed paste scraped from the embankment, b. When the soil is not sufficient water, with spray irrigation is done by pouring water 0.5-1.0 l liter/cropping and given to the base of the plant until the age of 10-20 days, depending on the condition of the plants, watering is done in the morning and afternoon. After the age of the plant is strong enough only watered once a day.

Watering by immersing the ridges there are three stages: the first irrigation with water $\frac{3}{4}$ height of ridges to the growth stage and watering II and III water level $\frac{1}{4}$ - $\frac{1}{2}$ to stage maintain the quality of tobacco. Trimming (topping) is an activity cut or dispose of the plants and carried out in the phase button stage (flower has not bloomed / cob flowers appear. Mewiwil (suckering) is to remove the axillary buds (axillary-bud) that grow increased as a result of actions prunings. Generally clipping the better is to throw leaves unproductive shoots that could not grow anymore. Control of pests and diseases of plants is done according to the conditions in the field.

Observations included the analysis of soil chemical properties beginning and end, ie agronomic data collection of plant height and number of leaves done at age 0 hst, 40 hst and 70 hst. Measurement of plant leaf fresh weight carried on each harvest based on the position of the leaves. Measurement of leaf dry weight of plants is done after the process of oven. The number of plants observed in each treatment is 10 plants, were randomized to each treatment. Harvest activities in tobacco plants by means of picking the leaves are characterized by leaves yellowish green or yellow has been ahead. The flush in one harvest generally ranges from 2-3 sheet and can be picked 1 time a week. In the harvest season can last 7-8 times quotes for 7- 8 weeks. To know the difference among the treatments in this test, all the agronomic data has been collected and analyzed using ANOVA followed by LSD test at 5% level.

3. Results and Discussion

3.1 Characteristics of Soil Testing

The test site is irrigated land with soil type Inceptisol technical and textured sandy loam with a depth of 20-25 cm soil solum and bertopografi flat with a height of 125 meters above sea level, is a potential area for tobacco plants were planted after the rainy season rice planting. Based on the results of the initial soil analysis and soil analysis results late in each treatment and testing conducted at the Laboratory Testing BPTP NTB presented in Tabel 1.

Table 1. Results of Soil Analysis before and after the study of the application of various doses of NPK fertilizer in tobacco plants (*Nicotiana Tabaccum L.*)

Treatment	Parameter of Analysis					
	N (%)	Nutrient Status	P (ppm)	Nutrient Status	K (ppm)	Nutrient Status
First Analysis	0,16	Low	15,24	Very high	303,54	Very high
Second Analysis						Very high
P 1	0,16	Low	17,73	Very high	344,27	Very high
P 2	0,13	Low	19,77	Very high	347,02	Very high
P 3	0,14	Low	15,24	Very high	353,60	Very high
P 4	0,11	Low	13,07	Very high	335,49	Very high
P 5	0,12	Low	13,02	Very high	374,81	Very high
P 6	0,11	Low	13,53	Very high	326,18	Very high
P 7	0,12	Low	13,83	Very high	334,37	Very high

From the results of the soil analysis carried out showed that the initial ground before the test process applications contained low N value, while the value of the content of P and K available is very high. After making the test process according to the dose of fertilizer application in the treatment of each plot testing shows that the value of the dignity of N, P and K are contained in the same land that is sequentially lower N, P and K are very high. Soil Nutrient Status criteria in Table 2 are set based on the assessment of soil nutrient status Technical Guide 2nd edition Chemical Analysis Soil, Plants, Fertilizer Water and Soil Research Institute in 2009.

Kriterian ratings soil analysis results indicate that the number N is given the maximum absorbed by tobacco plants so that the dosage of N quite appropriate doses given at each treatment. While the value of P and K are still very high indicate a need for dose reduction element K is given because it is basically the amount of element content of P and K are available on the ground is already very high. It is also proved that for the growth of tobacco plants of the dosage of nutrients P and K are contained in NPK fertilizer which has 11% P and 20% K is sufficient to meet the nutrient needs of P and K on the growth of tobacco plants.

3.2. The Growth of Tobacco Plant

The growth of tobacco plants characterized by a high increase in the number of plants and plant leaves. Based on the statistical analysis of data obtained from various plant growth are presented based on the observation of parameters. Plant height and number of leaves is the variable response of plant growth. The results of test analysis fertilizer application on plant height and number of leaves of tobacco plants are presented in Table 2.

Table 2. Result of plant high and number of leaf the tobacco by several dosage of NPK fertilizer

Treatment	Plant high			Number of leaf		
	0 dap	40 dap	70 dap	0 dap	40 dap	70 dap
P 1	15	75,1	110,5	5	15 ab	18.77 a
P 2	15	81,9	115	5	15.17ab	20.27 b
P 3	15	79,7	118,5	5	15.67 b	19.7 ab
P 4	15	77	110,5	5	14.83 a	18.17 a
P 5	15	77,1	110,7	5	14.33 a	19.2 ab
P 6	15	80,2	113,4	5	15.03ab	19.87ab
P 7	15	84,8	118,7	5	15.5 b	20.33 b
	Ns	ns	ns	ns		

* The average value in the same column follows with the same alphabet is showing indifferent significant on LSD test at 5% standard

Statistically, the high of tobacco plant based treatments tested showed no significant differences in measurement 0 hst, 40 hst and 70 hst. These results indicate the dosage of NPK fertilizer, ZA, and KNO₃ which is a fertilizer that contains nutrients N is an element needed for vegetative growth of the plants one plant height, did not have a significant influence on the response of the tobacco plant height at each age observations.

Test Results Fertilizer application is in accordance with the results of research conducted by the Madura tobacco^{8,9} as well as research PT. BAT Indonesia in Bali¹⁰ which states that increasing doses of nitrogen fertilizer on tobacco no significant effect on plant height. Nitrogen role as the main element to form chlorophyll and photosynthesis result leaves more focused on leaf size than the plant height and stem diameter. This is due to the active growth of plants is dominated by the leaves that require high nitrogen, while the stem growth area is limited to the cambium and the end of the shoots of plants¹¹. According¹² nutrient nitrogen also affect plant growth that makes plants green, leaf and stem growth, and makes plants more succulent.

Leaves are organs of plants synthesizing a food for the needs of plants as well as food reserves. The leaves have a role in the process of chlorophyll photosynthesis. The more the number of leaves produced, then the place for the process of photosynthesis more so as a result of more photosynthesis. Based on the analysis of tobacco plants showed on observations 0 dap there is no significant difference, it is because the seeds used uniform has 5 leaves. In observation of the number of leaves of tobacco plants at the age of 40 and 70 dap there are significant differences. At the peak of growth, namely the observation of the third age of 70 hst showed the highest number of leaves in the treatment of P2 and P7 with a value of 20.27 and 20.33 bila sequentially compared with the amount of leaves in the treatment of farmers, namely P1 number of leaves produced only 18.77.

This shows an increase in the number of doses given does not give a real difference to the number of leaves. This is consistent with the results of research conducted by⁹ that an increase in dose or dose of fertilizer did not show significant differences in the number of leaves. It is also in line with¹³ where a lot of fertilizer does not always give a good advantage for the plant. Although there are differences in the number of leaves on the treatment dose tested N but the effect is not significant on the number of leaves. The number of leaves can also be influenced by genetic factors¹⁴.

3.3 Tobacco Plant Productivity

The response variable productivity of tobacco plants observed wet weight, dry weight, heavy orange oven, oven heavy brown and orange and cokat percentage yield. The results of the analysis of various tobacco crop productivity variables are presented in the following tables.

The response variable wet weight includes the weight of the wet leaves of the tobacco plant. Based on the research applications of various doses of NPK fertilizer in tobacco plants (*Nicotiana Tabaccum L.*) to the weight of the wet leaves of tobacco plants is presented in Figure 1, the graph shows that the total wet weight wet weight in treatment P1 has a total value of wet weight is high at 19 842 kg / ha compared to treatment of P2-P7 range of values ranging between 15 202 kg/ha - 16 172 kg/ha. According to⁷ administration with high-dose nitrogen can convert carbohydrates produced by photosynthesis into protein so it will add width, length, and number of leaves. So that the effect of high N elements in treatment P1 positive effect on the value of the wet weight of tobacco leaf produced.

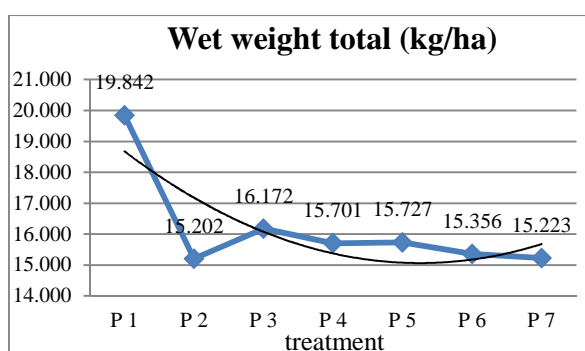

Figure 1. Total of wet weight (kg/ha)

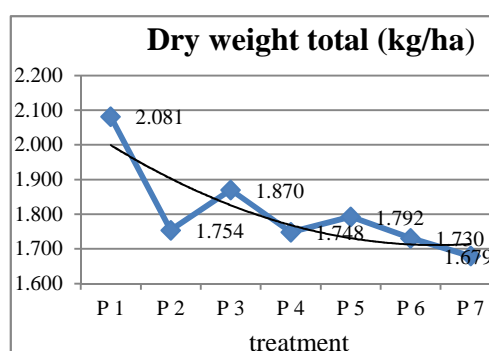

Figure 2. Total of dry weight (kg/ha)

Dry weight response variables derived from process pengovenan include dry weight of the leaves of tobacco plants. Based on analysis of the study of application of various doses of NPK fertilizer in tobacco plants (*Nicotiana Tabaccum L.*) to dry weight of leaf tobacco plants are presented in Figure 2, shows that the total dry weight graph result pengovenan higher treatment compared to treatment P1 P2-P7 Total weight dry oven treatment results P1 worth of 2,081 kg/ha, while the value range of dry weight P2 to P7 treatment ranged from 1,679 kg/ha to 1,870 kg/ha. The total value of the results of oven dry weight compared to the total value posisif initial wet weight of the tobacco leaves before the oven, in order to obtain the dry weight of leaf tobacco would be higher than P1 P2 -P7 treatment which has a total wet weight is lower.

Although the dry weight of P1 higher treatment but has not been disaggregated to quality oven dried classified into dry weight oven dry weight oven brown and orange. Where classification orange oven provides ekomis value much higher than the oven brown.

The response variable heavy oven orange and brown is obtained from the leaves of the tobacco plant pengovenan. Graphs total weight of oven orange and brown are presented in Figure 3.

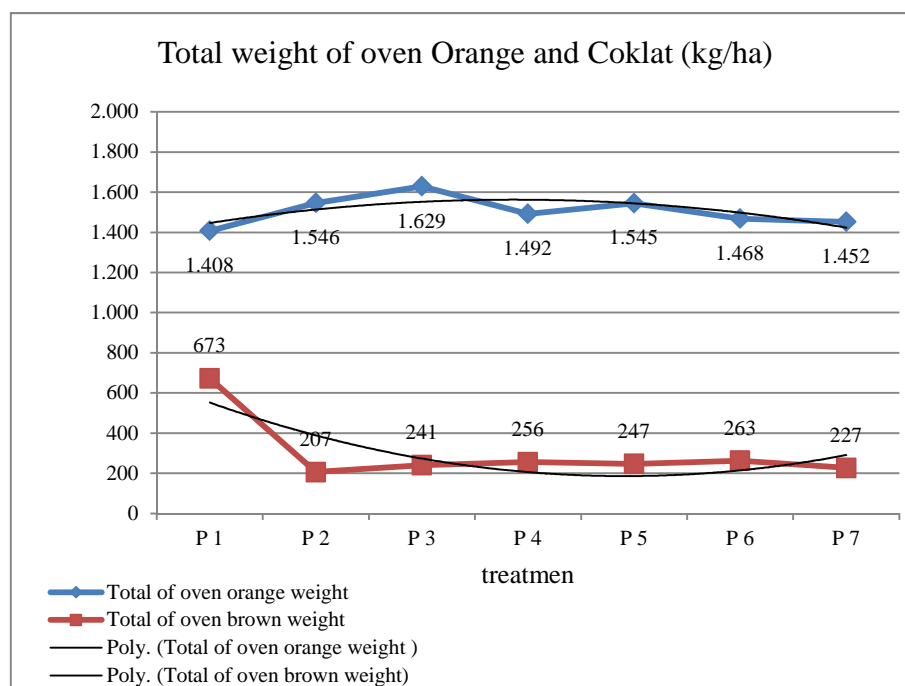

Figure 3. Total weight of oven orange and brown (kg/ha)

Based on analysis of the study of application of various doses of NPK fertilizer in tobacco plants (*Nicotiana Tabaccum L.*) to heavy oven orange and brown leaves of tobacco plants presented in Figure 5. Total weight of oven orange shows the results of treatment P1 showed a lower weight orange oven with 1408 results kg/ha but produces heavy oven chocolate high as 673 kg/ha. In the treatment of P2 -P7 obtained top results in the treatment dosages of P3 with a total weight of 1,629 kg orange oven/ha with oven brown weight 241 kg/ha. This shows that the use of fertilizer dose of 700 kg/ha (600 kg/ha of NPK 12-11-20 plus 100 kg/ha ZA) has high yields of the number of orange oven and reduce the weight of the oven chocolate. To a certain extent increased doses of nitrogen will increase the width of leaves and production, but this increase will actually reduce production. It terjadikarena increasingly thin leaves, causing tobacco plants produce *krosokan* (the last leaf) become brittle blackish brown, thick berbodi with heaviness and leaf tobacco would be difficult to cook because chlorophyll is stable and difficult overhauled during penguningan phase leaves. According to the⁶, when there is excess nitrogen will cause more dominant SINTESI protein so that the vegetative growth phase is longer, delayed flowering and ripening leaves. But on the cultivation of tobacco plants vegetative growth dikendaki not long, it will cause the plants thrive with high water absorption, so it will eventually affect the oven and the desired end result.

4. Conclusion

Based on the results of the study dosage of NPK fertilizer application in tobacco plants can be drawn some conclusions, namely: NPK fertilizer with high doses did not show any significant differences on plant height and number of leaves of tobacco plants. Treatment of P1 with a dose of 600 kg/ha of NPK 12-15-20, 100 kg/ha ZA and KNO₃ 200 kg/ha did not have a significant effect compared to P2 treatment using only 500 kg/ha NPK 12-11-20 and 100 kg/ ha ZA. Based on the analysis of treatment P1 produce heavy wet and dry weight were higher compared to treatment P2 to P7. However, the high weight of the wet and dry weight

of no positive value to the value of the resulting orange oven weight. Treatment of P2 to P7 produce heavy orange higher than P1. This is caused by an excess of N given where the excess of the nutrient content of N can cause *krosokan* become brittle, blackish brown, and ultimately reduce the economic value of farming.

5. Suggestion

Every one who demand accurate informsi dosage of NPK fertilizer on tobacco plants should conduct a study dosage of NPK fertilizer application on the season and the different areas in order to provide accurate information about the proper dosage for a particular tobacco cultivation systems for growers of tobacco plants.

References

- [1] P. Maris, A. Tarno and A. Afandi, 2014. *Effectiveness of Using Biological Fertilizer Mycorhyza (Glanus spp) for Control of Root Knot Nematodes (meloidogyne javanica) in Tobacco (Nicotiana Tabaccum L).* HPT Journal 2 (4), December 2014. ISSN 2338.4336
- [2] Sardi, 2016. *Effectiveness Fertilization in Tobacco Plants.* Scientific Comunity.
- [3] Kurniawan, B.A, S. Fajriani, Ariffin, 2014. *Effect of Total Water Response Against Tobacco (Nicotiana Tabaccum L.) Plant Growth and Yield.* Journal of Palnt Production 2 (1), January 2014: pp. 59-64 .
- [4] Djajadi, 2008. *Effect of Compound Fertilizer Againts Tobacco Yeild and Quality of Virginia in East Java Bondowoso.* Journal of Littri 14 (3), September 2008: pp. 95-100. ISSN 0853-8212.
- [5] Murdiyati, 1997. *Nutrient and Fertilization on Virginia Tobacco. Book 1 Monograf Balittas Virginia Tobacco.* Research Centers for Sweetener and Fiber Plants. Agricultural Research and Development Insitute. Agricultural Departement.
- [6] PT. Indonesia Dwi Sembilan, 2010. *Good Agricultural Practical (GAP) Hand Book.*
- [7] Hakim. 1986. *The Basics of Soil Science.* Universitas Lampung Press. Bandar Lampung.
- [8] Rachman, A dan A, S. Murdiyati. 1987. *Dose Effect of N and P Fertilizer on the Production and Quality of Madura Tobacco on Soil Aluvial.* BPPT, Malang 2 (1-2) : pp. 1-9
- [9] Febrian. 2011. *Effect of Nitrogen Fertilizer on the Gworth and Productivity of Tobacco (Nicotiana Tabacum L.) Prancak Varieties in a Population Density of 36.000/ha in Pamekasan Regency, East Java.* Departement of Biology, Faculty of Mathematics and Natural Sciences. Insitute of Technology.
- [10] Rachman, A. dan Djajadi. 1991. *Dose Effect of N and K Fertilizer to the properties agronomist and Chemical Composition of Tobacco Leaves Temanggung in paddy field..* Tobacco and Fiber Research (6) 1, 1991 : pp. 21-30
- [11] Riyn. 2009. *Recycling Carbon, Nitrogen and Other Hara.* [http :// riynmultiply.com](http://riynmultiply.com) accessed on Oktober 19, 2016.
- [12] Djamaan, D. 2006. *Application of Nitrogen (Urea) on the Growth and Yield of Lettuce (Lactusa sativa L.).* Assessment Institute for Agricultural Technology Sumatera Barat.
- [13] Istiana, H. 2007. *Nitrogen Fertilizer Applicatio Method and it's Effect on Madura Tobacco Plants.* Bulletin of Agricultural Engineering 12 (2). Crop Research Institute for Tobacco and Fiber, Malang.
- [14] Sudjudi, 2014. *Final Report Tetsting Effectiveness of NPK Phonska Plus 0,2% Zn on Rice Plant.* Assessment Institute for Agricultural Technology Nusa Tenggara Barat.
- [15] Sardi, 2016. *Efectiveness of Fertilization on Tobacco Plant.* Scientific Community.

The Optical Properties of SnO₂ Thin Layer With Dopan Zinc Using Solgel Technique

Aris Doyan^{1,a)}, Susilawati^{1,b)}, Yolanita Septiana^{1,c)}

Master of Science education, Post Graduate Mataram University
Lombok Indonesia¹

e-mail : ^{a)}arisdoyan@yahoo.co.id, ^{b)}Susilawatihambali@yahoo.co.id,
^{c)}ollayolanitaseptiana@yahoo.com,

Abstract

A thin layer of a material that is grown on the substrate surface with a size up to the nanometer scale. This study aims to determine the optical properties of SnO₂ thin film by doping Zn using sol-gel method. Variations in the concentration of the sol used 0.1, 0.2, and 0.3 M and Zn doping concentration of 0, 5, 10 and 20 % at 550°C annealing temperature. The characterization using UV - Vis Spectrophotometer, indicating reduced transmittance after being given dopants, for their absorption is shifted to shorter wavelengths, causing the energy band gap decreases with increasing sol concentration and doping Zn.

Keywords : *Optical properties, thin film, SnO₂, Zn, sol gel.*

1. Introduction

The development of science and technology more rapidly led to more varied innovations in various fields, especially electronics. Businesses that need to be done so as not to depend on other countries by making the independent Indonesian state so as to create an electronic device and be able to compete in the world of technology. An electronic device can be derived from a semiconductor material. Semiconductors are solid materials which have an energy band gap of 0.5 - 5.0 eV (between conductor and insulator) and made in the form of pellets, a layer of thick and thin layers. Electronic device may use a semiconductor material because it can alter the characteristics of a material such as optical properties, crystal structure, morphology and composition contained in the material.

Thin film technology is the development in the field of solid material that is widely used to achieve a thickness of 1µm [1]. Early development of the thin layer in 1852 by Groove with the development of the materials use, the method, as well as treatment given in a thin layer. It is became the basis of further research to develop the conducting transparent oxide, gas sensors, transistors and other electronic devices. Material that can be used in the synthesis of a thin layer of the material that has properties as a metal oxide material such as ZnO, SnO₂, TiO₂, In₂O₃, WO₃, ITO and many other materials. ZnO and TiO₂ is widely used because it shows good flexibility in the methods of synthesis and morphology of particles produced [2]. But has the disadvantage at the time of coating and stability are low in chemical processes and can affect the resistivity of the material of electronics. As with the doping material indium tin oxide absorption, transmittance decreases [3]. Absorption occurs because of the clumping of solute in a solution by the surface of the absorbent substance that forms a bond between the absorber. Absorption occurs due to the presence of compounds that undergo electronic transitions when exposed to light from a source. The transition is usually caused by

electron transitions between electronic states in atoms or material. Electron transitions between energy levels in the atoms outside the great mass also involve ultraviolet energy. This corresponded to a total energy of wavelengths from ultraviolet to visible light even to the near infrared. Absorption of ultraviolet to visible light energy transition involves a fairly high (above 1 eV)[4]. Based on the description above, the authors analyze the characteristics of SnO₂ layers without doping, and given various concentration sol, Zn doping. Variations sol and doping concentration of Zn to get a variation of the optical properties of a thin layer of SnO₂ through absorption and transmittance testing include SnO₂ layer by doping Zn tested with UV-Vis spectrophotometer.

2. Materials And Methods

Thin layer sample preparation method used is the sol-gel spin coating deposition. The basic ingredients used in this study as C₂H₅OH, SnCl₂.2H₂O, and ZnCl₂ in the form of a powder with a purity of 99.99% with heating 550oC. After the sample is finished in the heat, further samples SnO₂ thin layer with Zn doping variation tested by UV-Vis Mini 1240SA (Shimadzu) with a wavelength of ultraviolet light to visible light through (300-800 nm) to determine the value of the transmittance and absobansi and analyze the band gap energy.

3. Result And Discussion

Testing samples of SnO₂ thin layer with a metal doping Zn conducted to determine the transmittance, absorption and energy band gap on each individual sample. In SnO₂ thin layer transmittance spectrum of 0.2 and 0.3 M showed a regular decrease with the addition of doping given Zn grown on the surface of the glass substrate. There are two parts of the first part of the curve transmittance 350 nm – 1500 nm and transmittance is between 80% and on the 290 nm – 350 nm which is the absorption area, the transmittance decreases (falls) [3]. The test results UV-Vis spectrophotometer can be seen in Figure 1 below.

Absorption of SnO₂ thin layer using metal doping Zn pada 0,1 M; 0.2 M; and 0.3M with doping concentration variation of 0%, 5%, 10% and 20% can be seen in Figure 2 below:

The energy band gap in the semiconductor optical analysis using Tauc equation [2], which is a relation between the plot that shows the linearity, where extrapolation may be used in calculating the energy gap. Values energy band gap in the sol concentration of 0.1 M, 0.2 M and 0.3 M showed a significant decrease. This is due to the influence of density is changed in a thin layer, change the size of the crystal grains in thin layers and their quantum size effects [6]. Energy gap extrapolating results is the value obtained in Table 1.

Table 1. Energy band gap with different concentrations and varying concentrations of metal doping Zn

concentration sol	A thin layer sample	Energy gap
0,3 M	Pure SnO ₂	3.291
	SnO ₂ + Zn 5%	3.179
	SnO ₂ + Zn 10%	3.177
	SnO ₂ + Zn 20%	2.804
0,2 M	Pure SnO ₂	3.292
	SnO ₂ + Zn 5%	3.362
	SnO ₂ + Zn 10%	2,000
	SnO ₂ + Zn 20%	2.800
0,1 M	Pure SnO ₂	3.471
	SnO ₂ + Zn 5%	2.372
	SnO ₂ + Zn 10%	2.254
	SnO ₂ + Zn 20%	1.937

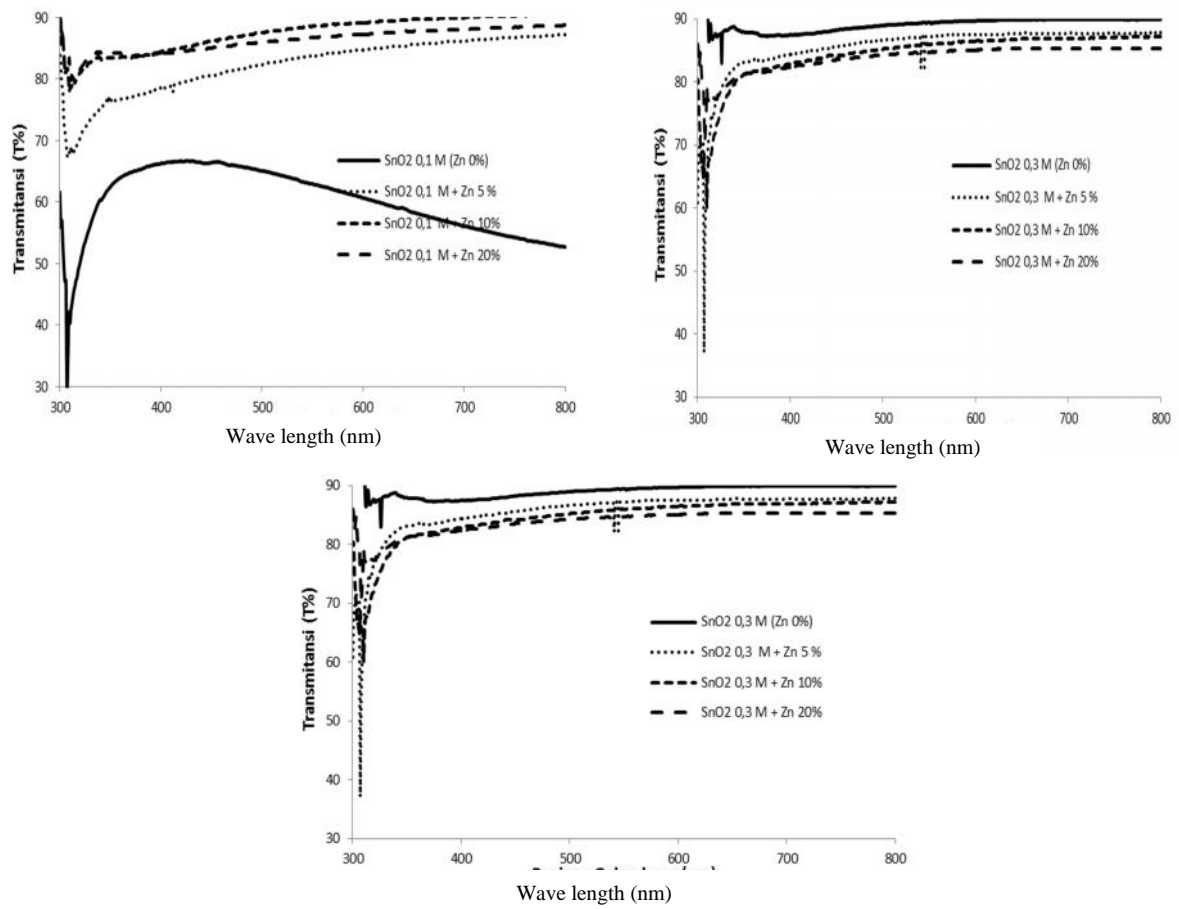

Figure 1. Graph transmittance with a concentration of 0.1 M sol (a), 0.2 M (b) and 0.3 M (c) with doping variation of 0%, 5%, 10% and 20%.

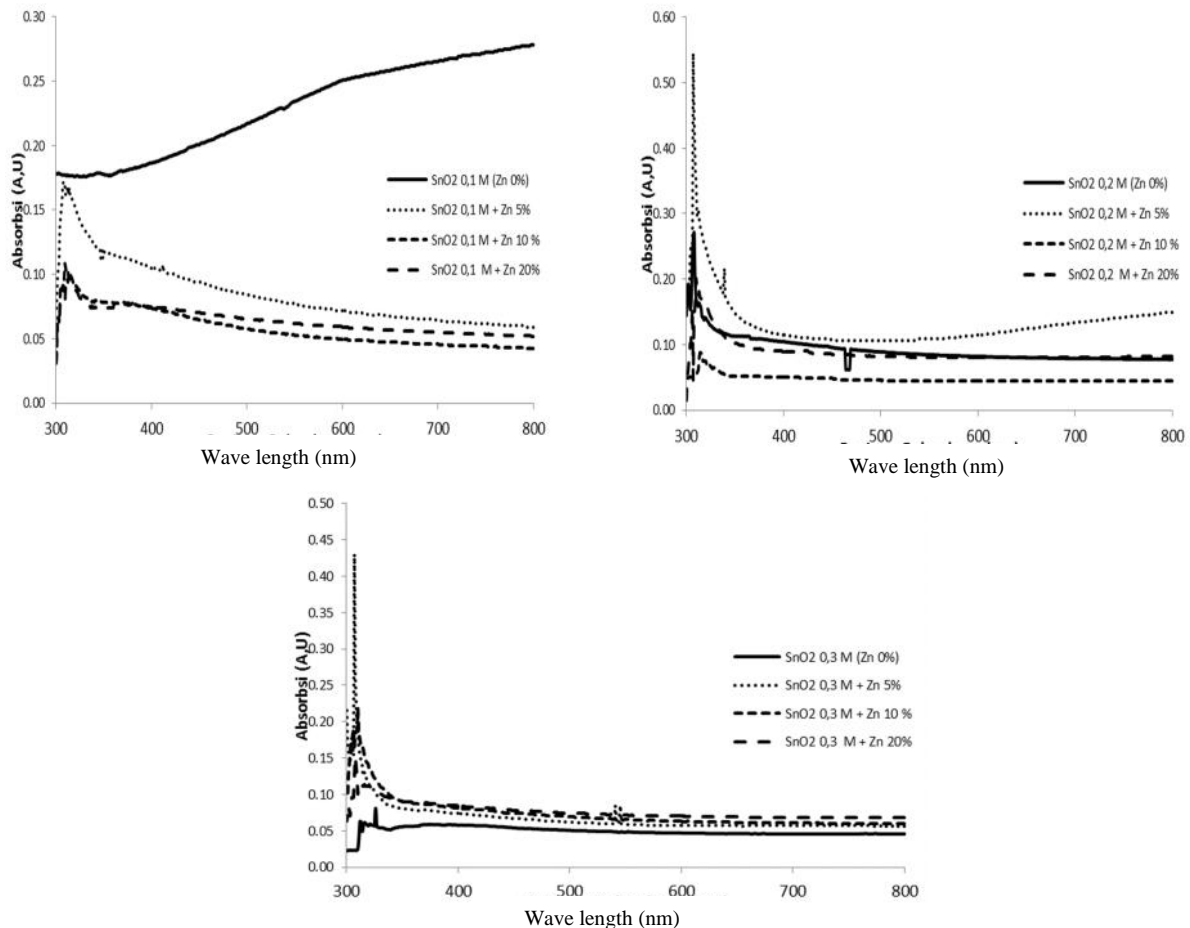

Figure 2. Absorption chart with sol concentration of 0.1 M (a), 0.2 M (b) and 0.3 M (c) with doping variation of 0%, 5%, 10% and 20%.

4. Conclusion

The optical properties of SnO₂ thin layer with a transmittance and energy band gap decreases with given variations of metal Zn doping concentration of 0%, 5%, 10% and 20%, but absorption increases with the doping given variation. In theory indicates the sample is a semiconductor

References

- [1] A. Ayeshmariam, 2013. *Synthesis, Structural and Optical Characterizations of SnO₂ Nanoparticles*. *Journal on Photonics and Spintronics*. Vol 2 No 2 May 2013.
- [2] A.N.Naje, A.S. Norry, and A.M. Suhail, 2013. *Preparation and Characterization of SnO₂ nanoparticles*. *International Journal of Innovative Research in Science, Engineering and Technology* (An ISO 3297 :2007 Certified Organization) Vol 2, issue 12, December 2013.
- [3] A.R. Razeghizadeh, V. Rafee, and L.Zalaghi, 2015. *Effects of Changes Sol Concentration on The Structural and Optical Properties of SnO₂ Nanoparticle by The Sol-Gel Technique*. (Online: <http://arxiv.org/abs/1502.00219v1>).
- [4] P.Gupta, 2013. *Synthesis and Characterization of Pure and Zn-Doped SnO₂ Nanopowders*. *International Journal of Modern Physics : Conference Series* Vol 22 (2013) 452-457.
- [5] A. Farooq, and M.Kamran, 2012. *Effect of Sol Concentration on Structural and Optical Behavior of ZnO Thin Films Prepared by Sol-Gel Spin Coating*. *International Journal of Applied Physics and Mathematics*, Vol. 2, No. November 6, 2012.
- [6] M.Shaban, G.F.Attia, A.Basyooni, and H. Hamdy, 2015. *Morphological and Structure Properties of Spin coated Tin Oxide Thin Film*. *International Engineering and Advanced Research Technology (IJEART)* Volume-1, Issue-3, September 7, 2015.

The Electrical Properties of Barium Hexaferrite Nanopowders Using Co-Precipitation Method

Susilawati¹, Aris Doyan^{1*}

¹Magister Science, Post Graduate of Mataram University, Mataram, Indonesia

* Email: susilawatihambali@yahoo.co.id and arisdoyan@yahoo.co.id

Abstract

Barium hexaferrite BaFe₁₂O₁₉ powders have been synthesized using co-precipitation method and examined LCR meter. Co-Zn were substituted barium ferrite nanocrystalline particles BaFe_{12-2x}Co_xZn_xO₁₉ with (0 < x < 1) were prepared by co-precipitation method, and their electrical properties and their temperature dependencies were studied. The ac conductivity measurements were performed within a temperature range 400-800⁰C. The ac conductivity showed a linear relation with the frequency power law for BaFe₁₂O₁₉. For all the samples it is observed that electrical conductivity is small in the lower frequency region and increases for higher frequencies and conductivity increases with temperature. It decreases with increasing temperature, indicating that the heterogeneous structures increase. Cationic substitution in M-type hexaferrites is considered to be an important tool for modification of their electrical properties. The results of the study demonstrate a relationship between the modulation of electrical properties of substituted ferrites and nature of cations and their lattice site occupancy. The effect of variation of composition, frequency and temperature on conductivity has been carried out. The ac conductivity increased with temperature showing semiconductor like nature of the samples..

Keywords: Barium Hexaferrite, electrical properties, co-precipitation, nanopowder

1. Introduction

Barium M-Hexaferrites (BAM) has a hexagonal molecular structure (BaFe₁₂O₁₉) is one material that attracts many researchers because it has electricity and magnetism parameter high. BAM has a high saturation magnetization (72 emu / g) [1], terrain large coercivity (6700 Oe) [2], and a high Curie temperature (502 ° C) [3]. This causes these materials have wide applications such as: as an electromagnetic wave absorbing material, memory devices, microwave devices, and recording media with high density [4-5]. As the wave absorbing material, BAM must have electrical properties such as high electrical resistivity, dielectric lost and magnetic lost low [6], while for applications as a storage medium or memory required a high density [7]. To produce a high density, the resulting crystals must be sized nano and uniform distribution so this is one of the challenges in research.

The other interesting thing of BaM is the nature of electricity and magnetism can be modified according to the application required by the researcher. Engineering can be done by way of substitution or doping. Some researchers have tried replacing the iron (Fe) with transition metal ions of the elements that have similar ionic radii such as La, Ti, Mn, Co, Ni and Zn [8-11]. This research will be conducted ion substitution with Co-Zn alloys. Selection of doping is based on previous research, namely: electrical conductivity increases with increasing temperature and the concentration of Zn ions [12] and the dielectric constant is largely influenced by the concentration of Co ions that decrease with increased frequency in a wide variety of temperature [13]. Frequency and temperature influence on the electrical

properties of a material would provide information about the charge transfer mechanism and dielectric properties of the materials. Therefore, this study aimed to investigate the influence of the frequency of the electrical properties of Bam on a wide variety of Co-Zn ion concentration and calcinations temperature variations.

In the synthesis of Bam there are several commonly used methods such as solid state reaction [14], solution combustion method [15], sol-gel [16-17], and co-precipitation [18,19]. The preferred method is co-precipitation research because it is easy to control the chemical composition and size of the crystals produced [20].

2. Materials and Methods

2.1. The Synthesis of Barium Powder Process M-Hexaferrit ($\text{BaFe}_{12-2x}\text{Co}_x\text{Zn}_x\text{O}_{19}$)

The materials used in this study for the synthesis of barium M-hexaferrit $\text{BaFe}_{12-2x}\text{Co}_x\text{Zn}_x\text{O}_{19}$ are: Barium Carbonate Powder (BaCO_3) with $M = 197.34 \text{ g/mol}$, Iron (III) Chloride Hexahydrate ($\text{FeCl}_3 \cdot 6\text{H}_2\text{O}$) as the base material With $M = 270.33 \text{ g/mol}$, and CoCl_2 powder and Zn proanalysis (PA) as a doping material with variations in the value of $x = 0; 0.2; 0.4; 0.6; 0.8; 1$. Synthesis of barium M-hexaferrit $\text{BaFe}_{12-2x}\text{Co}_x\text{Zn}_x\text{O}_{19}$ performed by co-precipitation method comprising: Powder Barium carbonate (BaCO_3) solution dissolved in HCl (0.1N), heated to a temperature of about 800°C with hot plate and stirred using a magnetic stirrer for approximately 2 hours until the powder dissolved and the solution is clear white. Crystal Iron (III) chloride Hexahydrate ($\text{FeCl}_3 \cdot 6\text{H}_2\text{O}$) diluted with distilled water, stirred with a magnetic stirrer without heating to obtain a solution with a blackish brown color. Zn powder was dissolved in HCl (0.1 N) and the CoCl_2 powder. The second solution diluted with distilled water acts as doping. The above three solutions are mixed and stirred with a magnetic stirrer until it becomes homogeneous (black and brown), without settling heated then added a solution of NH_4OH (25%), to obtain a precipitate with high homogeneity (dark brown). After a few minutes of samples ranging look no deposits, after which the precipitate is filtered by using a filter paper and washed with distilled water up to 10 times until reached state neutral or reached $\text{pH} = 7$. After the sample is deposited so as to achieve a normal ph level, then the sample crushed so that we will get a fine powder samples.

3. Results and Discussion.

For all the samples BaM with doping Co dan Co-Zn are observed that conductivity is small in the lower frequency region and increases for higher frequencies (Fig. 1(b) and 2 (b)). The electrical conductivity increases with temperature as shown in Fig. 1(b), 2(a) and 2(b). Therefore, the iron oxides are generally termed as 'semiconductors'. The lattice vibrations increase with temperature, giving rise to higher probability of the hopping of electrons at the octahedral sites, leading to enhanced mobility of charge carriers and hence the conductivity [12].

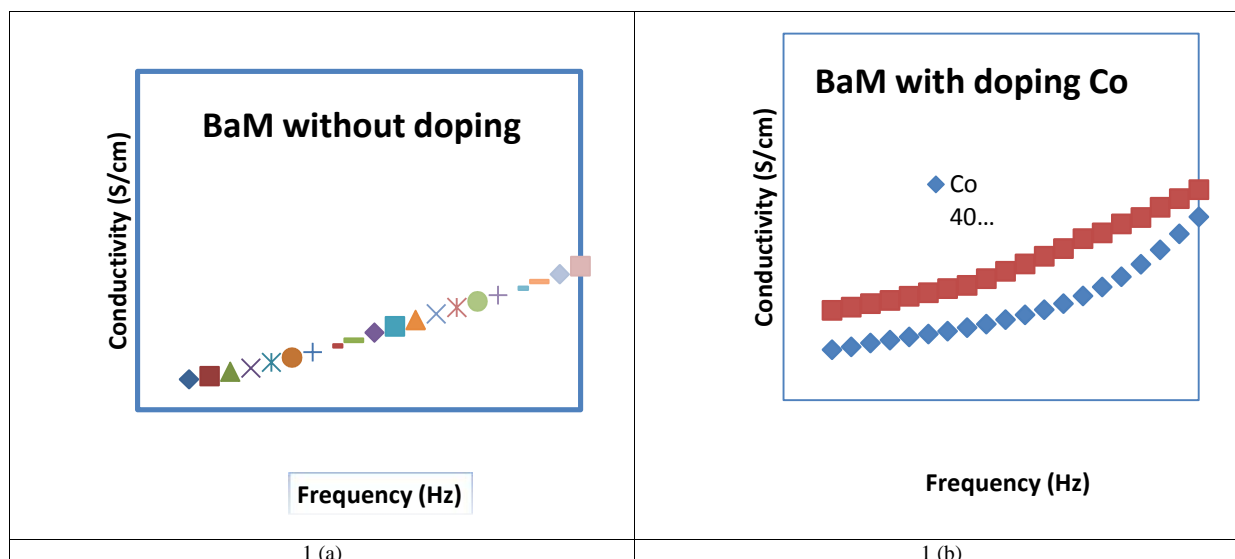

Figure 1. (a) log conductivity versus log frequency for BaM without doping and (b) log conductivity versus log frequency for BaM with doping Co

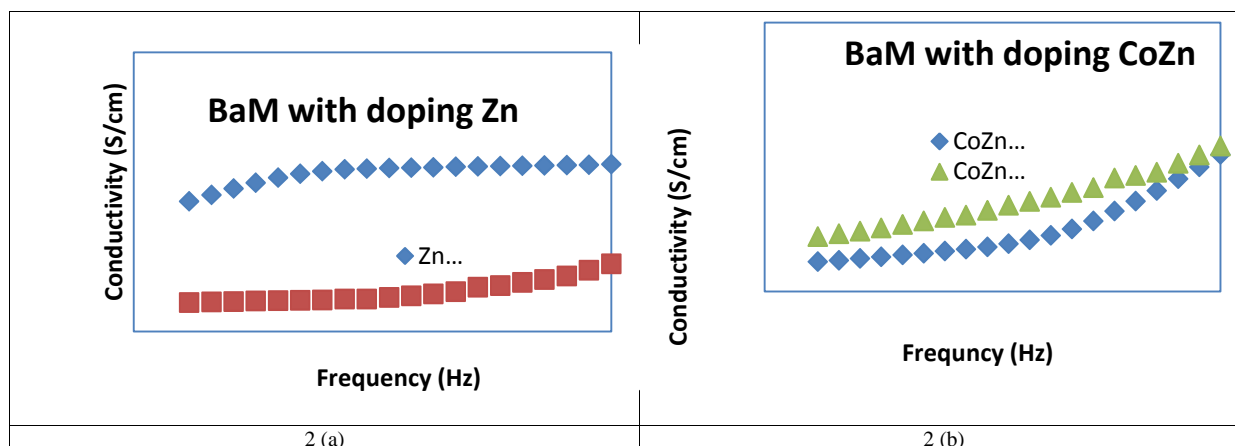

Figure 2. (a) log conductivity versus log frequency for BaM with doping Zn and (b) log conductivity versus log Frequency for BaM with doping Co-Zn

From Figure 1 (a) shows that the conductivity values without doping BaM shows the value increasing with increasing frequency of, showed that the increased conductivity occurs liner. At low frequencies the conductivity value of $4.27 \cdot 10^{-7}$ S / cm at a frequency of 10^5 Hz, while the value of conductivity is $9.32 \cdot 10^{-5}$ S / cm. From Figure 1 (b) - 2 (b) the value of the conductivity can be seen in the following table 1.

Table.1. Conductivity of samples in the range frequency below 100 Hz and above 100 to 10^5 Hz

Frequency (Hz)	Conductivity (S/cm)					
	Co (400 ^o C)	Co (800 ^o C)	Zn (400 ^o C)	Zn (800 ^o C)	Co-Zn (400 ^o C)	Co-Zn (800 ^o C)
0.5 – 100	$(4.8-9) \cdot 10^{-8}$	$(1.68-3.7) \cdot 10^{-7}$	$(5.3 -7.1) \cdot 10^{-7}$	$(1.8 \cdot 10^{-4} - 1.0 \cdot 10^{-3})$	$(3.6-6.14 \cdot 10^{-8})$	$(1-2) \cdot 10^{-7}$
>100 - 10^5	$(1-3) \cdot 10^{-6}$	$(4.5 -7.4) \cdot 10^{-6}$	$7.7 \cdot 10^{-7} - 5 \cdot 10^{-6}$	$1.1 \cdot 10^{-3} - 1.5 \cdot 10^{-3}$	$6.7 \cdot 10^{-8} - 3.5 \cdot 10^{-6}$	$2.4 \cdot 10^{-7} - 3.48 \cdot 10^{-6}$

From Table 1. show that conductivity increases with increasing temperature calcinations for all types of doping used. The conductivity also increased with increasing

frequency, at low-frequency conductivity tends to a constant value while at high frequencies the conductivity increases linearly. This may be interpreted in a way that at low range of frequency, the jumping of electrons between Fe²⁺ and Fe³⁺ is less but as frequency goes to the higher values, the hopping of electrons is increased and conductivity is also increased [4]. All samples exhibit a frequency-independent conductivity at low frequencies and a frequency-dependent conductivity at high frequencies due to ionic conductivity relaxation. The higher conductivities were attributed to the increase of ionic charge carriers in the samples. The increment of temperature causes an increase in conductivity due to the increase of free volume and their respective ionic and segmental mobility. Thus segmental motion, which is temperature dependent, permits free charges to hop from one site to another or provides a pathway for the transitional ionic motion. The conductivity increases as the temperature, indicating more ions gained kinetic energy via the thermally activated hopping of charge carrier between trapping sites that is temperature dependence and phonon-assisted quantum tunneling through a barrier separating two equilibrium positions, which is hopping distance dependent. Both mechanisms contributed to the ionic mobility and increase total conductivity. The conductivity in ferrites may be elaborated by Verwey's hopping mechanism. The electronic conduction in hexaferrites is mainly due to hopping of electrons between ions of the same element present in more than one valence states [6].

4. Conclusion

The results showed conductivity samples for doping Co, Zn and Co-Zn increases with increasing calcination temperature and conductivity also depends on the frequency, the low frequency tends to a constant value but at a higher frequency increased. Increase in conductivity with rise in temperature shows semiconducting nature of the samples.

Acknowledgements

This research has been sponsored by PUPT Research Department of Research and Technology of Higher Education 2016.

References

- [1] M. Radwan, M.M. Rashad, and M.M. Hessian. 2007. Synthesis and characterization of barium hexaferrite nanoparticles. *J. Mater. Process. Technol.* 181, 106.
- [2] T. Gonzalez-Carreno, M.P. Morales, and C.J. Serna. 2000. Barium ferrite nanoparticles prepared directly by aerosol pyrolysis. *Mater. Lett.* 43, 97.
- [3] M. Cernea, S.G. Sandu, C. Galassi, R. Radu, and V. Kuncser. 2013. Magnetic properties of Ba_xSr_{1-x}Fe₁₂O₁₉ (x = 0.05–0.35) ferrites prepared by different methods. *J. Alloys Compd.* 561, 121.
- [4] M.N. Ashiq, M.J. Iqbal, M. Najam-ul-Haq, P.H. Gomez, and A.M. Qureshi. 2012. Synthesis, magnetic and dielectric properties of Er–Ni doped Sr-hexaferrite nanomaterials for applications in high density recording media and microwave devices. *J. Magn. Magn. Mater.* 324, 15.
- [5] P. Bhattacharya, S. Dhibar, G. Hatui, A. Mandal, T. Das, and C.K. Das. 2014. Graphene decorated with hexagonal shaped M-type ferrite and polyaniline wrapper: A potential candidate for electromagnetic wave absorbing and energy storage device applications. *RSC Adv.* 4, 17039.
- [6] M. U. Islam, F. Aen, S. B. Niazi, M. A. Khan, M. Ishaque, T. Abbas, & M. U. Rana. 2008. Electrical transport properties of CoZn ferrite–SiO₂ composites prepared by co-precipitation technique. *Materials Chemistry and Physics*, 109(2), 482–487.
- [7] T. Kaur, B.H. Bhat, S. Kumar, and A.K. Srivastava. 2015. Enhancement in physical properties of barium hexaferrite with substitution. *Journal of Materials Research*, 30(18), 2753–2762.
- [8] Y. Liu, M.G.B. Drew, Y. Liu, J. Wang, and M. Zhang. 2010. Preparation, characterization and magnetic properties of the doped barium hexaferrites BaFe_{12-2x}Cox/2Znx/2SnxO₁₉, x=0.0–2.0. *J. Magn. Magn. Mater.* 322, 814.
- [9] H. Sozeri, I. Kuucuk, and H. Ozkan. 2011. Improvement in magnetic properties of La substituted BaFe₁₂O₁₉ particles prepared with an unusually low Fe/Ba molar ratio. *J. Magn. Magn. Mater.* 323, 1799.

- [10] M.K. Tehrani, A. Ghasemi, M. Moradi, and R.S. Alam. 2011. Wideband electromagnetic wave absorber using doped barium hexaferrite in Ku-band. *J. Alloys Compd.* 509, 8398.
- [11] T. Kaur, B. Kaur, B.H. Bhat, S. Kumar, and A.K. Srivastava. 2015. Effect of calcination temperature on microstructure, dielectric, magnetic and optical properties of Ba_{0.7}La_{0.3}Fe_{11.7}Co_{0.3}O₁₉ hexaferrite. *Phys. B* 456, 206.
- [12] V. V. Soman, V. M. Nanoti, and D. K. Kulkarni. 2014. Effect of substitution of Zn-Ti on magnetic and dielectric properties of BaFe₁₂O₁₉. *Physics Procedia*, 54, 30-37.
- [13] A. Sharma, K. Parmar, R. K. Kotnala, and N. S. Negi. 2012. Magnetic and Dielectric Properties of Co_xZn_{1-x}Fe₂O₄ Synthesized by Metallo-Organic Decomposition Technique. *International J. Adv. Engg. Tech*, 5, 544-554.
- [14] A. Rahman, A. Gafur, and A.R Sarker. 2015. Impact of doping on Structural, Electronic and Optical Properties of Cobalt Ferrite Prepared by Solid-state Reaction. *International Journal of Innovative Research in Advanced Engineering (IJIRAE) ISSN: 2349-2163 Volume 2 Issue 1*.
- [15] R. Rani, G. Kumar, K. M. Batoor, and M. Singh. 2013. Electric and dielectric study of zinc substituted cobalt nanoferrites prepared by solution combustion method. *American Journal of Nanomaterials*, 1(1), 9-12.
- [16] C. C. Chauhan, R. B. Jotania, and K. R. Jotania. 2012. Conductivity and dielectric properties of M-type barium magnesium hexaferrite powder. *Int J Adv Eng Res Stud*, 1, 25-27.
- [17] S. Kanagesan, M. Hashim, T. Kalaivani, I. Ismail, N. A. Rahman, and A. Hajalilou. 2014. Microwave sintering of NiCo doped barium strontium hexaferrite synthesized via sol-gel method. *Journal of Chemical and Pharmaceutical Research*, 6, 1210-1215.
- [18] K. K. Mallick, P. Shepherd, and R. J. Green. 2007. Dielectric properties of M-type barium hexaferrite prepared by co-precipitation. *Journal of the European Ceramic Society*, 27(4), 2045-2052.
- [19] G. Sathishkumar, C. Venkataraju, and K. Sivakumar. 2010. Synthesis, structural and dielectric studies of nickel substituted cobalt-zinc ferrite. *Materials Sciences and Applications*, 1(01), 19.
- [20] N. Dawar, M. Chitkara, I. S. Sandhu, J. S. Jolly, and S. Malhotra. 2016. Structural, magnetic and dielectric properties of pure and nickel-doped barium nanohexaferrites synthesized using chemical co-precipitation technique. *Cogent Physics*, 3(1), 1208450.

Detection of Lombok Faults using Gravity Methods

Suhayat Minardi ¹, Teguh Ardianto ¹, Alfina Taurida Alaydrus ¹

^{1,2,3} Physics Department University of Mataram
Email : suhayat.minardi@unram.ac.id

Abstract

Research with the gravity method with the aim to detect the presence of fault has conducted on the Lombok Island. Gravity measurements was done in Central Lombok and East Lombok Regency using Scintrex autograv CG5 gravimeter on August, 22 -25, 2016. The stations (measurement points) have distributed randomly at the roads that traversed at Central Lombok and East Lombok Regency. Separation anomaly was conducted using upward continuation and modelling results verified by a second vertical derivative (SVD) and the geological map of Lombok and Sumbawa issued by the P3G Bandung 1994. Modelling results showed that the survey area has developed by soil, sandstone, limestone and andesit layer. The faults at the survey area were occurred at depth of 40 until 264 meter.

Keywords: *fault, gravity, Lombok, modelling, SVD*

1. Introduction

The area of subduction by the Indo-Australian plate extends to the west of Sumatra Island, south of Java to Bali and Nusa Tenggara Islands, moving to north about (50-70) mm/year [1]. The Indonesia's geological setting causes frequent earthquakes in various parts of Indonesia, especially on the island of Lombok West Nusa Tenggara province, which is geographically located at the confluence of two major tectonic plates, Eurasian Plate and Indo-Australian Plate. Plate movement that is the trigger of faults activity across most areas of the island of Lombok. If the faults becomes active then passed into the area prone to earthquakes [2].

Fault occurs due to a shift in the earth layer of normal conditions. Passive fault can be reactivated under the influence in the surrounding, such as the effect of volcanoes or other seismic activity. Therefore fault activity still need special attention and further research, especially faults that exist on the Lombok Island is still less attention.

Lombok Island has a geological structure which is divided into three zones, mountains, hills, and plains. Obviously with such geological structure, the island of Lombok has a fault on the plates underneath the earth's surface. One prediction of fault there is a fault Lombok, that has a length about 75 km with Northeast-Southwest trending, while other faults trending fault-Northwest-Southeast and few in number almost North-South trending [3].

One of the geophysical methods that can be used to study the fault is the gravity method [4] [5]. When a 3-dimensional shape of any mass distributed continuously with density $\Delta\rho(\alpha, \beta, \gamma)$ as shown in Figure 1, the potential of gravity at the point P (x, y, x) above and beyond the distribution the mass density is given by [6]:

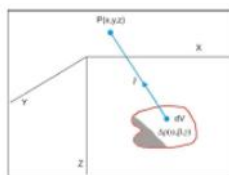

Figure 1 Potential effect of gravity at point P

$$U(x,y,z) = K \iiint \frac{\Delta\rho(\alpha, \beta, \gamma)}{[(x-\alpha)^2 + (y-\beta)^2 + (z-\gamma)^2]^{3/2}} d\alpha \cdot d\beta \cdot d\gamma \dots\dots\dots(1)$$

Vertical component of gravity caused by density distribution can get by differentiating equation 1 to z.

$$\Delta_{gz} = -\frac{\partial U}{\partial z} = -K \int_0^\infty \int_{-\infty}^\infty \int_{-\infty}^\infty \frac{\Delta\rho(\alpha, \beta, \gamma)(z-\gamma)}{[(x-\alpha)^2 + (y-\beta)^2 + (z-\gamma)^2]^{3/2}} d\alpha \cdot d\beta \cdot d\gamma \dots\dots\dots(2)$$

2. Materials and Methods

The research location are the Central and East Lombok Regency, as shown at Figure 2. Measuring gravity using a gravity meter Scintrex Autograv CG-5 with the number of measurement points 85 points. Data processing was done by Microsoft Excel and modelling is done by using software Oasis Montaj. Stages of work in this research is shown in Figure 3. As verification of modelling results, use the geological map sheet Lombok and Sumbawa issued by the Bandung P3G (1994) [7].



Figure 2. Location of research

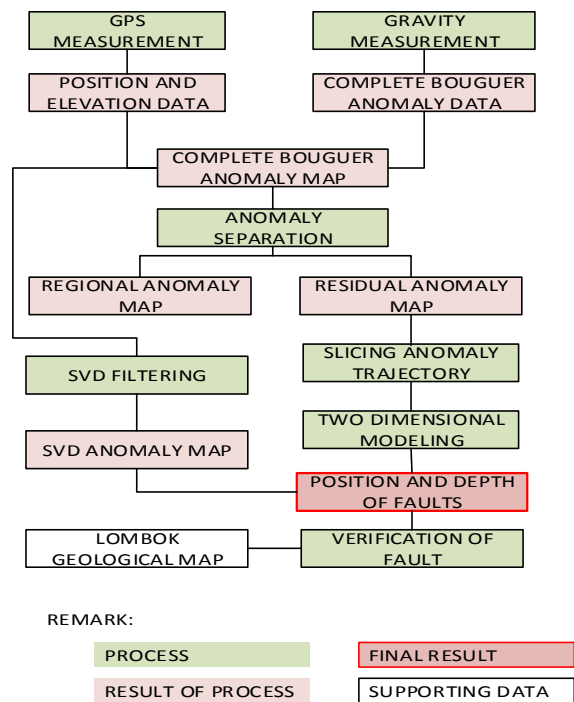

Figure 3. Diagram the stages of research

3. Discussion

The measurement results of Global Positioning System (GPS) data is processed to obtain the position and elevation measurement points. The data is then plotted on the map and produces elevation maps as shown in Figure 3. The study area has a height variation from 50 to 350 meters above sea level. The gravity data after the data is processed to produce a complete Bouguer anomaly and plotted into the map as shown in Figure 4. The value of the gravity anomaly varies between -80 to 140 mGal.

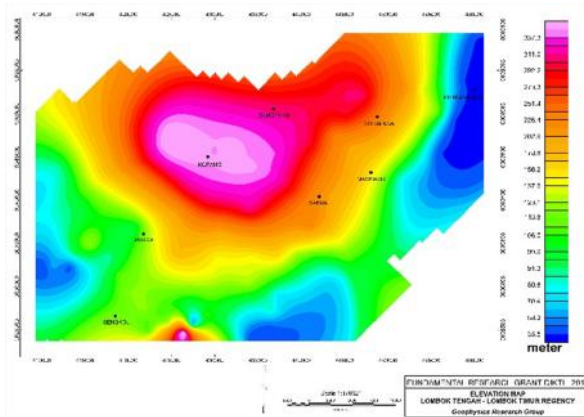

Figure 3. Elevation map

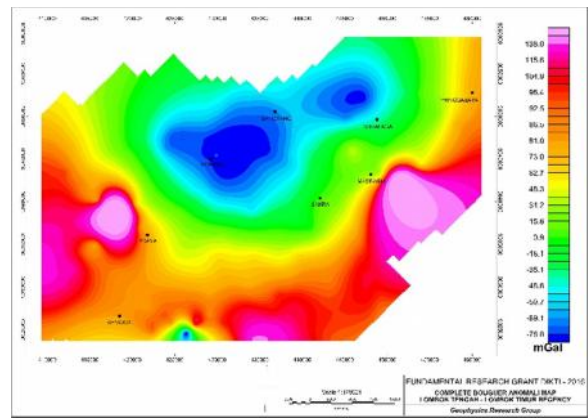

Figure 4. Bouguer anomaly map

Bouguer anomaly is a combination of regional anomaly residual anomaly, so to get the anomaly is due to local sources, the two should be separated. The anomaly separation process using upward continuation method, and the result is a residual anomalies as shown in Figure 5. The residual anomaly maps created cross section to be modelled anomalies below the surface conditions.

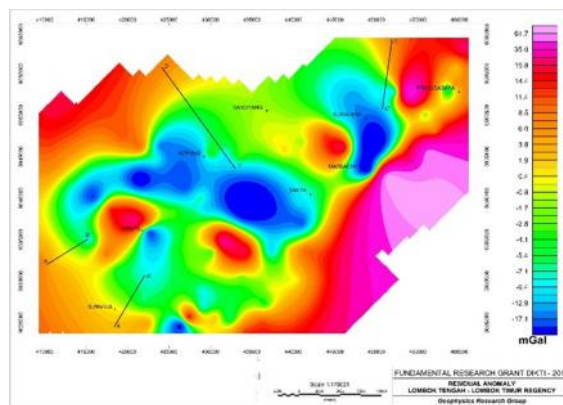

Figure 5. Residual anomaly map with lines of slicing to be modelled

Four cross-sections, that's AA', BB', CC' and DD' are made to model subsurface conditions. Sub-surface models under cross sections AA', BB', CC', and DD' can be shown in Figure 6 until Figure 9. Position of all cross sections, quantitative interpretation as a results of modelling (depth of fault and layer of rocks faulting) shown in Table 1. All of cross sections are composed of soil, sandstone, limestone, and andesite, based on density value by [8].

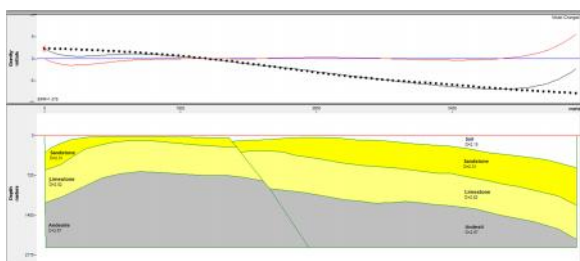

Figure 6. Subsurface model cross section AA'

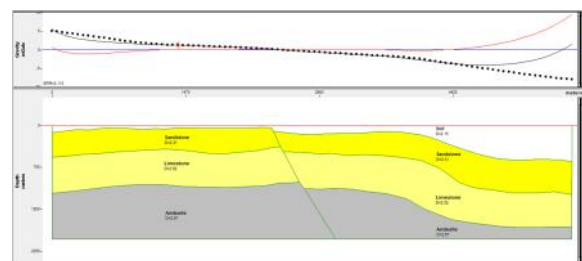

Figure 7. Subsurface model cross section BB'

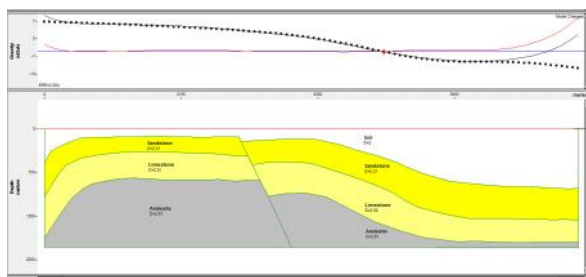

Figure 8. Subsurface model cross section CC'

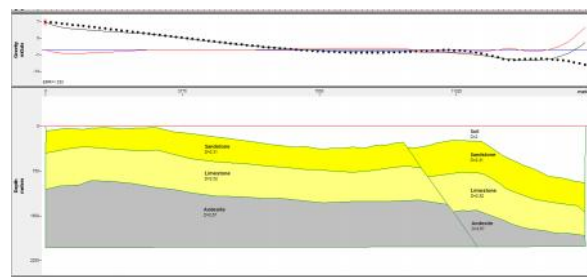

Figure 9. Subsurface model cross section DD'

Table 1. Position of cross sections and the parameters of models

No.	Cross section	Point (m)		Length (m)	Depth of fault (m)	Rocks layer
		Start	End			
1.	AA'	Start	(418429, 9024569)	7035	39.5	Soil ($\rho = 2.05$ gr/cc) Sandstone ($\rho = 2.31$ gr/cc) Limestone ($\rho = 2.52$ gr/cc) Andesite ($\rho = 2.67$ gr/cc)
		End	(422020, 9030618)			
2.	BB'	Start	(410395, 9031941)	5740	40.2	
		End	(415215, 9035061)			
3.	CC'	Start	(451889, 9059069)	8394	156.5	
		End	(450755, 9050751)			
4.	DD'	Start	(424194, 9055666)	14879	263.8	
		End	(432985, 9043662)			

Second Vertical Derivative (SVD) is one of the filtering techniques that can bring residual anomaly (shallow effect). With this method, the presence of a fault in one area will be known [8] SVD contour value is 0 mGal/m² indicates that in the area there are structural faults, so that the map of residual anomalies and modelling can be expected to fault the position as shown in Figure 9. Fault estimated on the ellipse of red and blue and is consistent with the geological map in Figure 10.

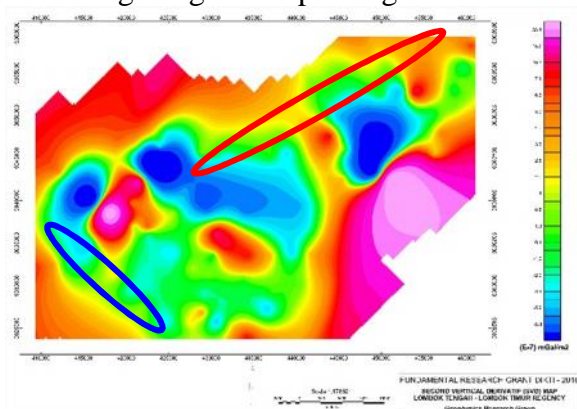

Figure 9. SVD map

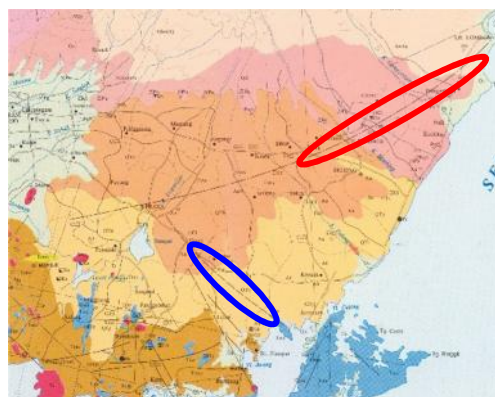

Figure 10. Geological map of Lombok Island

4. Conclusion

Modelling results showed that the survey area has developed by soil, sandstone, limestone, and andesit layer. The faults at the survey area were occurred at depth of 29 until 263 meter.

Acknowledgment

Thanks to DP2M DIKTI authors say that has funded this research with the contract

number 61H/ SPP-FD/ UN18.12/ PL/ 2016 dated 20 February 2016, colleagues from BMKG Kemayoran Jakarta, Physics Laboratory University of Mataram, and the students who has helped conduct the study.

References

- [1] Pasau, G., dan A. Tanauma. 2011. Pemodelan Sumber Gempa di Wilayah Sulawesi Utara Sebagai Upaya Mitigasi Bencana Gempa Bumi. *Journal science of MIPA*. 7:1-5.
- [2] Kertapati E., 2006. *Aktivitas Gempabumi di Indonesia (Perspektif Regional pada Karakteristik Gempabumi Merusak)*. Bandung: Pusat Survey Badan Geologi.
- [3] Manurung.Y.S dan Karno, 1997. Hasil Eksplorasi Mineral Logam Di Daerah Mataram, Kabupaten Lombok Barat dan Lombok Tengah, Propinsi Nusa Tenggara Barat. DSM. Bandung.
- [4] Sarkowi M., (2009) : Coal Bed Methane Sebagai Energi Alternatif Baru dan Upaya Pemantauan Proses Produksinya. *Proceeding Seminar Nasional MIPA 2009*, 16-17 Nopember 2009.
- [5] Yoshida Shigeo, Gaku Seta, Shuhei Okubo, and Shigeki Kobayashi, 1999. Absolute gravity change associated with the March 1997 earthquake swarm in the Izu Peninsula, Japan. *Earth Planets Space*, 51, 3–12, 1999
- [6] Kadir W.G.A., Santoso D., dan Sarkowi M (2004) : Time Lapse Vertical Gradient Gayaberat mikro Measurement for Subsurface Mass Change and Vertical Ground Movement (Subsidence) Identification, Case Study: Semarang Alluvial Plain, Central Java, Indonesia. *Proceedings of The 7th SEGJ International Symposium, Sendai- Japan 24-26 Nopember 2004* p.421-426
- [7] P3G, 1994, Peta geologi lembar Lombok dan Sumbawa Bandung
- [8] Lestari, Intan dan M. Sarkowi, 2013, Analisis Struktur Patahan Daerah Panasbumi Lahendong - Tompaso Sulawesi Utara Berdasarkan Data Second Vertical Derivative (Svd) Anomali Gayaberat, *Prosiding Seminar Nasional Sains & Teknologi V Lembaga Penelitian Universitas Lampung 19-20 November 2013*
- [9] Telford, W. M., Geldart, L. P. and Sheriff, R. E., 1990., *Applied Geophysics Second Edition*, Cambridge University Press, New York

Description of Cognitive Conflict Levels in Chemistry College Students in Conceptual Change Strategy

Rosalina Eka Permatasari^{1*}, Suyono²

1) Doctorate Degree Student of Science Education, Postgraduate, State University of Surabaya, Surabaya.

E-mail: Rosalina.permatasari88@gmail.com

2) Department of Chemistry, Science Faculty, State University of Surabaya, Surabaya.

*E-mail: ionunesa@yahoo.co.id

Abstract

This study aimed to describe the level of cognitive conflict students in conceptual change strategy. This research type is a case study with the goal of three students from Chemical Education Department (trainee teachers) who have a high burden of misconceptions on Arrhenius acid-base concept. They have a visual-verbal balanced of learning style and low of imagination. The variables which measured, photographed and studied was the level of cognitive conflict when individual targets involved in cognitive conflict condition as a whole in the process of conceptual change. The method used in this research was mixed methods which combine the qualitative and quantitative methods. The level of cognitive conflict students described based on the data: (a) the answers of students to the questionnaire which were integrated in conceptual change module, (b) recording the movements of physical students when cognitive conflict event, and (c) recording of verbal or students speech who submitted to the lecturer. Recording of students gestures, signs, and body language when they took place the creation of cognitive conflict event were interpreted with reference to Nonverbal Dictionary written Givens (2002) and Guidelines on How To Read Body Language written by Pease (1988). Recording verbal or students' speeches to lecturer are written as it is. Data from the questionnaire, meaning of student's gestures, signs, and body language and verbal greeting were triangulation to describe the level of student cognitive conflict target. Conclusion of this research was cognitive conflict level about three students who targeted as research objectives differ from one another. First Students target has high levels of cognitive conflict, positive, and consistent. Second Students target had lower levels of cognitive conflict, positive, and consistent. Third Students target has a low level of cognitive conflict, positive, and tend to be inconsistent.

Key Words: *burden of misconceptions, individual characteristics, variants of conceptual change strategy*

1. Introduction

Through IonunesaDetektor software, it has been successfully mapped conception of chemistry, learning styles, mental models, and the level of cognitive conflict of students of Chemistry Education Department Unesa. Individual learning styles were measured in four dimensions, namely perception, input, process, and understanding. Individual mental models are measured in three dimensions, namely perception, imagination, and understanding discourse. Individual mental models are classified into three levels: low, medium, and high. Students determined to have a low mental model if the accumulated results of tests using detector test mental models conclude that students have a mental model far from the mental model target, and vice versa. The level of cognitive conflict described from three data sources, namely: (a) the answers to the questionnaire are integrated in modules of conceptual change, (b) recording of physical movements when the event of cognitive conflict condition creation

occur, and (c) recording of verbal or students' greeting submitted to the supervisor.

Students of Unesa Education Chemistry Department are candidates for chemistry teacher who will substitute the existence of chemistry teacher that currently exist in field and are known to have misconceptions about subject matter that learned to their students (Suyono, Yuanita, and Rohmawati, 2012). Fact misconceptions happen on teachers not only in Indonesia, but also in other countries. Kolumuc and Tekin (2011) found teachers' chemical misconceptions in Turkey also Burgoon et al. (2011) in the United States. The presence of chemistry teachers with many misconceptions, alarming the world of education. The existence of a chemistry teacher in the field with a load of misconceptions in turn must be substituted with new teachers who know the concept. Why should it be substituted? If not, there is a concern that the misconceptions in chemistry at high school students will never be solved. While Lemma (2013) summed up the results of his research, that the index of determination of teachers' chemistry misconceptions towards students' misconceptions reached 90%. After further analysis of students' chemistry map conception (prospective chemistry teacher), found a number of students have a load of misconceptions in the various chemistry subject matter to be covered in school such as the concept of chemical bonds, solvents, acids and bases, electrochemistry, and the reaction rate (Suyono, Masriyah, and Muchlis, 2015). Suyono et al. (2015) also found a number of students who have high misconceptions, more than 50% of number of conceptual questions that tested. The load of chemistry misconceptions must be reduced (minimized), if possible eliminated. If the load of misconceptions chemistry teacher candidates were not reduced, then the substitution chemistry teachers in the same field would be useless.

Remedial teaching practices with individual clinical patterns have been conducted by Suyono and his colleagues in 2016 using conceptual change strategy. Conceptual change strategy was based on the ideas of Piaget and constructivism (Baser, 2006). According to Baser, this strategy encourages the creation of discontent in the minds of individuals against conception, cognitive conflict happen. When that kind of discontent happen so there will also re-adaptation to the individual to re-achieve a balance (equilibration) (Piaget, 1950). With a simple word, the core of the conceptual change strategy is as follows. Misconceptions that have been recorded in any individual scheme disequilibrium for further equilibrated converted into a correct conception, according to the conception of scientists. The pattern of clinical services done were very different to a study conducted by previous researchers, such as Pabuccu and Geban (2006) which states that the conceptual change strategy proven to effective in reducing students' misconceptions. The same conclusion was made by Ozdemir & Clark, 2007; Zirbel, 2004; Sinatra & Broughton, 2011; Ultay et al. 2014; Potvin et al. 2014. The studies that have been done have not provided services according the individual characteristics and proven still leaves the misconceptions burden to the individual remediation target.

The pattern of clinical services performed by Suyono et al. in 2016, in addition to individual, it also gave notice to the individual characteristics such as learning styles, mental models, and the level of cognitive conflict. These three individual characteristics correlate with the misconception happen to someone. Sen and Yilmaz (2012) along with Abosalem (2013) found a significant correlation between learning styles of students (learning style) with student misconceptions. Individual learning styles which are not well accommodated in the designed learning process will cause a failure in students' learning process. Misconceptions in chemistry correlated with mental models owned (Wang, 2007). Clerk and Rutherford (2000) stated that misconception would occur in the brain when the students' mental models which formed by an individual does not match the mental model that should be or targeted mental models (low mental models).

Aryungga and Suyono (2014) found that students who experience resistant misconceptions are students who have a learning style balanced on the four dimensions of

learning styles. Verawahyuni (2014) found that students who had low mental models tend to have a high burden of misconceptions. Suyono et al. (2015) found a significant relationship between student perception abilities with a load of misconceptions on the concept of atomic structure. Students with lower perceptions ability, one of mental models dimension, have a high load of misconceptions. The level of individual cognitive conflict is also known to correlate with misconceptions (Kang et al., 2004). The results of this study provide meaning that individuals who have balance learning styles, low mental model, and lower levels of cognitive conflict can be classified into disadvantaged individuals in building chemical conception. These less fortunate individuals have not been touched in particular by previous investigators in implementing the strategy of conceptual change. Meanwhile, Sen and Yilmaz (2012) along with Abosalem (2013) has warned, if the learning style (one of the characteristics of the individual) are not accommodated in the learning designed by the learner, it will cause a failure in students' learning process. A touch on the individual characteristics besides learning style is also important. Clerk and Rutherford (2000) stated that misconception would occur in the brain when the students' mental model formed by an individual does not match the mental model that should be or targeted mental model. Positive response to the statement of Clerk and Rutherford, is that learners in designing remedial action of misconceptions must provide services that help individual to have a mental model, for example the low perceptual abilities. Means that, in the implementation of conceptual change strategies need to be supplemented with other forms of services based on the characteristics of individuals, more specifically, to the less favorable characteristics. Again, these have not been done by previous researchers. The author would like to enter into this gap region.

The author has succeeded in formulating the design of remedial learning strategies to reduce the burden of student chemical misconceptions based on conceptual change strategies and individual characteristics (Suyono, Masriyah, and Muchlis, 2016). Remedial learning strategies for loads of misconceptions assigned for department of chemistry education students who have completed basic course of chemistry and identified as having: (1) the load of high misconceptions, (2) balanced learning styles, (3) low mental models, and (4) low to moderate levels of cognitive conflict. To base on the need for individual services according to individual characteristics, there have been formulated five (5) variant conceptual change strategy, namely: (1) Conceptual change strategy aided by integrated worksheet with target of balance sensing-intuitive-learning style student, low mental models, low-to moderate level of cognitive conflict (2) Conceptual change strategy aided by Module CC with target of balance visual-verbal learning style and low imagination students, (3) Guided conceptual change strategy aided by multimedia with target of balance visual-verbal learning style, medium active, and the low level of cognitive conflict, (4) Conceptual change strategy that is integrated with 3R strategy targeting the student with balance visual-verbal learning style and low mental models, and (5) Conceptual change strategy integrated with peer-learning strategy with target of balance sequential-global learning style and low-medium level of cognitive conflict students. Implementation of each conceptual change strategies variants based on individual characteristics supported by the learning device/tools consisting of remedial learning scenarios and conceptual change worksheet /modules. On this opportunity, reported description that represents the cognitive conflict level in the targeted students underwent conceptual change strategy in the second variant of the strategy. Representation of student cognitive conflict levels are set based on the observed/recorded physical movement in a hidden camera and recorded document module of conceptual change. Why need to be made a description of targeted student cognitive conflict level target?

Targeted students involved in second variant of conceptual change strategy is students with a high load of misconceptions of Arrhenius acid-base concept and has a balance visual-verbal learning style, as well as low ability of imagination. Individuals with certain types of learning styles have a tendency to typical study (Felder, 1993). The ability of imagination is

one of the elements of mental models. Mental models are knowledge structures constructed by the individual to understand and explain the experience (Rahayu&Purwanto, 2013). In understanding abstract concepts, people need a visual representation in the form of graphs, drawings and diagrams that are indispensable to explain the abstract concepts (Gabel, 1999; Chittleborough&Treagust, 2007). Conceptual change module that is used to guide the stages of conceptual change strategy in which there are services adjusted to the individual characteristics of balance visual-verbal learning style and low imagination, so that become meaningful and can tap long-term memory. Implemented stages of conceptual change strategy consist of four stages: validation of misconceptions, creating conditions of cognitive conflict in students, providing assistance for the equilibration, and reconstruction of student understanding (Suyono et al., 2016).

As mentioned in the third paragraph that the strategy conceptual change is based on in the ideas of Piaget and constructivism (Baser, 2006). According Baser, this strategy encourages the creation of discontent in the minds of individuals against conception, cognitive conflict happen. When there is discontent like that will happen re-adaptation to the individual to re-achieve a balance (equilibration) (Piaget, 1950). Creation of cognitive conflict on individuals is indispensable in the process of individual schemes prior to equilibration and re-adaptation. Creation of cognitive conflict is one of the four essential conditions that must be met in order to re-adaptation or accommodation occurs (Posner et al., 1982), namely: (1) there must be dissatisfaction of the individual against the present conception (conception old), can be conditioned by bring in anomaly, (2) a new conception must be clearly understood (intelligible), can be tested or applied for wider use in new situations, (3) a new conception must be reasonable (plausible), can be used to solve problems and have consistency, and (4) a new conception more useful (fruitful), has the opportunity or potential to support development program and pave the way of a new inquiry

If observed that the statements in the above paragraph, it is clear that the phase of creation of cognitive conflict conditions is one of important stages in the process of conceptual change. This was the argument for researchers to explicitly describe the cognitive conflict level of chemistry students in conceptual change strategy aided module. The level of student cognitive conflict affects the process of changing misconceptions, therefore, in this study the fact of students' cognitive conflict level tried to be connected to the fact of students' changes of conception which recorded in modules, especially in the reconstruction of student understanding.

Students involved in the stage of creation of conditions for cognitive conflict can be divided into three conditions, namely: (a) students who experienced cognitive conflict, (b) the student does not conflict cognitively, and (c) the students were in anxiety state that is between states of conflict non-conflict. The purpose of this study is to obtained descriptions of the level of student cognitive conflict and its success in reconstructing understanding. The level of students' cognitive conflict the students described in seven indicators, namely: (1) any doubt as to what has been believed, (2) the shock of new facts are found, (3) comfort against what has been believed, (4) an interest to learn more on new terms, (5) the level of curiosity to learn more, (6) the confusion over something that has believed, and (7) unhappiness because has not understood the new concept. This all seventh indicator refers to Lee et al. (2003). The purpose of this study was to describe the level of students' cognitive conflict in conceptual change strategy.

2. Materials and Methods

This research is a case study with the targeted students of Chemical Education department/major (prospective teachers) who have a high burden of misconceptions of Arrhenius acid-base concept, has a balance visual-verbal learning style, and has the lower

ability of imagination. The variables measured, photographed, and assessed are: (1) the level of targeted individual's cognitive conflict when involved in conditions for cognitive conflict creation event as a whole in the process of conceptual change. The method used in this research is combined methods (mixed methods), a combination of qualitative and quantitative methods. The strategy chosen was concurrent embedded strategy, both combined methods are run simultaneously and in this case quantitative methods embedded into qualitative methods (Creswell, 2009). The level of students' cognitive conflict described based on the data: (a) the answers to the questionnaire are integrated in conceptual change modules, (b) recording physical movements of the current event creation of conditions for cognitive conflict lasts, and (c) recording of students' verbal or speech which submitted to the supervisor.

Seven indicators according to Lee et al. (2003) can be used to describe the level of cognitive conflict through questionnaire method mentioned above. Answers to the questions in the questionnaire were classified into five levels 0 s.d. 4 with the following meaning:

0 = do not have doubts; shock; inconvenience; interest; curious; confusion; confidence (not at all),

1 = have doubts; shock; inconvenience; interest; curious; confusion; confidence between 1% - 25% (very low),

2 = have doubts; shock; inconvenience; interest; curious; confusion; confidence between 26% - 50% (low),

3 = have doubts; shock; inconvenience; interest; curious; confusion; confidence between 51% - 75% (high),

4 = have doubts; shock; inconvenience; interest; curious; confusion; confidence between 76% - 100% (very).

Recordings physical gestures (gestures, signs, and body language) when the creation event of cognitive conflict conditions took place interpreted with reference to Nonverbal Dictionary written by Givens (2002) and guidelines on how to read body language written by Pease (1988). Verbal or speech recordings delivered to students who are written as their supervisor. Data from questionnaire's filling, of the meaning of gestures, signs, and body language and verbal greeting each triangulated to describe the level of targeted student cognitive conflict.

3. Results and Discussion

3.1. Cognitive Conflict Levels Targeted Individual

The level of targeted students' cognitive conflict (TKKMS) is described based on the data: (a) the recognition of individuals in answer to a questionnaire that is integrated in conceptual change module, (b) recording of gestures, signs, and body language when the event creating conditions cognitive conflict lasts, and (c) recording of verbal or student speech delivered to lecturers, mutually triangulated.

3.1.1. TKKMS Questionnaire Based on answer of targeted students

The filling of student questionnaire which are integrated in conceptual change module is the recognition that represents cognitive conditions perceived by students during and after the process of creation of cognitive conflict. As mentioned that the level of students' cognitive conflict described in seven indicators, namely: (1) any doubt as to what has been believed, (2) the shock of new facts are found, (3) comfort against what has been believed, (4) interest for learn more in the new case received, (5) the level curiosity to learn more, (6) the confusion over something that has believed, and (7) unhappiness because it has not understood the new concept. The level of threetargeted students' cognitive conflict during misconceptions revision on the concept of Arrhenius acids are presented in Table 1.

Table 1 Level of Cognitive Conflict of Three Students Based on Questionnaire Filling

Targeted Students	Conflict Creation 1							Conflict Creation 2						
	1	2	3	4	5	6	7	1	2	3	4	5	6	7
1	3	3	3	4	4	3	3	2	2	3	4	4	3	3
2	1	2	1	4	4	2	3	2	2	2	4	4	3	3
3	1	1	1	4	4	2	1	3	3	2	4	4	2	2

Description of the first targeted student cognitive conflict level on the implementation of conceptual change strategies to revise misconceptions of Arrhenius acid is as follows:

- 1) Doubt about what has been believed, the shock of the new facts are found, and comfort to what has been believed to be at level 3, high.
- 2) The interest to learn more in the new case received and the level curiosity to learn more deeply, both at the level of 4, very high.
- 3) The confusion over something that has been believed and unhappiness because they have not understood the new concept is at level 3, high.

Description of the second targeted student cognitive conflict level on the implementation of conceptual change strategies to revise misconceptions of Arrhenius acid is as follows:

- 1) Doubt about what has been believed and comfort to what has been believed to be 1, very low.
- 2) The shock of the new facts at the level of 2, low.
- 3) The interest to learn more in the new case received and the level curiosity to learn more deeply, both at the level of 4, very high.
- 4) Confusion over something that has been believed to be at level 2, low.
- 5) Unhappiness because they have not understood the new concept is at level 3, high.

Description of the third targeted student cognitive conflict level on the implementation of conceptual change strategies to revise misconceptions of Arrhenius acid is as follows:

- 1) Doubt about what has been believed, the shock of the new facts are found, and comfort to what has been believed to be at level 1, very low.
- 2) The interest to learn more in the new case received and the level curiosity to learn more deeply, both at the level of 4, very high.
- 3) The confusion over something that has been believed to be at level 2, is low.
- 4) Unhappiness because they have not understood a new concept at the level 1, very low.

3.1.2. TKKMS Based on Gestures, Signs, and Body Language Recording When Conflict Condition Cognitive Creation Event Occur

Chemical Conceptual change module which used to guide the process of changing student's misconceptions leads twice the creation of conditions of cognitive conflict. Description of cognitive conflict level of the three targeted students based on the recording of gestures, signs, and body language presented below.

3.1.2.1 When the First Creation Conflict Conditions

In the first phase of cognitive conflict, students are faced with an anomaly data. Anomaly data here are two of the seven compounds that are all H atoms on compounds of formula but not the examples of the acid Arrhenius. Description of the three targeted students' level of cognitive conflict conditions are as follows:

- a. Student target no. 1, when face this data is holding chin and then switch to the cheek with a serious expression. According to Pease (1988), this kind of attitude is interpreted as mistrust or dubious data read.
- b. Students target no. 2, when understanding data is constantly moving his legs. According to Pease (1988) this attitude showed anxiety and confusion.

- c. Students target no. 3, holding the lips with the right thumb and just turn the module page over and over. Its meaning (Givens, 2002) is a nonverbal sign of verbal fraud, fraud on the truth or lying. Nonverbal cues can be used as a reliable indicator on anxiety and stress.

3.1.2.2. When the Second Creation Conflict Conditions

In the second phase of cognitive conflict, students are faced with the scientific conception of the Arrhenius acid. Description of the three targeted students cognitive conflict level objectives are as follows:

- a. Students target no. 1, when face of this conflict is confused; this is indicated by keep moving legs while reading the scientific conception of the acid.
- b. Students target no. 2, when reading the scientific conception of the acid is change the leg position from bent into straighten then bent over and over and moving his mouth like trying to understand the reading repeatedly. This indicates that the student is currently undergoing confusion.
- c. Students target no. 3; keep turn over the module page with an expression of confusion.

3.1.3 TKKMS Based on Verbal or Speech Students Recording Presented to Lecturer Assistants

There are no utterances coming out of the mouth of the three reaserach targeted students' for event creation of conditions for cognitive conflict.

3.1. Description Based on Cognitive Conflict Levels of Three Sources of Data

The targeted students' level of cognitive conflict of triangulation based data sources: (a) the recognition of individuals in answer to a questionnaire that is integrated in the conceptual change module, (b) recording of gestures, signs, and body language when the event creating conditions cognitive conflict lasts, and (c) recording verbal or speech delivered to the student supervisor are as follows:

3.2.1. Student target no. 1

Confusion, sadness/unhappiness, distrust, doubt, high shock when presented to him is an indication of cognitive conflict in the student's brain. In addition, these students have an interest and very high curiosity for a deeper study on accepted new things. Based on the description it can be concluded that the student target no. 1 have high and positive levels of cognitive conflict. Tested positive, because there is a comfortable feeling against what has been believed (the old conception of the misconceptions) is experiencing confusion and sadness/unhappiness with a high level of interest and curiosity to learn more new things received. This description applies to the first creation of conditions conflict. Different Condition conflict when students are involved in the second creation of conditions conflict.

At the time of the second creation of conflict conditions, doubts about what had been believed and his shock at the new facts are found to be at a low level, while for other indicators the same as the time of fist creation of conflict. Low doubt and shock students today might because he has never experienced the atmosphere of earlier conflicts.

3.2.2 Students target no. 2

Confusion and anxiety occurred in student target no. 2, but the doubt and shock when presented to him is very low and low. This condition is an indication that cognitive conflicts that occur in the brain is not as strong as the students who happen to student target no. 1. Student target no. 2 have a very high interest and curiosity for a deeper study on new things and feelshighly sadness when hecan not understand the new concept. Student target 2 has a low level of cognitive conflict but still be declared as positive. Tested positive, because he has

an interest and curiosity is very high for a deeper study on new things to be accepted at this time. In addition, he is also has a high level of sadness because he has not understood the new concept. The description happen when the first creation of conflict condition, while the second creation of conflict conditions that both descriptions are not much different.

3.2.3. Students target no. 3

Anxiety, stress, and confusion coloring the third target student, but the confusion and sadness are low and very low. This student turned out to have a very high interest and curiosity to learn more about the new things that were presented. What is described is valid when the first creation of conflict condition, while different things happened at the time when the second creation of conflict conditions. On the second creation of conflict condition, doubts about what has been believed, and the shock of the new facts that are found in high levels, when in the first creation of condition conflict is very low. Student target no.3 does not seem to be at a consistent conflict level.

3.3. Discussion Result

Three student research targets are students to have almost the same the "fate" and individual characteristics. All three have high burden of chemical misconceptions, equally experienced misconceptions on the concept of Arrhenius acid, and classified to the individual balance visual-verbal and low imagination skills. The three then involved in remedial learning with the same strategy that is conceptual change aided by Conceptual Change Chemistry Module. That is, a module that is used to guide the conceptual change process is the same.

It turned out that all three have different cognitive response when involved in the stage or process of the creation of conflict conditions. Cognitive response that attempted described through three sources of data, namely the recognition of individuals in answer to a questionnaire that is integrated in the conceptual change module, recording of gestures, signs, and body language when the conditions cognitive conflict creation event lasts, and records of verbal or students' speech which are submitted to supervisor, mutually triangulated. In this study found no utterances out of the mouth of the three targeted research students for conflict condition creation event, so the description of levels of cognitive conflict is only based on two sources of data called first.

Student cognitive conflict level 1, 2, and 3 are different from each other. Student target no. 1 has high levels of cognitive conflict, positive, and tends to be consistent. Tested positive, because although there is a comfortable feeling against what has been believed (the old conception of the misconceptions) is experiencing high level of confusion and sadness and along with very high interest and curiosity to learn more new things received. The level of first targeted student cognitive conflict can still be said to be tends to be consistent, even if there are differences in doubt and shock that too is still very reasonable because of doubt and shock students today may be because he has never experienced the atmosphere of earlier conflicts. Student target no. 2 has a low level of cognitive conflict but can still be tested positive and consistent. Tested positive, because he has a very high interest and curiosity for a deeper study on new things to be accepted at this time. In addition, he is also has a high level of sadness because he has not understood the new concept. Description of the first creation of conflict conditions, while the second creation of conflict conditions descriptions is not much different. Student target no. 3 has a low level of cognitive conflict, is still positive, but is unlikely to be at level of conflict that consistently.

According to the researcher, the difference in cognitive response time of creation of conflict conditions in the three target students are the rights of every individual. Creation of conflict conditions, according to Baser (2006) will encourage the creation of discontent in the brains of individuals against conception, cognitive conflict has been proven. Turns discontents of each individual vary. Re-adaptation to the individual to re-achieve balance or

equilibration according to Piaget (1950) starting from the discontent itself. Researcher suspects that the difference in rates of individual cognitive conflict correlates with individual success at the next stage of conceptual change, such as providing assistance for the reconstruction and understanding equilibration. That researcher's predictions also consider the opinion of Sen and Yilmaz (2012) along with Abosalem (2013) that there is a significant correlation between student learning styles which are the ways individuals respond to information with student misconceptions, certainly applies to student's chemical conception. Chemical misconceptions in individuals correlated with mental models held (Wang, 2007). When mental responses are different, implicitly Clerk and Rutherford (2000) will lead to differences in the mental processes of others. When the individual's cognitive level is different, the response time of the process of assistance to the equilibration allegedly also different. Predictions that rely on Kang et al. (2004) that the level of the individual cognitive conflict known to correlate with its misconception, of course the conception as well.

Remedial learning strategies based on conceptual change strategy that has been implemented is still open for amendment. As is well known, phases of the strategy which has been implemented consisting of four stages: validation of misconceptions, creating conditions of cognitive conflict in students, providing assistance for the equilibration, and reconstruction of student understanding. Completion focusing on the stage of conflict conditions creation should be directed to four important conditions that must be met in order to re-adaptation or accommodation occurs (Postner et al., 1982), namely: (1) there must be dissatisfaction of the individual against the conception that there is (old conception), can be conditioned by bringing anomaly, (2) a new conception must be clearly understood (intelligible), can be tested or applied for wider use in new situations, (3) a new conception must be reasonable (plausible), can be used to solve issues and have consistency, and (4) a new conception must be more useful (fruitful), has the opportunity or potential to support development program and pave the way a new inquiry. Four of these conditions must still be tailored to the different levels of cognitive conflict each individual.

4. Conclusion

The level of three research students cognitive conflict objectives differ from one another. Student target 1 has high levels of cognitive conflict, positive, and consistent. Student target 2 has lower levels of cognitive conflict, positive, and consistent. Student target 3 has a low level of cognitive conflict, positive, and tends to be inconsistent.

References

- [1]. Abosalem, Yousef Mahmoud. (2013). *The Relationship Between the Learning Styles of Students in Grades Five and Six and Their Held Misconceptions About Dividing Fractions Based on Kolb's Model*. Thesis. Dubai: The British University.
- [2]. Aryungga dan Suyono. (2014). *Identifikasi Gaya Belajar Siswa yang mengalami Miskonsepsi Resisten pada Konsep Kimia*. Unesa Journal of Chemical Education, vol. 3 pp 127-134.
- [3]. Baser, Mustofa. (2006). *Effect of Conceptual Change Oriented Instruction on Student's Understanding of Heat and Temperature Concept*. Journal of Maltese Education Research, 4 (1), 67-79.
- [4]. Burgoon, Judee, K., Laura, K. G. and Katy Floyd. (2011). *Nonverbal Communication*. Boston: Allyn and Bacon.
- [5]. Chittleborough, G. and Treagust, D.F. (2007). "The modelling ability of non-major chemistry students and their understanding of the sub-microscopic level". *Chemistry Education Research and Practice*, Vol 8 No. 3. 2007. Pp. 274-292.
- [6]. Clerk, D. and Rutherford, M. (2000). "Language As a Confounding Variable in The Diagnosis of Misconceptions." *Int. J. Sci. Educ.* Vol 22. No. 7. 2000. pp. 703-717.
- [7]. Creswell, John W. 2009. *Research Design Pendekatan Penelitian Kualitatif, Kuantitatif, dan Mixed*. Yogyakarta: Pustaka Pelajar. Penerjemah Achmad Fawaid.
- [8]. Felder, Richard M. (1993). "Reaching the Second Tier: Learning and Teaching Styles in College Science Education." *J. College Science Teaching*, Vol. 2, No. 5, p. 286-290.
- [9]. Gabel, D. (1999). *Improving Teaching and Learning Through Chemistry Education Research: A Look to*

- the Future. *J. Chem. Educ.*, 76(4), 548.
- [10]. Givens, David B. (2002). *The Nonverbal Dictionary of Gestures, Signs, and Body Language Cues*. Spokane, Washington: Center for Nonverbal Studies Press.
- [11]. Kang, S., Scharmann, L. C., & Noh, T. (2004). Reexamining The Role of Cognitive Conflict in Science Concept Learning. *Research in Science Education*, 34(1), 71-96.
- [12]. Kolomuc, Ali & Tekin, Seher. (2011). Chemistry Teachers' Misconception Concerning Concept of Chemical Reaction Rate. *Eurasian J. Phys. Chem. Educ.*, 3(2), 84-101.
- [13]. Lee, et al. 2003. *Development of an Instrument for Measuring Cognitive Conflict in Secondary Level Science Classes*. *Research in Science Teaching* vol 40 (6).
- [14]. Lemma, Abayneh. (2013). A Diagnostic Assessment of Eighth Grade and Their Teachers' Misconceptions About Basic Chemical Concepts. *AUCE*, 3(1), 39-59.
- [15]. Ozdemir and Clark. (2007). An Overview of Conceptual Change Theories. *Journal of Mathematics, Science and Technology Education*. 3, (4), 351-361.
- [16]. Pabuccu, A., & Geban, O. (2006). Remediating Misconceptions Concerning Chemical Bonding through Conceptual Change Text. *Hacettepe University Journal of Education*, 30, 184-192.
- [17]. Pease, Allan. (1988). *Body Language: How to read others' thoughts by their gestures*. London: Sheldon Press.
- [18]. Piaget, J. (1950). *The Origins of Intelligence in Children*. New York: International Universities Press, Inc.
- [19]. Posner, G. J., Strike, K. A., Hewson, P. W., & Gertzog, W. A. (1982). Accommodation of A Scientific Conception: Toward a Theory of Conceptual Change. *Science Education*, 66(2), 211-227.
- [20]. Potvin, P. And Hasni, A. (2014). *Interest, motivation and attitude towards science and technology at K-12 levels: a systematic review of 12 years of educational research*. *Journal Studies in Science Education*. Volume 50, 2014-Issue 1.
- [21]. Rahayu, S., & Purwanto, J. (2013). Identifikasi Model Mental Siswa SMA Kelas X pada Materi Hukum Newton tentang Gerak. *Kaunia Jurnal Sains dan Teknologi*, 9(2), 12-20.
- [22]. Sen, Senoldan Yilmaz, Ayha. (2012). "The effect of learning styles on students' misconceptions and self-efficacy for learning and performance." *Procedia - Social and Behavioral Sciences*, Vol. 46, Hal. 1482-1486.
- [23]. Sinatra, G. M., & Suzanne, H. B. (2011). "Bridging Reading Comprehension and Conceptual Change in Science Education: The Promise of Refutation Text," *International Reading Association, Reading Research Quarterly* 46(4) pp. 374-393.
- [24]. Suyono, Masriyah, and Muchlis. (2015). Perception of Students Who Had Misconception in Atomic Structure Concepts. *International Conference on Mathematics, Natural Sciences, and Education (ICoMaNSEd2015) in Manado*.
- [25]. Suyono, Masriyah, and Muchlis. (2015). *Preparasi Sarjana Pendidikan Kimia Tanpa Miskonsepsi di FMIPA Unesa. Laporan Hasil Penelitian Unggulan Perguruan Tinggi* (tidak dipublikasikan). Surabaya: Lembaga Penelitian.
- [26]. Suyono, Yuanita, L., dan Rohmawati, L. (2012). Apakah Guru sebagai Pencipta Miskonsepsi Kimia pada Siswa? *Jurnal Penelitian Pendidikan Matematika dan Sains*, 2012.
- [27]. Treagust, D. F., and A. L., Chandrasegaran. (2009). *The Efficacy of an Alternative Instructional Programme Designed to Enhance Secondary Student's Competence in the Triplet Relationship*. In J. K. Gilbert and D. F. Treagust (Eds) *Multiple Representation in Chemical Education*. Boston: Springer.
- [28]. Ultay, N., Unnu, G., and Eser, U. (2014). Evaluation of the Effectiveness of Conceptual Change Texts in the REACT Strategy. *Journal Chemistry Education Research and Practice*.
- [29]. Verawahyuni, Helda. (2014). *Pengembangan Instrumen Pendeteksi Penyebab Miskonsepsi Kimia Berbasis Model Mental pada Konsep Struktur Atom*. Tesis Pasca Sarjana Unesa, Tidak dipublikasikan.
- [30]. Wang, C.Y. (2007). "The Role Of Mental-Modeling Ability, Content Knowledge, And Mental Models In General Chemistry Students' Understanding About Molecular Polarity". *A Dissertation presented to the Faculty of the Graduate School University of Missouri – Columbia*.
- [31]. Zirlbel, E, L. (2004). *Framework for Conceptual Change*. Tufts University, Department of Physics and Astronomy.

Preliminary Study And Synthesis Thin Film of Crystalline Al, Zn Co-Doped SnO₂ (Stannic Oxide) With Sol-Gel Dip Coating Technique

Aris Doyan^{1*}, Norma Ikraman¹, Susilawati¹, Syifa Azzahra¹, Zahid Ramdhan¹

*Master of Science education, Post Graduate Mataram University
Lombok Indonesia¹*

**e-mail : ^{a)}arisdoyan@yahoo.co.id*

Abstract

Stannic oxide thin film are widely used in many technology application such as Transparent Conducting Oxide (TCO), Metal Oxide Semiconductor Field Effect Transistor (MOSFET), Gas Sensors, and anti-reflection coating. In this research, we have been synthesized a thin film of crystalline pure Stannic oxide (SnO₂) and Aluminium (Al), Zinc (Zn) co-doped Stannic oxide film on a glass substrate by sol-gel dip coating technique. Sol-gel-making process using a base material powder of Tin (II) Chloride Dehydrate (SnCl₂·2H₂O), Zinc chloride (ZnCl₂), and Aluminium Chloride (AlCl₃), Ethanol and water. For undoped sol, SnCl₂·2H₂O powder dissolved in water, stirred and heated using magnetic stirrer at 100°C, 300 rpm for one hour to get cloudy yellow solution. Then Ethanol added to the solution, stirred and heated for two hours to get turbid white solution and aged for two days to get yellow solution. Furthermore to get dopant composition of 10, 50, and 100 mmol, then calculated amount of ZnCl₂, AlCl₃, and SnCl₂·2H₂O dissolve and mix with same procedure. The deposition sample of thin film Zn, Al co-doped Stannic oxide was carried out using dip coater with withdrawal speed 10 cm/min. Then the samples were baked in hot plate at temperature of 150°C for 15 minutes, followed by calcination at 550°C for one hour in muffle furnace.

Keywords: *Stannic oxide, Zinc, Aluminium, Doped, sol-gel technique, Dip Coating, substrate.*

1. Introduction

Tin dioxide (SnO₂) thin layers present potential application in many fields, in particular when good transparency in the visible range and good electrical conductivity are simultaneously required (as in displays and photovoltaics), but also for infrared properties (heat shield), or in electronic components (heterojunction). Thin layer of tin dioxide also has known that have very sensitive to the surrounding gas. This properties making the thin layer of SnO₂ as the good gas sensor.

Various methods of growing a thin layer of SnO₂, such as Chemical Bath Deposition (CBD) [1], Ultrasonic Spray Pyrolysis [2], Magnetron sputtering [3], Chemical Vapour Deposition [4], Pulsed Laser Deposition (PLD) [5], and sol-gel [6]. However, among these methods, sol-gel method is widely used, because of its low cost, its composition is homogeneous, do not use a vacuum chamber with a high level, the layer thickness can be controlled, and microstructure are quite good [6].

Tin dioxide film has known can improve their property by small amount of impurity like Antimony, Chlorin, Fluorin, Aluminium, Zinc, etc. It has been report that the small amount of Aluminium in SnO₂ Lattice film can lower the value of band gap energy and increase the transparency of SnO₂ film using sol-gel spin coating deposition [6]. In other report founded that Zinc (Zn) dopant can increase the electrical conductivity SnO₂ film that synteziied using co-precipitation methode. According that report, we will try to observe the effect of Aluminium – Zinc co-doped SnO₂ film to the propoerties of SnO₂ film using sol-dip coating

methode [7].

Based on the above background, the problems studied were: how synthesis of thin layers of crystalline undoped and Al-Zn co-doped SnO₂ film? and how the influence of variations in concentration of Alumium-Zinc Mixture to the formation of thin layers of crystalline SnO₂?

Based on the formulation of the problems mentioned above, the purpose of this study is: Synthesize thin layers of undoped and Alumunium (Al) – Zinc (Zn) co-doped SnO₂. Analyze the effect of variations in concentration of (Al) – Zinc (Zn) co-doped on the formation of thin layers of crystalline SnO₂?

2. Materials and Methods

Sol-gel-making process using a base material powder of Tin (II) Chloride Dehydrate (SnCl₂·2H₂O), Zinc chloride (ZnCl₂), and Alumunium Chloride (AlCl₃), Ethanol (C₂H₅OH) and water. For undoped sol, to get 0,4 M solution, 4,5 gr of SnCl₂·2H₂O powder dissolved in 5 ml water, stirred and heated using magnetic stirrer at 100 °C, 300 rpm for one hour to get cloudy yellow solution. Then 50 ml Ethanol added to the solution, stirred and heated for two hours to get turbidal white solution and aged for two days to get yellow solution. Furthermore to get dophant composition of 10, 50, and 100 mmol, then calculated amount of ZnCl₂, AlCl₃, and SnCl₂·2H₂O dissolve and mix with same procedure. The molarity for undoped and the doped sol was keep at 0,4 M.

The deposition sample of thin film Zn-Al co-doped Stannic oxide was carried out using dip coater. Substrate materials to be used in this study is an ordinary sodalime glass slide with dimension of 25 × 75 × 1 mm. Before use of the glass slide is Soaked in detergent containg Hydrochloric Acid for 24 hour, then hydrollized in distilled water for 24 hour, followed by rinsed with water and methanol, then dried using blower. After that, the clean substrate were dipped into the the solution with whitdrawn speed of 10 cm/min. Then the samples were baked on hot plate at temperature of 150 °C for 15 minutes, followed by calcination at 550 °C for one hour in muffle furnace.

3. Results And Discussion

Materials used in research synthesis of SnO₂ crystals with a thin layer of sol-gel method are:

1. Powder of SnCl₂·2H₂O (Molar mass 225,63 g/mol)
2. Powder of ZnCl₂ (Molar mass 136,30 g/mol)
3. Powder of AlCl₃ (Molar Mass 133,34 g/mol)
4. Ethanol C₂H₅OH with (Molar mass = 46,07 g/mol)
5. Water (H₂O)

The synthesis of SnO₂ and Al, Zn co-doped SnO₂ film crystals with a thin layer of sol-gel method following the chemical equations sol-gel as follows:

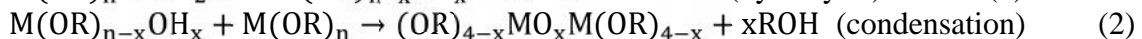
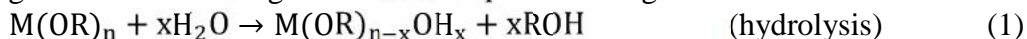

Sol-gel solution for a variation of dopant concentrations that have been synthesized are stored in a test tube as figure 1:



Figure 1. Results of Sol-Gel-varying concentration of Al-Zn dopant from left to right with a concentration of 0 %; 1 %, 5 %, and 10 %.

4. Conclusion

In this study, synthesis experiments with material precursor is Tin (II) Chloride Dehydrate ($\text{SnCl}_2 \cdot 2\text{H}_2\text{O}$) which doped Aluminium Chloride (AlCl_3), and zinc chloride (ZnCl_2). The solution to solvent and solute is ethanol ($\text{C}_2\text{H}_5\text{OH}$) and water (H_2O) For undoped sol, $\text{SnCl}_2 \cdot 2\text{H}_2\text{O}$ powder dissolved in water, stirred and heated using magnetic stirrer at 100°C , 300 rpm for one hour to get cloudy yellow solution. Then Ethanol added to the solution, stirred and heated for two hours to get turbid white solution and aged for two days to get yellow solution. Furthermore to get dopant composition of 10, 50, and 100 mmol, then calculated amount of ZnCl_2 , AlCl_3 , and $\text{SnCl}_2 \cdot 2\text{H}_2\text{O}$ dissolve and mix with same procedure. The deposition sample of thin film Zn, Al co-doped Stannic oxide was carried out using dip coater with withdrawl speed 10 cm/min. Then the samples were baked in hot plate at temperature of 150°C for 15 minutes, followed by calcination at 550°C for one hour in muffle furnace.

References

- [1] Akhiruddin Maddu, Rodo Tua Hasiholan, and Mersi Kurniati. 2006. Penumbuhan *Film Nanokristal SnO₂ dengan Metode Chemical Bath Deposition (CBD)*. Jurnal Nanosains & Nanoteknologi. Edisi Khusus. P. 95 – 99
- [2] S.M. Rozati and E. Shadmani. 2011. *Effect Of Zn Concentration On Physical Properties Of Nanostructure Tin Oxide Films Prepared By Spray Pyrolysis Technique*. Digest Journal Of Nanomaterials And Biostructures. Vol. 6, No. 2, P. 365-372
- [3] Z.Y. Banyamin, P. J. Kelly, G. West, and J. Boardman. 2014. *Electrical and Optical Properties of Fluorine Doped Tin Oxide Thin Films Prepared by Magnetron Sputtering*. Coatings 2014, 4, 732-746; ISSN 2079-6412
- [4] J. Jeong, S. P. Choi, and K. J. Hong. 2006. *Structural and Optical Properties of SnO₂ Thin Films Deposited by Using CVD Techniques*. Journal of the Korean Physical Society, Vol. 48, No. 5, pp. 960-963
- [5] A.J. Haider, S.S. Shaker and A.H. Mohammed. 2013. *A study of morphological, optical and gas sensing properties for pure and Ag doped SnO₂ prepared by pulsed laser deposition (PLD)*. Energy Procedia 36, p. 776 – 787
- [6] A. Doyan, Susilawati, and Yanika D.I.. 2016. *Synthesis and Characterization of SnO₂ thin layer with a doping Aluminum is deposited on Quartz Substrates*. ICTAP-2016. Page. 19 – 21.
- [7] R. Bargougui, A. Oueslati, G. Schmerber, C. Ulhaq-Bouillet, S. Colis, F. Hlel, S. Ammar, A. Dinia. 2014. *Structural, optical and electrical properties of Zn-doped SnO₂ nanoparticles synthesized by the co-precipitation technique*. J Mater Sci: Mater lectron 25:2066–2071

Statistical Downscaling Model Using Nonparametric Regression to Predict Temperature in Selaparang Lombok

Mustika Hadijati^{1*}, Desy Komalasari¹, Nurul Fitriyani¹

¹Mataram University, Jl. Majapahit 62, Mataram, Indonesia

* Email: mustika.hadijati@unram.ac.id

Abstract

The accurate climate informations are needed by society, in order to reduce the impact of climate change. This research aims to obtain temperature model as one of efforts to get a better climate information. The modeling of temperature use statistical downscaling method which develop the functional model between global climate data, that is air temperature of General Circulation Model (GCM), and local climate data, that is temperature in Station Selaparang. In order to reduce the dimension of GCM global data, it is obtained the projection of GCM data by factor analysis. Then, it is done the modeling of GCM temperature data projection with local temperature data by Kernel nonparametric regression. Temperature in Selaparang Lombok is predicted based on the model.

Keywords: *GCM, statistical downscaling, reduce data dimension, factor analysis, kernel nonparametric regression*

1. Introduction

Climate change gives some impacts for society. An effort to anticipate these impacts is getting accurate information/prediction of climate. In order to get accurate climate prediction, it is needed modeling of climate variable with high accuracy. One of climate variable modeling is temperature modeling.

Now, climate model developed is General Circulation Model (GCM) that have global scale. GCM is computerize base model that consist of many numerical and deterministic equation and follow physics theorems. However, information of GCM model still have global scale which is not accurate for local scale prediction. In order to get local scale information, it is done regionalization by using downscaling technique. One of downscaling technique is statistical downscaling (SD). Wigena [1] said that SD is a static downscaling process where data on high scale grids in certain period of time are used to determine data on lower scale grid. By SD, it will be developed functional relation model between GCM output information with local/regional climate variable information.

In the application of SD method, it is necessary to concern about characteristic of GCM output as predictor variable and characteristic of local/regional climate data as response variable. GCM data is spatial and temporal. It is curse of dimensionality that can cause spatial correlation between data on different grids in one domain. Therefore, it is necessary to do pre-data processing in arranging of SD model by reducing the dimension of GCM data. An alternative method that can be used to reduce dimension of GCM data factor analysis which is based on principal component analysis. After that, it is done regression analysis with certain method. In this case, it is used Kernel nonparametric regression method because climate variable is generally non-normal, non-linear, and non-stationery. Kannan and Ghoss [2] said that this method can explain temporal variance and extreme value of climate data.

2. Materials and Methods

This research use two kind of data. The first is monthly temperature data from Selaparang rainfall observation station in Lombok Island. The second is monthly air temperature GCM data from CMAP data. The domain of GCM data is 5X5 domain on the Lombok Island. The data collected are data on latitude -2.50° , -5.00° , -7.50° , -10.00° , -12.50° N, and *longitude* 112.50° , 115.00° , 117.50° , 120.00° , and 122.50° E. The data collected are data of 15, 20, 25, and 30 years.

The research will construct model of temperature in Lombok Island using statistical downscaling method with nonparametric Kernel regression approach. Response variable was monthly temperature at station Selaparang and predictor variable was monthly precipitation air temperature GCM data. Before modeling process, pre-data processing of GCM data was done by reducing the dimension of data. The method used was factor analysis. By this method, it will obtained the dominant GCM variable that influence response variable. The dominant variable will be used in statistical downscaling modeling by Kernel nonparametric regression.

Hardle and Muller [2] give the steps of Kernel nonparametric regression

- 1) To obtain Nadaraya-Watson estimator,

$$\hat{m}_H(x) = \frac{\sum_{t=1}^T K_H(X_t - x)Y_t}{\sum_{t=1}^T K_H(X_t - x)} \quad (1)$$

with Gaussian Kernel function $K(u) = \frac{1}{(2f)^{1/2}} \text{Exp}\left(-\frac{1}{2}u^2\right)$, $-1 \leq u \leq 1$

- 2) To obtain optimum bandwidth based on generalized cross validation (GCV) criteria. Bandwidth optimum is bandwidth that minimize GCV function.

$$GCV = \frac{n^{-1} \sum_{t=1}^n (Y_t - \hat{m}_H(X_t))^2}{(n^{-1} \text{trace}(\mathbf{I} - \mathbf{H}(h_0)))^2} \quad (3)$$

- 3) To obtain the best of Kernel nonparametric regression model with optimum bandwidth

3. Results and Discussion

By factor analysis, the 15 years data of air temperature GCM is extracted into two factors (factor 1 and factor2) with 93.639% total variance explained. Variables of GCM data are classified into the factors based on correlation score of each variable to the factors. For example, variable which has high correlation score to factor 1 will be element of factor 1. The extraction by factor analysis can reduce dimension of data from 25 variable into smaller number of variables.

Factor 1 explain variance more than factor 2, that is 78.62%. So, variables included in factor 1 are more dominant to obtain variance of data than variables in factor 2 and GCM data can be projected onto these variable. Among variables in factor 1, variable X_4Y_2 (CMAP air temperature data on grid -10° N and 115° E) have the highest score of correlation to factor 1. So, it is the most dominant variable affecting factor 1 and can be the projection of the 15 years data of air temperature GCM. The same analysis was performed on data 20, 25, and 30 years. The result are summarized in Table 1.

Table 1. Summary of projection result by factor analysis

Periode Data	Number of factor	Total variance explained (%)	Dominant variable	Correlation score to factor
15	2	93.639	X ₄ Y ₂	0.942
20	2	92.223	X ₅ Y ₂	0.95
25	2	93.356	X ₅ Y ₃	0.949
30	2	92.808	X ₅ Y ₂	0.944

Based on Table 1, more analysis about the predictor variabel describe that the most dominant variable of 15 years data is variable X₄Y₂ (CMAP air temperature data on grid -10° N and 115° E), the dominant variable of 25 years data is variable X₅Y₃ (CMAP air temperature data on grid -12.5° N and 117.5° E), also the dominant variable of 20 and 30 years data are variable X₅Y₂ (CMAP air temperature data on grid -12.5° N and 115° E). The variables may used to be predictor that have low complexity. Then, it is done modeling of temperatur by Kernel nonparametric regression, with projection variable as predictor and local temperature as respon variable. The result are shown on Figure 1.

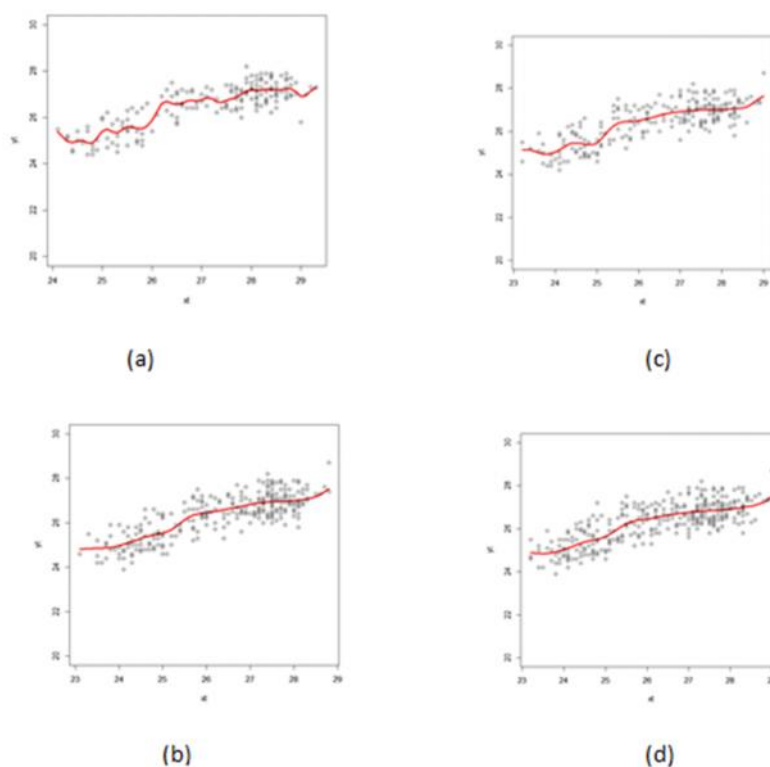

Figure 1. Model of temperature in Selaparang Lombok for 15 years data (a), 20 years data (b), 25 years data (c), and 30 years data (d)

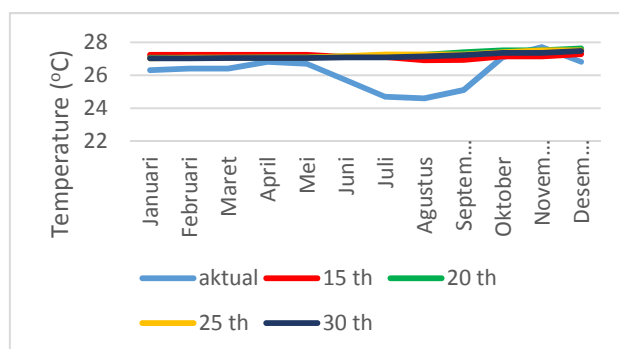

Figure 2. The pattern of actual and prediction temperature in Selaparang Lombok in 2015 based on 15, 20, 25, and 30 years data

Based on the model obtained, it is made predictions of monthly temperature in Selaparang Lombok in 2015. The pattern of temperature predictions is described on Figure 2. Figure 2 shows that the actual temperature and the predictions have small differences on January until May and October until December. Also, the predictions based on 15, 20, 25, and 30 years data are relatively equal. It shows that there is consistency in predictions.

4. Conclusion

Based on the result of this research, it can be concluded that the dimension of GCM data can be reduced by factor analysis. And, statistical downscaling model of temperature obtained using Kernel nonparametric regression gives relatively equal prediction pattern. It shows there is consistency of prediction using four different data periods.

References

- [1] A.H. Wigena, "Pemodelan *Statistical Downscaling* dengan Regresi *Projection Pursuit* untuk Peramalan Curah Hujan Bulanan: Kasus Curah Hujan Bulanan di Indramayu", Disertasi Pascasarjana, IPB, 2006.
- [2] S. Kannan and S. Ghosh, "A Nonparametric Kernel Regression Model for Downscaling Multisite Daily Precipitation in The Mahanadi Basin". *Water Resources Research*, **49**. 2013.
- [3] W. Hardle and M. Muller, (). *Multivariate and Semiparametric Regression*. <<http://www.edoc.hu-berlin.de/series/sfb-373-papers/1997-26/PDF/26.pdf>>. 1997, 26-4-2013

Preliminary Study and Synthesis Thin Film of Antimony Tin Oxide (ATO) with Sol-Gel Spin Coating Technique

Syifa Azzahra^{1*}, Aris Doyan¹, Susilawati¹, Ahmad Harjono¹, Norma Ikraman¹, Zahid Ramdhan¹

*Master of Science education, Post Graduate Mataram University
Lombok Indonesia¹²*

**syifasarahzahra138@gmail.com*

Abstract

ATO tin films has been applied to the device optoelectronics, electronics, sensor and Laser UV. In this research have been synthesized a thin film of Antimony Tin Oxide (ATO) on a glass substrate by sol-gel spin coating technique using centrifuges. To making Sol-gel, this study using material salt of Tin (II) chloride dihydrate ($\text{SnCl}_2 \cdot 2\text{H}_2\text{O}$), ethanol ($\text{C}_2\text{H}_5\text{OH}$), and Antimony (III) Chloride (SbCl_3), each of which serves as solutes and solvents. As the material sol, $\text{SnCl}_2 \cdot 2\text{H}_2\text{O}$ salt dissolved in ethanol solution, at room temperature with stirred using a magnetic stirrer for three hours until completely dissolved with various percent doped antimony on tin oxide is 0, 5, 10, and 15%. In preparation dripped glass sol-gel material is approximately 0.05 ml, then spin using centrifuged for 30 second with rotation speed of 3000 rpm. Then the samples were heated in 350 °C for 10 minute to deposited films.

Keywords: *ATO, sol-gel technique*

1. Introduction

Tin Oxide is one of the material semiconductor that applications as solar cells, optoelectronic device, thin film resistors, antireflection coating, photochemical devices and electrically conductive glass. These properties are attracted the attention of scientist who have attempted to improve electrical performance by different experimental and simulated and methods [1,2]. For TCO application, in electronics for instance, a very high quality of the films is required, and we will show that high quality tin oxide layers, as far as the structure and morphology are concerned [3].

Semiconducting thin films of Tin oxide is usually “n” type and transparent in visible range which can be conductivite by contribution of some elements such as antimony, molybdenum [4,5]

A thin film of pure tin oxide or tin oxide by doping have been generated through a variety of different techniques, such as chemical vapor deposition (CVD), aerosol pyrolysis, sputtering, laser abration, dip coating and sol-gel spin coating. All of these techniques have advantages and disadvantages of each. Some of them need the equipment and how to work more complicated such as high pressure and vacuum conditions. For example, by sputtering method, adhesion between the film and the substrate is good, but it requires complicated equipment. While evaporation method, apparatus used is quite simple, but the outboard power atoms on the substrate surface is not too strong [6].

In previous studies have been quite many conducted research on doping antimony tin oxide such as investigated the characteristics of antimony doped tin oxide thin films by dip coating technique [7], discussed in proceeding that tin oxide cristaline structure remain the same after antimony addition [8], investigation of the properties of antimony doping on tin oxide materials for technological applications [9], and investigate the cristallinity,

microstructure, electrical properties [10].

The current study to synthesis and analyze various percent doped antimony on tin oxide and repeated the process of spin coating and heating. The various percent doped antimony on thin film of tin oxide is 0, 5, 10, and 15% whereas repeated the process of spin coating and heating is once, twice and three times. The purpose of this study were synthesize thin films of Tin Oxide, analyze the effect various percent doped antimony on thin film of tin oxide and repeated the process of spin coating and heating?

2. Materials and Methods

The substrate materials to use glass slide with dimensions (20 mm x 20 mm x 5 mm) were cleaned with two steps. Cleaned glass slide aims to remove oil and organic residues, which appear on glass surface. Step first of cleaned, the glass substrate in warm acetone bath for 10 minutes then remove and place in methanol for 5 minutes. Next, remove and rinse in aquades then dried by blower. Step second of cleaned, pour the aquades and 30% HCl solution. Futhermore, put the glass substrate into glass beaker and shake for 30 minutes then rinse in aquades and dry with blower. The glass substrate that is clean, then stored in plastic clip.

The precursor was prepared using SnCl₂·2H₂O (98%, Merck Co. Inc.) and SbCl₃ (99%, Merck Co. Inc.) as starting materials, and ethanol (99%, Merck Co. Inc.) was used as a solvent. The mixture was stirred for 3 hours at room temperature, to obtain a homogene solution with 1.0 M sol concentration. In this experiment, the solution of sol-gel with various percent doped antimony is 0, 5, 10, and 15%. Then maturation process of sol gel solution approximately one day.

The sol gel materials were deposited on a glass substrate with driped 0.05 ml. Using a centrifuges, spin coating method with a rotation speed of 3000 rpm for 30 seconds. The as-deposited films were heating for 5 minutes on temperature 350°C. In this study, the process of spin coating and heating with various repeated is once, twice and three times.

3. Result And Discussion

Materials used in research synthesis of Tin Oxide salt with a thin layer of sol-gel method that is: Salt tin (II) chloride dehydrate (SnCl₂·4H₂O) with M = 225,53 g/mol, Ethanol C₂H₅OH with M = 46,07 g/mol and Salt antimony (III) chloride (SbCl₃) with M = 228,1 g/mol.

The work was performed in a clean room and room temperature which hydrolysis and condensation reaction as follows respectively:

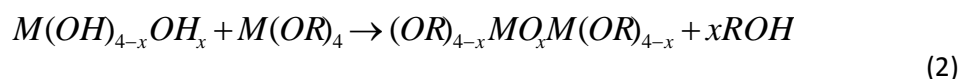
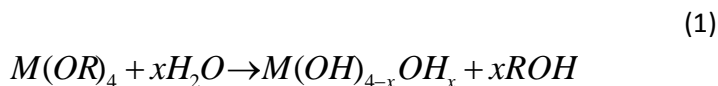

Solution of sol-gel with various percent doped antimony that have been synthesized are stored in small bottles as figure 1.

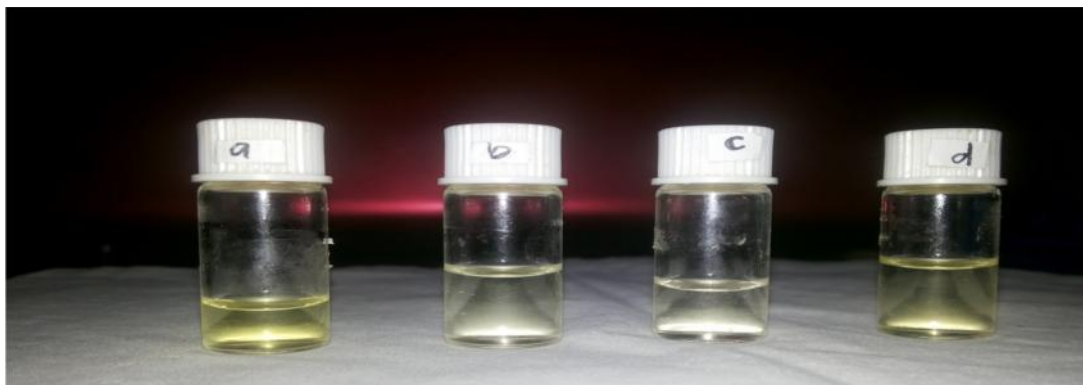

Figure 1. Solution of sol-gel-varying doping antimony a (0%), b (5%), c (10%) and d (15%)

For result deposition solution of sol-gel-varying doping antimony on the glass substrate as figure 2.

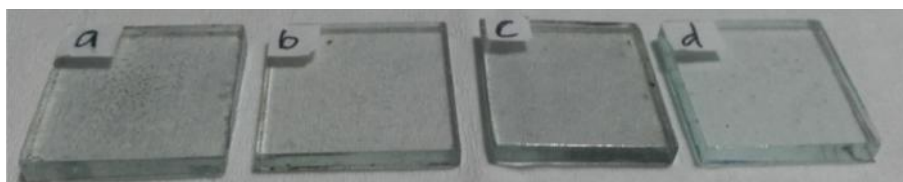

Figure 2. Results deposition solution of sol-gel-varying doping antimony a (0%), b (5%), c (10%) and d (15%) for heating 350 °C

Furthermore the result deposition doping antimony D (15%) with various repeated the process of spin coating and heating 350 °C as figure 3.

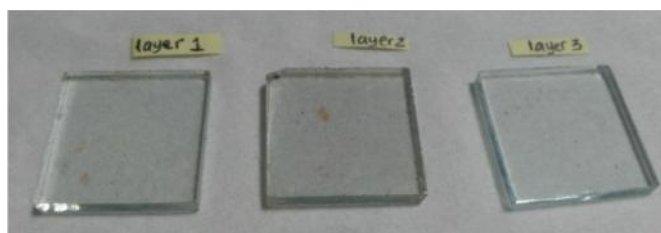

Figure 3. Results deposition solution doping antimony D (15%) with various repeated the process of spin coating and heating 350 °C : (layer 1) once, (layer 2) twice and (layer 3) three times

4. Conclusion

This research have been synthesized a thin film of tin oxide on glass slide by technique os sol-gel spin coating. To making sol-gel, used base material such as salt tin (II) chloride dehydrate (material prekursor) and ethanol, each of which serves as solutes and solvent. As the material sol, $\text{SnCl}_2 \cdot 2\text{H}_2\text{O}$ salt dissolved in ethanol solution, at room temperature with stirred using a magnetic stirrer for three hours until completely dissolved with various percent doped antimony on tin oxide is 0, 5, 10, and 15%. In preparation dripped glass sol-gel

material is approximately 0.05 ml, then spin using centrifuged for 30 second with rotation speed of 3000 rpm. Then the samples were heated in 350 °C for 10 minute to deposited films.

References

- [1] Chien-Kun Wang et al. 2010 *Journal of Marine Sciences and Technology* 18 225
- [2] Z. Chelahi Chikr et al. 2013 *Surface Review Letter* 20 1250050
- [3] J. Pchatelon et al. 1994. *Thin Solid Films* 247 162
- [4] Terrier. C et al. 1995. *Thin Solid Films* 263 37
- [5] Zum Felde et al 2000. *J. Phys. Chem. B* 104 9388
- [6] Erni, T. 2007. Deposisi Lapisan Tipis Aluminium (Al) pada Substrat Kaca dengan Teknik Evaporasi dan Karakterisasi Optiknya. Yogyakarta : Universitas Sanata Dharma.
- [7] T. M,Hammad, and N.K, Hejazy 2011 Structural, Electrical and Optical Properties of ATO Thin Films Fabricated by Dip Coating Method, *Int. Nano Lett.*, 1 2
- [8] Novinrooz, Abdojavad; Parvin Sarabani; Javad Garousi 2006 Iran. *J Chem. Eng.* 25 2
- [9] Z.Hachoum et al. 2016 *Materials Science and Engineering* 123
- [10] Dong Chan woo et al. 2012 *Transactions on Electrical and Electronic Materials* 13 5

The Identification on Iron Compound of Nature Sand in Ampenan Beach Mataram

Annisa Fithriyani^{1*}, Husniatul Khair¹, Susilawati¹, Aris Doyan¹

¹*Master of Science Education, Post Graduate, Mataram University
Lombok, West Nusa Tenggara, Indonesia
email: annisafithriyani@unram.ac.id

Abstract

The research was conducted on the nature sand of Ampenan Beach, Mataram City to determine the percentage of metal content of iron (Fe) which is will be used as a basic ingredient in the synthesis of Barium M-Hexaferrites. Iron sand is sediment containing magnetite (Fe_3O_4), maghemite (Fe_2O_3) and hematite (Fe_2O_3) as major minerals and some other mineral which is the mineral support. Magnetic separation of the natural sand using a permanent magnet has successfully separate the parts are magnetic (iron sand) and non-magnetic. To get extraction, the iron sand can be executed by destruction with concentrated acid ($\text{HNO}_3 + \text{HClO}_4$). Extraction and analyzed by using Atomic Absorption Spectrophotometry (AAS) which show that the iron sands contain metals amounted to 11.15% Fe.

Keywords: *Fe, nature sand, Atomic Absorption Spectrophotometry*

1. Introduction

Sand is a natural ingredient that is very abundant in Indonesia. Natural sand contains many valuable minerals containing elements iron, titanium, and other elements that can be utilized for industrial materials [1]. Potential and distribution of ore iron in Indonesia are often found in various area such as: the west coast of Sumatra, southern coast of Java, Borneo, Sulawesi, Nusa Tenggara, and Maluku Islands, but so far the exploration activities not been done fully and systematically [2]. Research that has been done previously found that 60.8% of natural sandstone contain magnetic minerals [2] with a metal content of iron (Fe) about 87.5% [3]. Separation of magnetic minerals are managed to separate the parts of magnetic (ore iron) and non-magnetic [4]. Magnetic mineral separation process can use a permanent magnet (magnetic separator) [5].

Sand iron compounds contain magnetite (Fe_3O_4) [1,3,6,7], hematite (Fe_2O_3) [3,4,6,8] as the main minerals (predominantly compound) and maghemite (Fe_2O_3), silica (SiO_2) [1,3,4,6,7], alumina (Al_2O_3), rutile (TiO_2) [4,7], and ilmenite (FeTiO_3) [6] as a minor compound. The differences levels of mineral content due to geological structure and mineralization processes in each region. These minerals are magnetic 88% and 12% do not have magnetic properties [3]. These minerals have the potential to be developed as an industrial material. For example, magnetite can be used as a base material dry ink (toner) on a copier and laser printer [3], in industries such as ceramics, catalysts, energy storage, magnetic data storage device, Ferro fluid, as well as in medical diagnostics [9], absorbing radar waves [10]. The maghemite is the key ingredient of a tape [1].

Natural sand contained in the beach also comes from the river. Natural sand in the river has similar physical appearance with natural sand at the beach. The sand river also have a sand iron and mineral content similar to the natural sand beach. Based on research that has been done before it is known that the average percentage of iron sand from the river sand is

smaller compared to the average percentage of iron sand from the sand beach, with the main minerals are *albite* (NaAlSi₃O₈) [1].

This study examined the content of iron (Fe) in natural sand by using equipment Atomic Absorption Spectrophotometry (AAS). This test aims to determine the amount and presentation of the mineral content of iron (Fe) in natural sand to be used as raw material in the synthesis of microwave absorbing materials are Barium M-Hexaferrites (BAM).

2. Materials and Methods

The equipment used in this study such as measuring cups, pumpkin destruction, filter paper, funnel, pipette, spatula, analytical balance, magnets neodymium, heating, test tubes, test tube rack, flask, micro pipette. The basic ingredients we used in this study is taken from the natural sand Ampenan Beach, Lombok near the mouth of the river. Solution of HNO₃ and HClO₄ used in wet destruction process, and distilled water as a solvent when dilution. The measurement of magnetic mineral content aims to determine the percentage content of magnetic minerals that contained in natural sand. Measurements has made with a permanent magnet in a way closer to the natural sand. Iron sand that sticks to the magnet is a magnetic mineral. The percentage of magnetic minerals can be calculated using equation 1 [2]:

$$MM(\%) = \frac{\text{magnetic materials mass}}{\text{total mass}} \times 100 \% \quad (1)$$

The process of testing the metal content of iron (Fe) can be seen in the following flowchart (Figure 1):

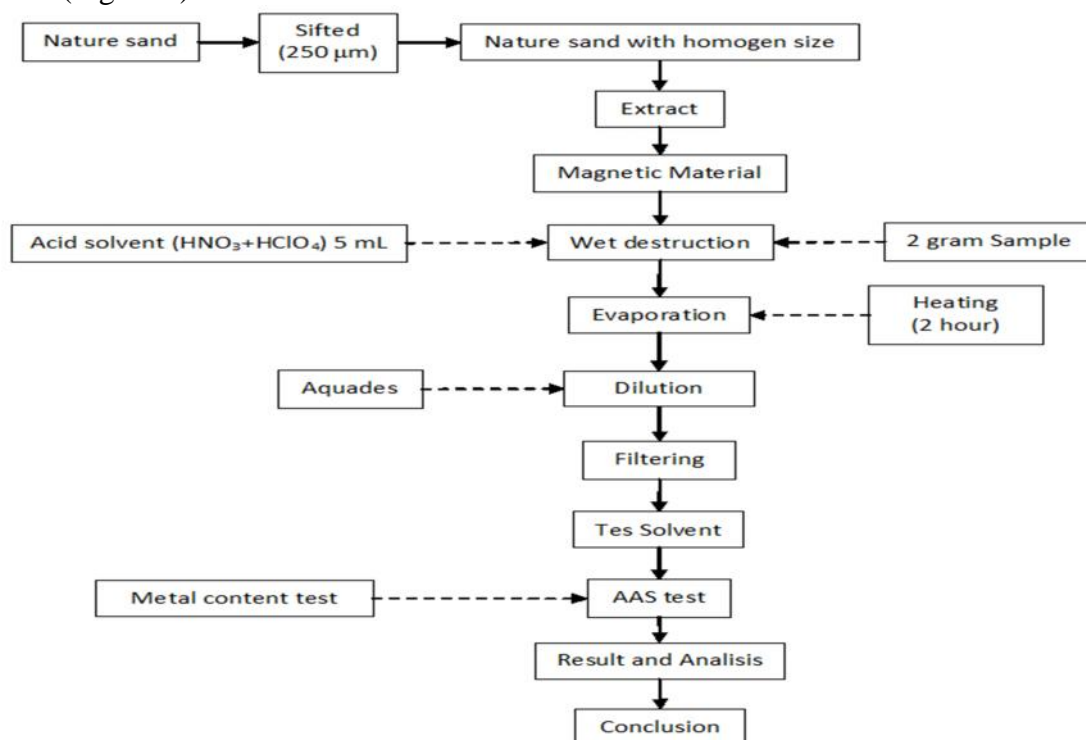

Figure 1. The flowchart of identification iron in nature sand using AAS

3. Results and Discussion

Iron sands extraction of natural sand by using a permanent magnet powered 1.48T showed that 50 grams of natural sand (Figure 2a) were homogenized using a sieve size of 250 μm and have 24 grams of magnetic minerals (Figure 2b), or there are about 47, 21% of magnetic minerals in the natural sand.



Figure 2. The homogen nature sand (a); the magnetic minerals (b)

Then analyzed using AAS to determine the metal content of iron (Fe) and obtained the data as shown in the tables below:

Table 1 Result of AAS Analyte

		Analyte	Mean
1	Fe-I	Fe 305.91	44.24 mg/L
2	Fe-II	Fe 305.91	46.09 mg/L
3	BLK	Fe 305.91	-0.406 mg/L

Table 2. Result of Iron Percentace

		Content of Metal (ppm)	Percentace (%)
1	Fe-I	109.067,600	10,9068
2	Fe-II	113.898,0872	11,3898

4. Conclusion

Based on the results of the research that has been done, the iron sand successfully extracted using permanent magnets obtained by percentage of magnetic minerals by 47.21% in 50 grams of natural sand. Test analysis of metal content of iron (Fe) in mineral obtained by using AAS showed that the samples of Fe-I are 109,067.600 ppm Fe with a percentage of 10.9068% and the Fe-II samples contained metal 113,898.0872 ppm Fe percentage of 11.3898%. The average percentage of Fe in both samples is 11.1483%. This amount can be quite high.

5. Acknowledgments

This research, have been sponsorship by PUPT research of Departemen Reaserch and Technology 2016. Thank you very much to Mataram University Research Center for helping at administration procedure. Futhermore thank giving to Analytic Laboratorium Mataram University and LIPI Serpong Jakarta.

References

- [1] Afdal and L. Niarti, 2013, Characterization of Magnetic Properties and Mineral Content Iron Sand BatangRiver Kuranji Padang, West Sumatra, Journal of Physical Science5(1), pp. 24-30.
- [2] F. Rozidan A. Budiman, 2015, Effect of Temperature Variation toward the Grains Form Magnetic Mineral of Iron Sand Mineral grains, Journal of Physics Unand4(2), pp. 123-128.
- [3] Ratnawulan, 2013, Characterization of Nature Iron Ore as Raw Materials Magnetite of the Dry Ink, Journal of Science and Mathematics6(1).
- [4] A. Ibrahim, I. Yusuf, danAzwar, 2012, Identification of Metal Compounds in Iron Sand in Aceh Province, Scientific Magazine BISSOTEK7(1), pp. 44-51.
- [5] N. D. Anggraini, 2008, Analysis of SEM (Scanning Electron Microscopy) in Oxidation Process Monitoring Magnetite become Hematite, National Seminar-IIV Engineering and Mechanical Engineering Applications

- in Industry Campus ITENASISSN 1693-3168.
- [6] Zulkarnain, 2000, Possible Utilization of Iron Sand Coastal Aceh for Magnet Fabrication, Proceedings of the National Seminar IMagnet Material, Serpong, October 11, 2000, ISSN 1411-7630, pp.59-61.
 - [7] Z. Jalil, E.N. Sari, Ismail, dan E. Handoko, 2014, Study Phase Composition and Properties of Iron Sand Magnetism Aceh Coastal Separation using Mechanical Milling Method, Indonesian Journal of Applied Physics 4(1), pp. 110-114.
 - [8] D. L. Kartika dan S. Pratapa, 2014, Synthesis Fe₂O₃ of Iron Sand with Hydrochloric Acid Dissolved Metal Method, Journal of Science and Arts Pomits 3(2), pp. B-33 – B-35.
 - [9] L. K. Sholihah, 2010, Synthesis and Characterization of Fe₃O₄ Nano Particles Originating from Iron Sand and Fe₃O₄ Materials Commercial (Aldrich), ITS Journal
 - [10] R. L. Sari dan Mashuri, 2010, Composites Epoxy-Fe₃O₄ as Radar Absorbent Materials at Frequency 8 to 12.4 GHz

Preliminary Study of Electrical and Magnetic Properties of Barium M-Hexaferrites from Nature Sand With Co-Ni Substituted by Co-Precipitation

Husniatul Khair^{1*}, Annisa Fithriyani,¹, Susilawati¹, Kosim¹, Aris Doyan¹

¹*Master of Science Education, Post Graduate, Mataram University,
Lombok, West Nusa Tenggara, Indonesia*

**email: husniatul.khair@gmail.com*

Abstract

Barium M-hexaferrites (BaM) for several decades became an interest topic for researchers because it has a saturation magnetization, coercivity, and a high curie temperature with magnetic and electrical properties can be adjusted to suit the application required. For reducing the magnetic properties from hard magnetic to soft magnetic need substitution or doping there for BaM with doped by Co-Ni ions can be a potential candidate as a microwave absorbing materials. Based on that, the researchers do a preliminary research to determine the electrical and magnetic properties of BaM doped by Co-Ni ions. BaM will be synthesis from iron which is separation from nature sand. The synthesis method in this research is co-precipitation with variation of doping concentration and calcinations temperature. To know the electrical and magnetic properties will be using x-ray diffraction (XRD) to identify phases; Scanning Electron Microscopy (SEM) to identify the distribution of elements contained and the percentage of each element; Transmission Electron Microscope (TEM) to ascertain the particle size has reached the order of nano; LCR Meter to get the electrical properties as conductivity samples; Vibrating sample Magnetometer (VSM) to get the magnetic properties (magnetic saturation, coercivity and magnetic remanence); and Vector Network Analyzer (VNA) will show that the intensity of the microwaves that can be absorbed.

Keywords: *Barium M-hexaferrites, natur sand, Co-Ni doped, co-precipitation, microwave absorber*

1. Introduction

The electromagnetic waves have been used in various fields such as in the fields of electronics, telecommunications, and information. The impact of rapid development are various systems based equipment electronics such as electronic control system and security system equipment that are vital even human safety and health are now facing a new threat that comes from the atmosphere which known as the Electromagnetic Interferences (EMI) [1]. The Electromagnetic Interference pollution that affects human life, make microwave absorbing material as an important topic to study. One material that can be used as a microwave absorbing material is Barium M-Hexaferrites (BaM).

BaM is a permanent magnet with the main composition elements of ferrites (Fe) as the base material synthesis, where the element iron is obtained by extracting the sand that containing iron. In Lombok Island with 2,333 km coastline which is long enough to have sand that containing iron potential to be developed. The utilization of sand that containing irons is currently less optimal because it was only used asan mixture of cement. Sand that containing iron, have Fe oxides component such as magnetite (Fe₃O₄), maghemite (γ- Fe₂O₃) and hematite (α- Fe₂O₃) that have the potential to be processed into a variety of products with a higher economic value. One of the place that potential as a source to obtain thesand that

containing iron on the Lombok islands is Ampenanbeach. Based on preliminary research that we've done, the Fe content provided quite high at 11.15%. Therefore, that was potential to be used as a microwave absorbing material.

BaM was applied as an absorbent material data recorder and microwave. The BaM has a high saturation magnetization (78 emu/g), field coercivity is large (6700 Oe), a high temperature Curie (450°C), good chemical stability and corrosion resistance, with electrical and magnetic properties that can be set to suit the application required [2]. However, the high of magnetic field (coercivity field) causes BaM have weak absorption properties making it less effective as the microwave absorbing material. To solve these problems it is necessary to substitute or doping Fe³⁺ ions with other metal cations whose sized is almost the same (Al³⁺, Ga³⁺, and Cr³⁺) [3], in order to lower the magnetic properties of BaM from hard magnetic to be soft magnetic. There are two approaches to substitution ionic, commonly used is the approach of using a single ion substitution and using multiple ion substitution. Substitution double ion is a popular method in the study of BaM, and a number of studies have been undertaken to modify the properties of the magnetic as the use of double ion (Mn-Ti, Co-Ti, Ni-Ti and Zn-Ti) [4], Co-Zn and Ni-Zn [5], as well as the Co-Mn [6]. The substitution that was performed in this study used a combination of elements of transition metal is Co-Ni, because both of these elements has a radius and configuration of the ionic similar to Fe³⁺ (ionic radius Fe = 0.077 nm; Co = 0.072; and Ni = 0.069). It was found that substitution of Co ions can significantly lower the saturation magnetization of 5 emu/g at x = 1.0 with calcination temperature of 800°C [7], whereas Ni ion substitution can significantly lower the coercivity field of 0.05 T at x = 0.7 with calcination temperature of 800°C [8].

There are different methods used in the synthesis of BaM such as solid state reaction [9], ball milling [10], sol-gel [11], and co-precipitation [12]. In this study we used co-precipitation method (co-precipitation). The advantages of this method are, used low temperatures and it was easy to control the particle size so the time that required is shorter. The products are expected to have a smaller particle size and more homogeneous than solid state method and sol-gel method [13]. Based on the description, the focus of this study were to synthesized and characterization of electrical and magnetic properties of BaM that will use as a microwave absorbing materials based on natural sand with varying the doping concentration of Co-Ni and calcination temperature. In this article, we only delivered about synthesized BaM with Fe from nature sand as a basic component.

2. Materials and Methods

The initial step in this research is to prepare raw materials used in the synthesis of BaM such as: BaCO₃, doping Co and Ni, and Fe₃O₄ were synthesized from Ampenan beach sand with co-precipitation method. Solvents used were 12.063 M HCl, 6.5 M NH₄OH and aquadest. Generally there are 5 stages to be carried out as follows: First, sand that containing iron separation using permanent magnets with the aim to separate the magnetic material from impurities. The Second is to identification the percentage of Fe content using Atomic Absorption Spectrophotometry (AAS). Third, the synthesis of Fe₃O₄, by extracting Fe which dissolved in HCl in the ratio extracts of sand that containing Fe with solvent 3:8 while stirring and heated with magnetic stirrer and then precipitated with NH₄OH in the ratio 1: 5 and then dried in an oven with a sintering temperature of 100°C for 4 hour. Fourth, Synthesis BaM by varying the doping concentration of Co-Ni (x = 0.0; 0.2; 0.4; 0.6; 0.8; and 1.0) and variations of calcinations temperature (T=400°C, 600°C, 800°C, and 1000°C). The Fifth is characterization using XRD, SEM, TEM, LCR-meter, VSM, and VNA.

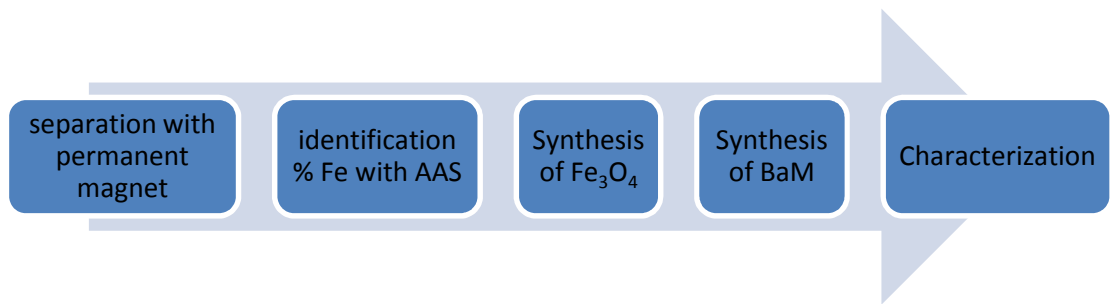

Figure 1. The flowchart of BaM synthesis process using co-precipitation method

3. Results and Discussion

The results of the separation sand that containing Fe (Figure 2a) was dissolved in HCl solution to produce the compounds according to the following reaction:



Based on the results of these reactions, there are ions Fe^{2+} and Fe^{3+} which play a role in the synthesis of Fe_3O_4 . The formation of nanoparticles carried by precipitation with an alkaline solution NH_4OH with the following equation:

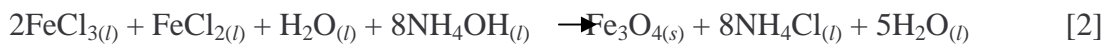

Black precipitate will form immediately when the first reaction of the resulting solution is mixed with an alkaline solution, filtered and then dried using an oven in order to obtain a very fine Fe_3O_4 powder (Figure 2b). This reaction was happen very quickly that cause the formation of nano-sized Fe_3O_4 particles [14]. In the synthesized of pure BaM (without doping), Fe_3O_4 reacted with BaCO_3 and precipitated with NH_4OH corresponding reaction equation as follows:

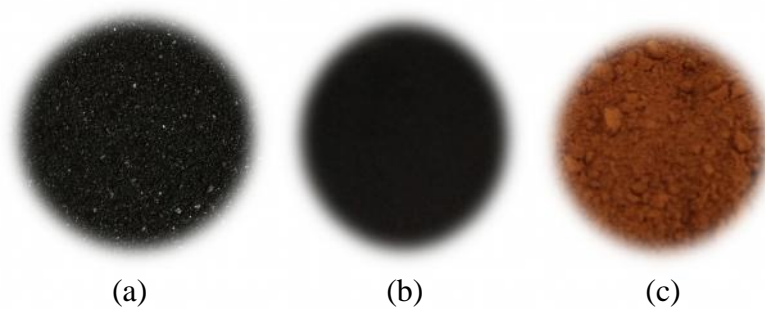
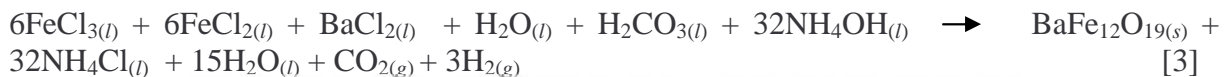

Figure 2. (a). sand that containing iron, (b). Fe_3O_4 powders, (c). BaM powders ($\text{BaFe}_{12}\text{O}_{19}$)

Based on the reaction was obtained 5 grams $\text{BaFe}_{12}\text{O}_{19}$ powder (Figure 2c) then performed the characterization to determine the properties of electricity and magnetism samples using LCR-meter and VSM.

4. Conclusion

BaM has been created based sand that containing iron from Ampenan beach sand synthesized using co-precipitation method, then it were characterized to determine the nature of electrical and magnetic properties samples. BaM that formed is applied as a microwave absorbing material.

Acknowledgements

This research has been sponsorship by PUPT research Department of Research and Technology of Higher Education 2016. Thanks you very much to Mataram University Research Center for helping on all the administration procedure. Furthermore thank giving to analytic Laboratory of Mataram University.

References

- [1] W. D. Laksanawati, B. Kurniawan, dan S. A. Saptari: Synthesis Nano Material of Perovskite $\text{La}_{0,67}\text{Sr}_{0,33}\text{Mn}_{1-x}\text{Ni}_x\text{O}_3$ ($x=0, 2 \& 0, 25$) with sol gel Method. *Omega: Jurnal Fisika dan Pendidikan Fisika*, 2(1), 25-27(2016).
- [2] I. N. Saidah, dan M. Zainuri: Pengaruh Variasi pH Pelarut HCl Pada Sintesis Barium M-Hexaferrit Dengan Doping Zn ($\text{BaFe}_{11}\text{Zn}_4\text{O}_{19}$) Menggunakan Metode Kopresipitasi. *Jurnal Sains dan Seni ITS*, 1(1), B41-B46 (2012).
- [3] D. A. Vinnik, D. A. Zherebtsov, L. S. Mashkovtseva, S. Nemrava, M. Bischoff, N. S. Perov, and R. Niewa: Growth, structural and magnetic characterization of Al-substituted barium hexaferrite single crystals. *Journal of Alloys and Compounds*, 615, 1043-1046 (2014).
- [4] H. Sözeri, H. Deligöz, H. Kavas, and A. Baykal: Magnetic, dielectric and microwave properties of M-Ti substituted barium hexaferrites ($M = \text{Mn}^{2+}, \text{Co}^{2+}, \text{Cu}^{2+}, \text{Ni}^{2+}, \text{Zn}^{2+}$). *Ceramics International*, 40(6), 8645-8657 (2014).
- [5] R. Agustianto, and W. Widyastuti: Fraksi Mol Dan Variasi Ph Terhadap Sifat Magnetik Dan Struktur Mikro Barium Hexaferrit Dengan Metode Sol-Gel Auto Combustion. *Jurnal Teknik ITS*, 3(1), F108-F112 (2014).
- [6] A. Doyan, S. Susilawati, dan S. Sahlam: Karakterisasi Barium M-Hexaferrit Substitusi Logam Co-Mn menggunakan Spektroskopi Fourier Transform Infra Red. Prosiding Seminar Nasional Fisika (2015).
- [7] S. Susilawati, K. Khairunnisa, dan A. Doyan: Sintesis Bahan M-Hexaferrites dengan Doping Logam Co Menggunakan FTIR. *Jurnal Pendidikan Fisika Dan Teknologi*, 1(3) (2015).
- [8] S. Susilawati, A. Doyan, and M. Munib: Synthesis by co-precipitation method and characterization of Nickel-doped Barium M-Hexaferrite ($\text{BaFe}_{12}\text{O}_{19}$). Proceeding ICMSE ISBN 9786021570425 (2015).
- [9] J. Li, H. Zhang, V. G. Harris, Y. Liao, and Y. Liu: Ni-Ti equiatomic co-substitution of hexagonal M-type $\text{Ba}(\text{NiTi})_x\text{Fe}_{12-2x}\text{O}_{19}$ ferrites. *Journal of Alloys and Compounds*, 649, 782-787 (2015).
- [10] S. H. Mahmood, A. N. Aloqaily, Y. Maswadeh, A. Awadallah, I. Bsoul, M. Awawdeh, and H. Juwhari: Effects of Heat Treatment on the Phase Evolution, Structural, and Magnetic Properties of Mo-Zn Doped M-type Hexaferrites. In *Solid State Phenomena* (Vol. 232, pp. 65-92). Trans Tech Publications. (2015).
- [11] R. Agustianto, and W. Widyastuti: Fraksi Mol Dan Variasi Ph Terhadap Sifat Magnetik Dan Struktur Mikro Barium Hexaferrit Dengan Metode Sol-Gel Auto Combustion. *Jurnal Teknik ITS*, 3(1), F108-F112 (2014).
- [12] N. Dawar, M. Chitkara, I. S. Sandhu, J. S. Jolly, and S. Malhotra: Structural, magnetic and dielectric properties of pure and nickel-doped barium nanohexaferrites synthesized using chemical co-precipitation technique. *Cogent Physics*, 3(1), 1208450 (2016).
- [13] K. Velmurugan, V. S. K. Venkatachalapathy, & S. Sendhilnathan: Synthesis of nickel zinc iron nanoparticles by coprecipitation technique. *Materials Research*, 13(3), 299-303(2010).
- [14] L. K. Sholihah: Sintesis dan Karakteristik Partikel Nano Fe_3O_4 yang Berasal Dari Pasir Besi dan Fe_3O_4 Bahan Komersial (Aldrich)(2010).

Agro-tourism in North Lombok Stimulates New Crops and Technology Adaptation, and Farming Becomes Profitable

Taslim Sjah^{1*}, Zainuri², Ahmad Sauqi¹, Jayaputra¹

¹Faculty of Agriculture

²Faculty of Food Technology and Agro Industry

University of Mataram

*Email: t.sjah2@gmail.com

Abstract

North Lombok Regency is currently implementing economic development, including the development of tourism and agriculture. The regency identifies potential locations, followed by implementation of integrated activities in the frame of agro-tourism. The region supplies water through piping and applies appropriate technology to crops that are introduced to the new cropping land. The results indicate that the introduced crops adapt to the new sites, grow well, and bring profit to farmers. The impact of the development of agro-tourism is positive.

Keywords: *Agro-tourism, Appropriate technology, Crop introduction, Farm Profit*

1. Introduction

North Lombok Regency (NLR) has been implementing many policies and programs for developing its region in many aspects. In economic aspect, the regency has top priorities in developing agricultural and tourism sectors, since the region has the potential on these sectors. This direction of development is in line with the national government policies and programs, that are guided in *MP3EI (Masterplan Percepatan dan Perluasan Pembangunan Ekonomi Indonesia, The Plan for acceleration and expansion of economic development in Indonesia)*. West Nusa Tenggara (WNT), where North Lombok is within (BPS NTB, 2016), is included in the corridor of Bali and Nusa Tenggara, with one of the focuses is on tourism (Presiden RI, 2011).

NLR has more than 80 % dry land (BPS Lombok Utara, 2014), and thus the availability of water is critical. Several years ago, ground water wells have been built in many spots in NLR to activate agricultural practices, for being sources of the community income. Since then community have been growing many commodities of agriculture in broad sense, including those of estate crops, food crops, and horticulture. Apart from growing old types of crops, new crops are also introduced to region by agricultural producers, by adapting to the local condition or by manipulating the local conditions to enable crop growing, and by not forgetting economic consideration.

In achieving the goals of tourism, economic, and agriculture for the well being of the people, NLR develops the so called 'agricultural tourism', 'agri-tourism', 'agro-tourism' ('agro-wisata'). Essentially, this type of tourism is developing agriculture for the purpose of providing agricultural beauty for visitors to enjoy. This type of business has been increasing in recent years in Indonesia and other parts of the world. The entrepreneurs of this business maximize profit by exploiting revenue from the crops grown and also from tourism aspect of the activity (Wikipedia, 2016).

In integrating agriculture into tourism, supporting systems need to be included, among others, are suitable irrigation facilities and profiting new crops. Irrigation is required for enabling optimal application of agricultural inputs, particularly seeds and fertilizers. In addition, agricultural producers search for new crops that grow well in the location as well as

have a good price, all of which accumulate to become better profit than ordinary grown crops. This paper describes the impacts of agro-tourism developed in Gumantar Village, Kayangan District, North Lombok Regency

2. Materials and Methods

This study combined quantitative method (Neuman, 1997; Taylor, 2000) and qualitative methods (Neuman, 1997; Patton, 2002; Trumbull, 2000), to provide figures and explanation as needed. This research took place in Gumantar Village, Kayangan District, North Lombok Regency, and was designed to develop tourism with beauty of agriculture that attracts people to visit. The location for crop growing and crops to be grown on the location were discussed by team members. In this early stage of tourism are development, two crops were chosen, i.e. tomato and rock melon. In addition to their beauties, these two crops were considered promising to give good earnings. Furthermore, the location considered suitable for the crops and provides a good view, is asked for agreement from a farmer (farmers). After the farmer agreed to grow the crops, then the farmer is given instruction on how to grow the crops, including how much each input to be applied. He was also asked to record all farm needs and applications, farm production, product price. In particular, investigation team asked the farmer to record application dates and its cost or revenue. The team then copied the record and asked explanations for things considered necessary. These data are complemented with data from secondary sources (Sjah, 2011). Data were analyzed in descriptive way, providing information and understandings (Patton, 2002).

3. Results and Discussions

3.1. Managing resources

This activity is designed for agri-tourism to gain beautifulness or attractiveness and economic profit from crops grown, and others related. The location was selected for the ease of access by travelers, hence road side was chosen. Similarly, water is brought to the location from a source through piping and storage system. The location was (and will be) managed in such way that brings attractiveness and resource use efficiency. Attractiveness invites people to visit, and efficiency in resource use minimize cost. In particular, attractiveness in agricultural products encourages people to buy. All of these are expected to generate profit, one of the main motive in people, including farmers, to behave in certain way.

3.2. Water leads the way to agricultural practice

The traditional practice of agriculture in the area was that mainly to grow corn in most of the land in rainy season. Outside the rainy season, growing crops was inhibited by lack of water for irrigation. Irrigation facility has been introduced to bring water to the area. There are two sources of water for irrigation: springs and ground water. Water from springs is channeled through pipe using gravity. Ground water is brought to the location through pumping system. In addition, water is naturally available during rainy season from rainfalls, although it is limited to the rainy season only.

Since the irrigation water available for the whole year round, farmers have flexibility in growing crops. From one time planting in a year, farmers can now grow crops as they wish during the year. Apart from growing corn, farmers can grow other food crops, vegetables, fruits, or else. In brief, farmers can grow old traditional crops like corn, vegetables, or grow completely new crops.

3.3. New crops introduced

In this beginning period of the development of agro-tourism are, two crops were

introduced. They are tomato and rock melon. The initial planting of tomato was 7 ‘are’ (This is Indonesia term commonly used to measure land, which 1 are = 10 m times 10 m, or 100 m²), while rock melon was 6 ‘are’. As these crops can be said as new crops to the farmers, then the implementing team trains and supervises the growing of the groups to guarantee that the crops will grow well. The team also provides inputs, such as seeds, fertilizers, and pesticides. The work of land processing was also done under supervision of the team. In short, the research team controlled.

3.4. Income from new crops

The two new crops generated the highest farm income according the record attained. Following conversion to hectare (ha) the income obtained from tomato was as much as IDR 233,750,000 and from rock melon was as much as IDR 137,500,000 (Zainuri *et al.* 2016). These incomes were much higher than income from other crops grown in the Province of West Nusa Tenggara, and possibly in Indonesia too. As comparison, incomes from crops grown in Lombok are presented in Table 1.

Table 1. Comparison of incomes from several crops in West Nusa Tenggara Province

Crop	Location	Income per ha (IDR)	Source of information
Tomato	Gumantar	233.750.000	Zainuri <i>et al.</i> (2016)
Rock Melon	Gumantar	137.500.000	Zainuri <i>at al.</i> (2016)
Rock Melon	Central Lombok	109.000.000	Mujianingsih <i>et al.</i> (2015)
Water Melon	Central Lombok	105.000.000	Mujianingsih <i>et al.</i> (2015)
Chili	Mataram	93.000.000	Alis (2016)
Rice	Central Lombok	24.843.954	Wijaya (2016)
Corn	West Lombok	19.752.626	Laksemi (2016)
Rice	West Sumbawa	13.179.046	Ardiansyah (2016)

There are two main reasons for high income from the two crops. Firstly, they have high price. Both tomato and rock melon were produced outside their normal season, when other farmers did not produce. In times of less supply while other factors remained the same, then the price increases (Cramer *et al.*, 2001; McIver, 2001; Penson *et al.*, 2002; Seitz *et al.*, 2002; Sjah, 2010). Secondly, production of the two crops was run in intensive way. Intensification or intensive farming with application of additional inputs is seen as a way to increase agricultural production (Sahidu, 1983; Sari and Sjah, 2016; Savadogo *et al.*, 1998). In particular to these two crop farming, intensification was applied with more organic fertilizers, including manure, granular organic ‘*bioextrim*’ liquid organic (*bomax*, *bioextrim cair*, *hormax*, *bioplant omega*, *hantu*, *super biota plus*), and with more liquid bio pesticides (*biopestisda omega*, *bormax*) (Zainuri *et al.*, 2016). The combination of intensive farming (which lifted productions) and good timing of farming (with increased prices) cause farming of these crops become highly profitable.

4. Conclusions and Recommendations

The development of agro-tourism area in Gumantar Village, Kayangan District, North Lombok Regency brings positive impact. The development advances agriculture and tourism as an integration in agro-tourism, which aims of gaining profit through agricultural production and attractiveness. The crops introduced indeed generated among the highest income on record, which was due to high prices and productions of the newly introduced crops. High prices was a consequence of a good production timing, and high productions were contributed

by highly intensive farming. Intensive farming and out of normal season farming was made possible by the availability of water for irrigation. Such program that has proven as having positive impact is recommended to be continued in that location or elsewhere. This program also brought lesson to be learnt that supervision in farming practices is important to ensure high rate of success.

References

- [1] Alis, W.M.: 2016. *Analisis biaya dan usahatani cabai di Kota Mataram*. Fakultas Pertanian Universitas Mataram, Mataram
- [2] Ardiansyah. 2016. *Analisis komparasi produksi dan pendapatan usahatani padi sebelum dan sesudah adanya Program UPSUS PAJALE di Kecamatan Brang Ene, Kabupaten Sumbawa Barat*. Fakultas Pertanian Universitas Mataram, Mataram.
- [3] BPS Lombok Utara: 2014, *Lombok Utara Dalam Angka 2014 (North Lombok in Figures 2014)*. Badan Pusat Statistik Lombok Utara (Central Body of Statistics of North Lombok), Tanjung.
- [4] BPS NTB: 2016, *Nusa Tenggara Barat Dalam Angka 2015 (West Nusa Tenggara in Figures 2015)*. Badan Pusat Statistik Nusa Tenggara Barat (Central Body of Statistics of West Nusa Tenggara), Mataram.
- [5] Cramer, G. L., Jensen, C. W. and Southgate, D. D. J.: 2001, *Agricultural Economics and Agribusiness*. 8th ed. John Wiley & Sons, New York.
- [6] Laksemi, N.P.: 2016. *Analisis faktor-faktor yang mempengaruhi produksi dan pendapatan usahatani jagung hibrida di Kecamatan Gerung, Kabupaten Lombok Barat*. Fakultas Pertanian Universitas Mataram, Mataram.
- [7] McIver, J.: 2001, *Micro economics*. McGraw-Hill, Roseville, NSW, Australia.
- [8] Mujianingsih, A., Hidayati, A. and Sjah, T.: 2015, 'Analisis Pendapatan dan Penyerapan Tenaga Kerja pada Usahatani Melon dan Semangka di Kabupaten Lombok Tengah (Analysis of income and labor absorption in Rock melon and Water melon farms in Central Lombok).' *Agroteksos* **25**, 131-136.
- [9] Neuman, W. L.: 1997, *Social research methods: Qualitative and quantitative approaches*. Allyn and Bacon, Boston.
- [10] Patton, M. Q.: 2002, *Qualitative research and evaluation methods*. 3 ed. Sage Publications, Thousand Oaks, California.
- [11] Penson, J. B. J., Capps, O. J. and Rosson, C. P. I.: 2002, *Introduction to agricultural economics*. 3rd ed. Prentice Hall, Upper Saddle River, New Jersey.
- [12] Presiden RI: 2011, *Peraturan Presiden Republik Indonesia Nomor 32 Tahun 2011 Tentang Masterplan Percepatan dan Perluasan Pembangunan Ekonomi Indonesia 2011-2025 (Master Plan for Acceleration and Expansion of Indonesia Economic Development 2011-2025)*. Sekretariat Kabinet RI, Jakarta.
- [13] Sahidu, A.: 1983, *Pengantar ilmu pertanian*. Fakultas Pertanian, Universitas Mataram, Mataram.
- [14] Sari, M. and Sjah, T.: 2016, 'Implementation of Special Program of Pajale (Rice, Corn, and Soybean) in Terara District, East Lombok Regency.' *International Research Journal of Management, IT, & Social Sciences (IRJMIS)* **3**, 41-50.
- [15] Savadogo, K., Reardon, T. and Pietola, K.: 1998, 'Adoption of improved land use technologies to increase food security in Burkina Faso: Relating animal traction, productivity, and non-farm income.' *Agricultural Systems* **58**, 441-464.
- [16] Seitz, W. D., Nelson, G. C. and Halcrow, H. G.: 2002, *Economics of resources, agriculture, and food*. 2 ed. McGraw-Hill Series in Agricultural Economics (P. J. Barry, ed.) McGraw-Hill, New York.
- [17] Sjah, T.: 2010, *Ekonomi Pertanian (Agricultural Economics)*. Mataram University Press, Mataram.
- [18] Sjah, T.: 2011, *Metodologi Penelitian Sosial Ekonomi (Research Methodology for Socio Economics)*. Mataram University Press, Mataram.
- [19] Taylor, G. R.: 2000. 'Quantitative research methods', in G. R. Taylor, (ed.), *Integrating quantitative and qualitative methods in research*, University Press of America, Lanham, pp. 69-78.

- [20] Trumbull, M.: 2000. 'Qualitative research methods', in G. R. Taylor, (ed.), Integrating quantitative and qualitative methods in research, University Press of America, Lanham, pp. 79-93.
- [21] Wijaya, A.S.: 2016. Analisis keuntungan dan penyerapan tenaga kerja pada usaha tani padi gogo rancah di Kecamatan Praya Barat, Kabupaten Lombok Tengah. Fakultas Pertanian Universitas Mataram, Mataram.
- [22] Wikipedia: 2016. 'Agritourism', in, Vol. 2016, Wikipedia.
- [23] Zainuri, Sjah, T., Sauqi, A. and Jayaputra: 2016. 'Introduksi Tanaman Baru Di Daerah Agrowisata Desa Gumantar Kecamatan Kayangan Kabupaten Lombok Utara Menguntungkan (New Crop Introduction To Agrotourism Area In Gumantar Village, Kayangan District, North Lombok Regency Is Profitable)', in, Seminar Nasional Pertanian (National Seminar on Agriculture), Faculty of Agriculture University of Mataram, Mataram.

Simulation of the Bubble Gas Detection inside the Fluids based on Transmission and Reflection of Ultrasonic Waves

Firyal Dhiyaul Haqqi¹, Bakti Abdillah¹, Rahadi Wirawan^{1*}, Laili Mardiana¹

¹ Department of Physics, Faculty of Mathematics and Natural Sciences, University of Mataram, Indonesia

* Email: rwirawan@yahoo.co.id

Abstract

The appearance of gas bubbles in veins inside the body is the primary cause of decompression illness. Preliminary research has conducted to develop the gas bubble detection system in the both mediums of water and blood with an oxygen and nitrogen gas bubbles. In this research, we use a computer simulation approach based on the analysis of the ultrasonic signal alteration that was received by the transmission and reflection signal mode. The result shows that the attenuation is caused by the absorption of the medium was very small, which the reduction of the amplitude for the medium of blood and water, respectively 1.1% and 0.012%. The existence of gas bubbles within the medium drives the amplitude reduced by 4% to 5% from the initial amplitude and the intensity percentage that was reflected by the bubbles for the medium of blood is greater than the medium of water. The selected frequency of the ultrasonic signal source influences the ability to detect the diameter of the bubbles

Keywords: *attenuation, gas bubble, ultrasonic wave, simulation.*

1. Introduction

Decompression illness is a condition which is suffered by divers who move fast from the deep-sea with higher ambient pressure to the lower ambient pressure [1]. The condition was indicated by the appearance of gas bubbles which has collected in the body tissues. Gas bubbles can be formed in the whole of the body, and they are also frequently observed in the bloodstream [2]. It can cause potentially fatal effects such as paralysis or even death for the divers. Therefore, early detection of the presence of bubbles in the body is an important in order to avoid its impacts.

During the time, the detection of the presence of bubbles has been done through capacitive method [3] and optic method [4]. Both methods have limitations and less precise when they are applied to detect the bubbles either in the tissues or in the blood stream. The bubble is known as a reflector for the acoustic waves due to the difference in acoustic impedance which is large enough between gas and liquid [5] and ultrasonic waves are mechanical waves which have the largest penetrating power characteristics than other mechanical waves. Based on these characteristics, ultrasonic waves can be applied for bubble detection. Recently, Rahiman was performing a bubble detection test inside a chemical column with a medium of water through the transmission wave measurement system [6]. In this paper, we present the detection system of nitrogen and oxygen bubbles that presence in the water and blood medium using ultrasonic sensor. Simulation approach was conducted to analyze the influence of the bubble to the signal attenuation that received by the detector.

2. Theory

2.1 Medium Attenuation

In the propagation, acoustic waves need a medium. The existence of the medium causes attenuation due to the absorption of wave energy [7]. The attenuated amplitude A_I which caused by the medium with the thickness d is [8]:

$$A_1 = A_0 e^{-\alpha d} \quad (1)$$

where A_0 is an initial amplitude, and α is a attenuation coefficient that depend on the frequency. This coefficient is measured in Nepers per length unit (Np/l) or in decibels per length unit (dB/l) with the conversion factor ($\alpha_{dB/l} = 8.636 \alpha_{Np/l}$). In the liquid medium is influenced by the factors of viscosity and thermal conduction which are described by classical absorption constant (α_c).

$$\alpha_c = \frac{\omega^2 \eta}{2\rho_0 c^3} \left(\frac{4}{3} + \frac{(\gamma-1)}{Pr} \right) \quad (2)$$

where ω is an angular frequency ($2\pi f$), η is viscosity coefficient, γ is the specific heat ratio, Pr is Prandtl number, ρ_0 is medium density, and c is wave propagating velocity through the medium [9]. In the fluid, the absorption of acoustic waves depends on the frequency, and it is expressed in the α_c/f^2 form, where frequency (f) in Hz. The acoustic wave absorption coefficient for water medium, nitrogen and oxygen gas at the room temperature, respectively 25×10^{-15} Np/m, 1.35×10^{-11} Np/m, and 1.61×10^{-11} Np/m [7]. And for the blood medium is about 0.18 dB/cm [10].

2.2 Transmission and Reflection Waves Intensity

In the propagation of a wave through boundary mediums, the wave will be reflected and transmitted as shown in Figure 1. Transmission and reflection in the boundary surface are depending on the medium acoustic impedance. If the discrepancy of acoustic impedance (Z) between the two mediums is large, it's indicated that most of the incidence wave energy will be reflected. In other hand, if the discrepancy is small, most of the incidence wave energy will be transmitted [11].

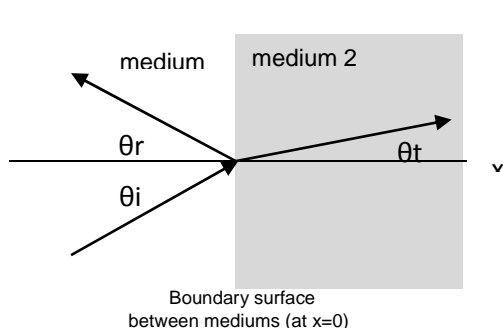

Figure 1 Schematic of reflection and transmission of the incidence waves on the boundary surface (modified from Kinsler, 2000).

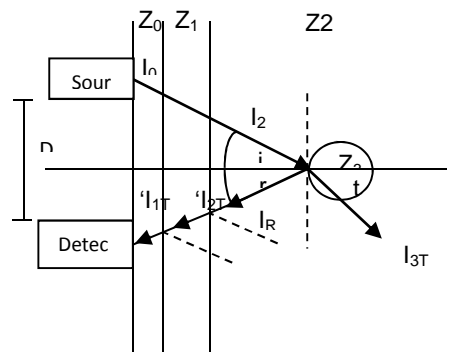

Figure 2 Schematic model of detection bubble with a reflection mode (modified from Rahiman et.al, 2013).

The intensity of the reflected (I_R) and transmitted (I_T) waves in the oblique incidence is determined by the following equation:

$$I_R = \left(\frac{Z_2 - Z_1}{Z_2 + Z_1} \right)^2 \quad (3)$$

and

$$I_T = \frac{4Z_1 Z_2}{(Z_2 + Z_1)^2} = 1 - I_R \quad (4)$$

where $Z_1 = \frac{\rho_1 v_1}{\cos \theta_1}$ and $Z_2 = \frac{\rho_2 v_2}{\cos \theta_2}$ are the acoustic impedances for two mediums, θ is the angle incidence wave to the normal line of the plane, ρ and v are respectively a medium density and the wave velocity through the medium [7]. The density and velocity of wave propagation in each medium are shown in Table 1.

Table 1 Density and velocity of the sound wave propagation [9]

Type of Medium	Density (kg/m ³)	v (m/s)
Glycerin	1.26x10 ³	1920
Acrylic	1.40x10 ³	2680
Water	1x10 ³	1498
Air	1.2	331
Blood [12]	1.06x10 ³	1570

2.3 The Effect of The Source-Detector Geometry Arrangement

Due to obstruct by the presence of another organ or tissues between the source and the detector it is difficult to set up the transmission measurement mode. Therefore, the reflection measurement was setup in order to detect the bubble as shown in Figure 2. In the reflection mode, the geometric arrangement of the source-detector will effect to the received wave intensity. Based on the analysis of the Figure 2, the value of angle θ or i can be determined by the following equation:

$$\theta = \sin^{-1} \left(\frac{r}{\sqrt{r^2 + l^2}} \right) \quad (5)$$

where r is a distance between the horizontal axis lines to the source, l is a distance between the surface wave to the detector surface, and D is a distance between the source and detector. The detection requirement of the minimum size of a detected bubble is determined based on the ratio of the bubble peripheral size to the source wavelength, as represented by the equation 6 [6].

$$\frac{2\pi a}{\lambda} \ll 1 \quad (6)$$

where a is bubble radius, k is a wave number. In order to the scattering of waves as well as reflections on the flat surface, the required value of ka is 2 [6].

3. Method

This study was conducted a computer simulation approach to analyze the signal attenuation, which caused by the presence of the bubble. The simulation was performed on water and blood medium which contained in the acrylic tube with 3 cm diameter and ultrasonic frequency source is about 40 kHz. The bubbles model was described in the

spherical and in it's filled with nitrogen and oxygen gas. Schematic model of detection bubble was shown in the Figure 2. The source-detector (D) distance variation was setup from 1 cm to 6 cm to obtain the percentage of the received intensity by the detector. The percentage of receiving intensity for water medium will be compared with to the blood medium.

4. Result and Discussion

The existence of the bubble in the medium acts as a barrier to the propagation, so that pressure exerted by the wave source causes vibrations of gas molecules in a bubble. The incident drives the scattering and absorption of incidence wave that will affect the intensity of the detected waves. Figure 3 shows the simulation result of the attenuation amplitude by water medium, and due to the presence of nitrogen and oxygen gas bubbles.

The attenuation discrepancy of acoustic wave due to absorption by the water medium, and absorption due to the presence of oxygen or nitrogen bubble is very small. The amplitude loss is about 0.0121%. Therefore, the attenuation due to wave absorption by the medium can be ignored. In addition, the presence of oxygen and nitrogen bubbles respectively, decreases the amplitude about 6.25% and 5.47%.

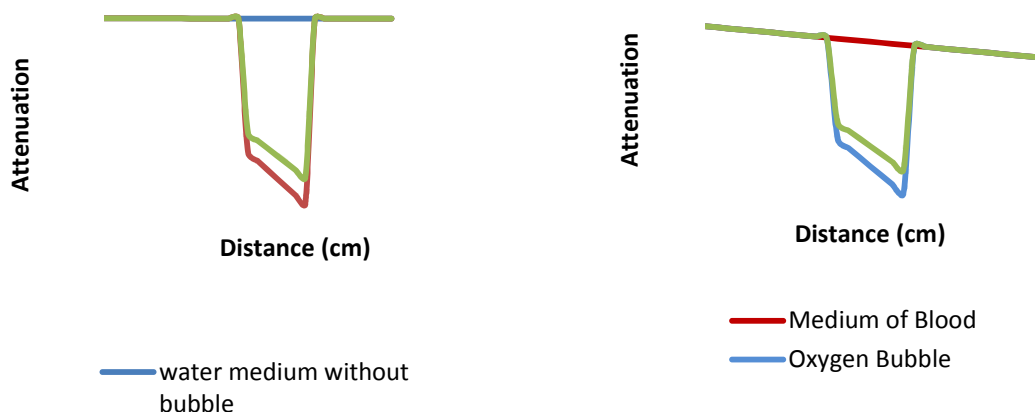

Figure 3 The simulation result of wave attenuation due to water medium absorption, and when there are nitrogen and oxygen bubbles.

Figure 4 The simulation result of acoustic wave attenuation due to blood medium absorption, and when there are nitrogen and oxygen bubbles.

Similarly, the absorption by the blood medium (Figure 4) without any bubble amplitude loss is about 1.1%. Meanwhile, the presence of oxygen and nitrogen bubbles in the medium, the attenuation respectively decreased 5.38% and 4.61%. The intensity value of the wave at each boundary medium is determinate using equation (3) and (4) at a distance (D) 1 cm as shown in Table 2.

Table 2. The intensity of the reflection and transmission waves at the boundary medium

Acoustic Impedance	Boundary Medium	Intensity	
		I _R	I _T
Z ₂ - Z ₃	Water-Bubble	0.999	0.001
Z ₂ - Z ₁	Water-Acrylic	0.202	0.798
Z ₁ - Z ₀	Acrylic-Glycerin	0.037	0.963
Z _{2'} - Z ₃	Blood-Bubble	0.999	0.001
Z _{2'} - Z ₁	Blood-Acrylic	0.165	0.835

The percentage value of receiving wave intensity detector for water and blood mediums at 1 cm distance was determined based on the wave intensity that led to the detector i.e. I_R , I_{2T} and I_{1T} .

(a) For water medium

$$\begin{aligned} \%I &= (I_R \times I_{2T} \times I_{1T}) \times 100\% \\ \%I &= (0.998992 \times 0.797862 \times 0.963174) \times 100\% \\ \%I &= 76.770\% \end{aligned}$$

(b) For blood medium

$$\begin{aligned} \%I &= (I_R \times I_{2T} \times I_{1T}) \times 100\% \\ \%I &= (0.999092 \times 0.834637 \times 0.963174) \times 100\% \\ \%I &= 80.317\% \end{aligned}$$

According to the intensity results, detector receiving more intensity of the ultrasonic waves that reflected by bubbles in the blood medium than in a water medium. Table 3 shows the percentage intensity ultrasonic waves which are received by the detector.

Table 3. Percentage of the received wave intensity of detector for water and blood medium with different source-detector distance

Source-Detector Distance, D (cm)	Intensity Percentage (%)	
	Water Medium	Blood Medium
1	76.770	80.317
2	73.810	77.626
3	68.909	72.920
4	62.881	66.924
5	56.588	60.524
6	50.582	54.323

The result shows an inverse correlation between distance and wave intensity that was detected by a detector. The received wave intensity will be decrease when the distance between source and detector increase as shown in the Figure 5. In Figure 5, it appears that the percentage of the reflection intensity for blood medium is greater than water medium. I can be explained that the acoustic impedance of blood is greater than the acoustic impedance of water. Similarly to the density and velocity of acoustic waves pass through the blood medium is greater than in the water medium.

Additionally, the simulation was conducted to determine the minimum diameter of the bubble that can be detected with a ka constant value 2 and using a various frequency of ultrasonic waves i.e. 40 kHz, 100 kHz, 200 kHz, 300 kHz, 500 kHz, and 1 MHz. The calculated results are shown in the graph of Figure 6. As shown in Figure 6, the capabilities of bubble detection depend on the frequency of the ultrasonic wave source. If the frequency of the ultrasonic waves used increasingly large, the minimum diameter of the bubble which can be detected will be smaller. It can be observed from the analysis results for the frequency resources using of 40 kHz, 100 kHz, 200 kHz, 300 kHz, 500 kHz, and 1 MHz respectively, are 23.84 mm, 9.53 mm, 4.77 mm, 3, 18 mm, 1.91 mm, and 0.95 mm. Hence, for the detecting bubble purposes, especially in the arteries is required ultrasonic frequency source with minimum frequency 1 MHz.

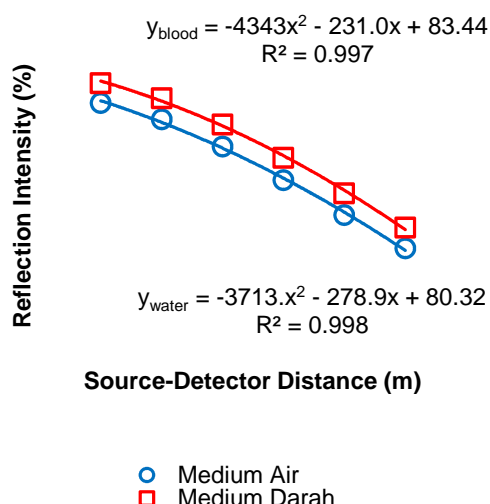

Figure 5 The percentage of the received wave intensity detector for water medium and blood medium.

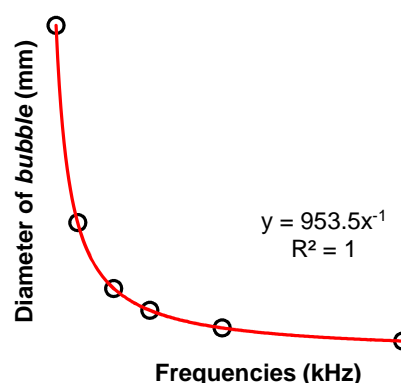

Figure 6 The minimum bubble size that can be detected using different frequencies.

5. Conclusion

The simulation results show that the attenuation of the ultrasonic signal intensity detected was influenced by several factors, including the medium characteristics, the presence and characteristics of gas bubble, and the distance of signal source-detector as a receiver. Attenuation due to medium absorption is very small, in which the amplitude loss for medium blood and water are respectively 1.1% and 0.012%. The existence of the bubbles in the medium can cause a loss of amplitude about 4% to 5%. Attenuation which caused by the presence of oxygen bubble is greater than the nitrogen bubble. In addition, the bubble detection capabilities depend on the source frequency usage. For the future work, a low-cost portable bubble detection instrument will be made for the application of early detection of decompression illness.

Acknowledgment

The author would like to thank to Department of Physics, Faculty of Mathematics and Natural Sciences, University of Mataram for supporting facilities in this research.

References

- [1] Chappell, M. (2006). *Modelling and Measurement of Bubbles in Decompression Sickness*. Ph.D Thesis, University of Oxford.
- [2] Dee, R. (2011). *Looking for Bubbles: Bubble Detection Methods for Predicting Decompression Illness in Divers Case Essay for CoMPEX CP1*.
- [3] Ahmed, Mawahib G.A, Adam, A.B, dan Dennis, J.O. (2009). Capacitive Air Bubble Detector Operated at Different Frequencies for Application in Hemodialysis. *International Journal of Electronical Computer, Energetic, Electronic and Communication Engineering*, Vol: 3, No: 2.
- [4] Fileti, A.M.F., Delator, F., and Pereira, J.A.F.R. (2007). *Optical Bubble Detection System for Chemical Industry Pipelines*. Chemical Engineering Transactions, Vol. 11.
- [5] Nishi, R.Y. (1993). "Doppler and Ultrasound Bubble Detection" dalam *The Physiology and Medicine of Diving* (P.B. Bennett and D. Elliott, Eds.), pp, 433-453. London: Sounders, ed 4.
- [6] Rahiman, M.H.F., Rahim, R.A., Rahim, H.A., Ayob, N.M.N., Mohamad, E.J., dan Zakaria, Z. (2013). *Modelling Ultrasonic Sensor for Gas Bubble Profiles Characterization of Chemical Column*. *Sensor and Actuators B: Chemical* 184.

- [7] Cheeke, J.D.N. (2002). *Fundamentals and Applications of Ultrasonic Waves*. Boca Roton: CRC Press.
- [8] Schmerr, L.W. and Song, J.S. (2007). *Ultrasonic Nondestructive Evaluation systems: Models and Measurements*. New York: Springer.
- [9] Kinsler, Lawrence. E., Frey, Austin. R., Coppens, Alan. B., dan Sanders, James. B. (2000). *Fundamental of Acoustics*. New York: John Wiley & Sons, Inc.
- [10] Wirza, E. (2008). Rekonstruksi Sinyal Akustik A-Mode menjadi B-Mode Sebagai Dasar Sistem Pencitraan Ultrasonik. Depok: Universitas Indonesia.
- [11] Rahiman, M.H.F., Zakaria, Z., Rahim, R.A. (2008). *Ultrasonic Process Tomographic Imaging Sensor: An Approach Utilising Transceivers Method*. International Conference on Computer and Communication Engineering (ICCCE 2008), pp. 1147-1150, 13-15 May 2008.
- [12] Mulyani (2012). Studi Penentuan Kecepatan Aliran Darah dan Frekuensi Terimaan Pasien Atherosclerosis Menggunakan Pesawat USG Clour Doppler. Makasar: Universitas Hasanuddin.

Development of Data Acquisition System of Moving Object for Landslide Monitoring System

Rahadi Wirawan^{1,*}, Bakti Abdillah², Wayan Sudiarta³, Dian Wijaya Kurniawidi⁴

¹ *Department of Physics, Faculty of Mathematics and Natural Sciences, University of Mataram, Indonesia*

* *Email: rwirawan@yahoo.co.id*

Abstract

This paper presents the design of data acquisition systems for the landslide monitoring system. These systems required for developing a mitigation system of the landslide disaster on the island of Lombok. Development of data acquisition system based on ATmega2560 microcontroller and ultrasonic sensor that used to detect the object displacement in the mechanic instrument system. The information about displacement data is used as landslide information. Embedding of a data logger system which integrated with the wireless communication is used to record the data and displayed on the web. The results of performance test system which developed shows that information data of the object shift can be recorded and displayed properly. The relative error maximum measurement is about 2%.

Keywords: *mitigation, landslide, data logger, wireless, microcontroller*

1. Introduction

Landslide disaster is the most destructive mass movement phenomena that occur as a result of the rocks collapse or the slopes movement. These phenomena can be detected earlier based on monitoring and analyzing the land movement that trigger the landslide. There are various sensors and methods are developed for monitoring purposes. Intrieri et al. (2012) combine an extensometer sensor with the rainfall sensor, a camera and thermometers for the development of early warning system (EWS)[1]. Lisnawati et al. (2013) develop an electric extensometer based on the changes in resistance value of potentiometer [2] and Zhu et al. (2011) develop an optic fiber transducer for landslide monitoring [3].

In order to obtain an accurate analysis and prediction from monitoring, we need data acquisition systems that have a high accuracy, precision. This system allows to the wireless monitoring especially facilitating the development an early warning system of landslide mitigation.

In this work, we design a low cost and robust data acquisition system for the land movement monitoring. To detect the land movement, ultrasonic sensor was proposed as a part of data acquisition instrumentation systems. The ultrasonic sensors was used in the measuring of 3D positions of an indoor mobile object [4], in determination of the vibration frequency of the object [5], measuring the wind speed and direction detection [6].

2. Materials and Methods

2.1. System Design

In the purposes for landslide monitoring, the design of a data acquisition consists of an ultrasonic sensor as a proximity sensor and the acquisition device. The acquisition device was built up using a data logger system and a wireless communication that embedded in the ATmega2560 microcontroller Arduino platform. This microcontroller is the main unit that collects data from the sensor and handles all the tasks of the system. To controlling and performing all the tasks of acquisition, the programming script was setup using the Arduino sketch and implanted into the

ATmega2560 chip. The block diagram of the data acquisition system is shown in the Figure.

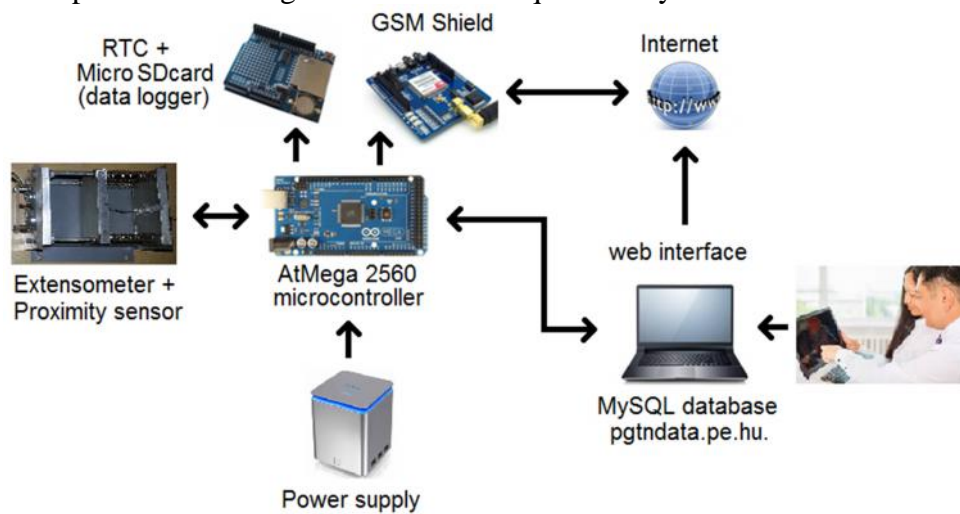

Figure 1 Block diagram of the data acquisition system

2.2. Output of System Design

For analyzing reasons, the resulting data acquisition will be saved in the MySQL database. In order to display the measured data, we built the connection between MYSQL database and the website using PHP programming with the flowchart as shown in the Figure 2.

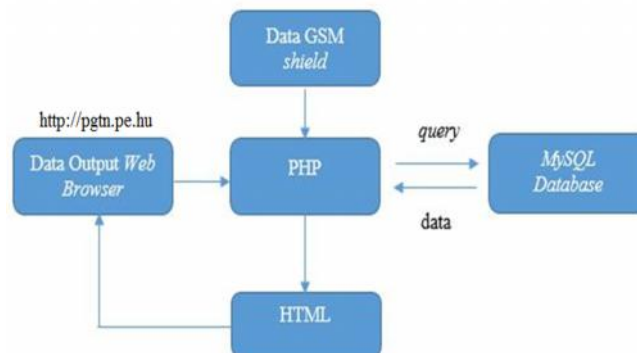

Figure 2 Flowchart of displaying data on the website

3. Results and Discussion

3.1 Implementation of the Acquisition Design

Figure 3 shows the physical system of data acquisition system in order to detect the object displacement in the mechanic instrument system of the landslide monitoring system. A system was controlled by the ATmega2560 microcontroller. The supply of power for the system comes from the external battery. For the indication of the land movement, we are using the PING Parallax ultrasonic as a proximity sensor to detect the object displacement (moving plate) in the mechanic instrument system (extensometer).



Figure 3. A prototype of data acquisition system.

The ATmega2560 microcontroller controlling of the measurement values from landslide sensor, the time of acquisition from RTC (Real Time Clock) and save onto the MicroSD card. The displayed data of the system include the measuring time and the distance of a moving object from the ultrasonic sensor.

3.2. Implementation of Output System Design

In the purposes of real time monitoring, a GSM shield SIM900 Quad-band is used for wireless communication. GSM supports outgoing and incoming data communication. This device was used to facilitate data transfer from the microcontroller input (sensor output) to the database. Furthermore, it will be displayed in the website of pgtndata.pe.hu. In Figure 4, we can see the recorded data from the simulation measurement that conducted. The data was displayed in the website.

Recording of the measured values and the time of acquisition is saved onto the MicroSD card as shown in the Figure 5. The stored data in the memory card with the file name that set is PGTNDATA.TXT and can be read in the TXT and CSV format.

ID	Waktu	X_Plait (Cm)
781	2016/11/29,17:23	6.760
780	2016/11/29,17:23	6.780
779	2016/11/29,17:22	6.760
778	2016/11/29,17:20	6.290
777	2016/11/29,17:20	6.210
776	2016/11/29,17:18	6.290
775	2016/11/29,17:17	6.120
774	2016/11/29,17:16	6.210
773	2016/11/29,17:15	6.210
772	2016/11/29,17:15	6.210
771	2016/11/29,17:14	6.210
770	2016/11/29,17:14	6.210
769	2016/11/29,17:13	6.120
768	2016/11/29,17:8	5.780
767	2016/11/29,16:58	5.980
766	2016/11/29,16:57	6.340
765	2016/11/29,16:55	6.470
764	2016/11/29,16:54	5.980
763	2016/11/29,16:53	5.980
762	2016/11/29,16:53	5.980

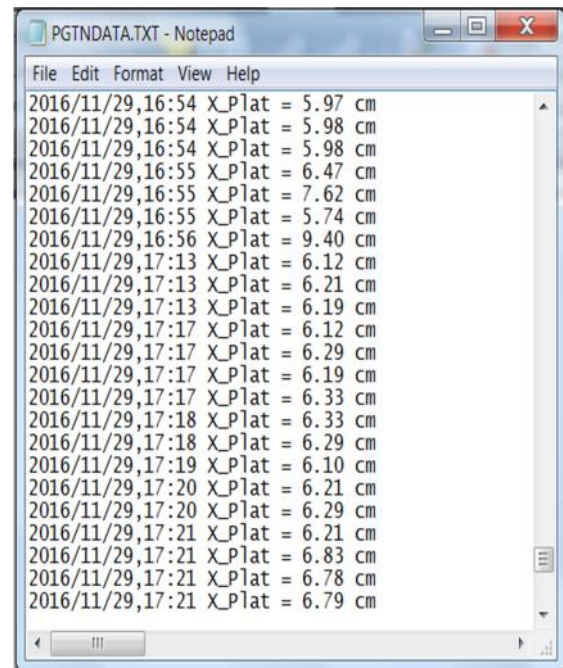

Figure 4 Displayed of sample data in the web database.

Figure 5 Recorded of sample data in data logger

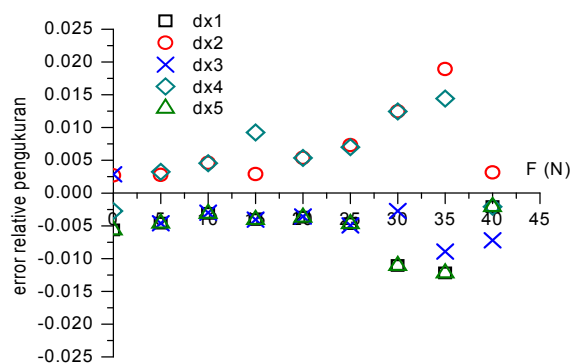

Figure 6. Relative error of measurement.

The measurement test result of the mechanical instrument of data acquisition system (extensometer), especially for the relative error of measurement was depicted in the Figure 6. From data analyzing result, we get the maximum error is about 2%. According the result, data acquisition systems have a good precision.

4. Conclusion

It has built a prototype of data acquisition system based on ATmega2560 microcontroller, data logger and a wireless communication SIM900 Quad-band GSM/GPRS. The results of a performance test which developed shows that information measured data of the moving object (land movement) can be recorded and displayed properly with the relative error maximum measurement is 2%.

Acknowledgements

This work was supported by Competitive Research Grant (Hibah Bersaing) 2016, Directorate General of Strengthening Research and Development, Minister of Research, Technology and Higher Education of Indonesia.

References

- [1] Intrieri E., Giovanni Gigli, Francesco Mugnai, Riccardo Fanti, Nicola Casagli, Design and implementation of a landslide early warning system, *Engineering Geology* 147–148, 124–136 (2012).
- [2] Lisnawati, Sri Wahyu Suciati dan Warsito, Rancang bangun Sensor Extensometer Elektris sebagai Pendeteksi Pergeseran Permukaan Tanah dan Sistem Akuisisi Data pada Komputer, *Jurnal Teori dan Aplikasi Fisika Vol. 01 No. 01*, 19-24 (2013).
- [3] Zhu ZW., Liu DY., Yuan QY., Liu B., Liu JC., A novel distributed optic fiber transducer for landslides monitoring, *Optics and Lasers in Engineering* 49, 1019–1024 (2011).
- [4] Kang, MH. and Lim, BG., Development of a practical foolproof system using ultrasonic local positioning, *Measurement* 79, 1–14 (2016).
- [5] Wirawan R., Mitra Djamal, Ambran Hartono, Edi Sanjaya, Widyaningrum Indrasari, dan Ramli Aplikasi Sensor Ultrasonik Untuk Pengukuran Getaran Frekuensi Rendah, *Prosiding Simposium Nasional Inovasi Pembelajaran dan Sains*, Bandung, 37-41(2012).
- [6] Xie K. and Wang K. (2011), Measurement of Wind Speed and Direction with Ultrasonic Sensor Using FPGA, *Energy Procedia* 12, 837-843(2011).

Preliminary Study and Synthesis Thin Film Of Fluorine Tin Oxide (Fto) With Sol-Gel Spin Coating Technique

Zahid Ramdhan¹, Aris Doyan^{1*}, Kosim¹, Susilawati¹, Syifa Azzahra¹, Norma Ikraman¹

¹*Master of Science education, Post Graduate Mataram University*

Lombok Indonesia¹

e-mail : ,^{b)}arisdoyan@yahoo.co.id

Abstract

Flourine doped tin oxide is one promising material as Transparent Conducting Oxide (TCO) to replace the expensive FTO in solar cell electroda, as gas sensor, optical coating, and variable resistor. In this research, Flourine doped tin oxide (FTO) thin films on glass substrate were prepared by the sol-gel spin coating. The starting material for synthesis FTO material is Tin (II) Chloride dehydrate ($\text{SnCl}_2 \cdot 2\text{H}_2\text{O}$), Hydroflouride (HF), and ethanol. As the material sol, Tin (II) Chloride dehydrate dissolved in ethanol, heated and stirrer using hot plate at 80 °C and 300 rpm for one hour. Then the solution using spin coating technique for one minute with 2000 rpm on glass substrate. The deposited films were baked at 150 °C for 10 minutes on oven at 100°C and annealed at 650 °C for one hour in a tube furnace.

Keywords: *FTO, sol-gel technique, substrate*

1. Intoduction

The development of thin layer technology is already widely used in everyday life of which are used in sensors, solar cells, batteries and touch screen, one of the ingredients to create a thin layer is a compound Tin Oxide (SnO_2).

A thin layer of SnO_2 is a type of n-type semiconductor, which has a chemical stability high, possess good transparency to light (the energy gap ~ 3.6 eV) (Carvalho et al, 2012), low electrical resistance, and has chemical stability high. Excellence a thin layer of SnO_2 widely applied in manufacturing industries in the transparent conductive electrode (TCO), solar cells, optical and electrical equipment gas sensor. Application TCO develops rapidly and has been applied to the devices of electronics such as LCD TVs, Plasma TVs, organic electroluminescence (EL), for example touch screen monitors on automatic tellermachine (ATM), ticket vending machines were installed in train stations, car navigation systems, handheld game consoles, mobile phones, and electrodes in solar cells (Sinaga, 2009).

SnO_2 attractive for development because the price is cheap compared to other semiconductors, nature responsive to a number of gases, has a long service life, and requires only a simple electronic device in the sensory implementation. To improve the performance of SnO_2 thin film material, research continues to be done to get the expected material characteristics. SnO_2 often produced in pure form or doped with other materials.

Based on the research that has been done, SnO_2 usually doped with indium or called ITO (Indium Tin Oxide) (Gurakar et al, 2013), ATO (Antimony Tin Oxide) (Hammad et al, 2011), FTO (Fluorine Tin Oxide) (Gurakar et al, 2013), and AFTO (Antimony and Fluorine-doped Tin Oxide) (Battal et al, 2014).

In this research used doping SnO_2 Fluorine is an element in the capture of 40% HF compound. Fluorine is the show all the forms of the elements (ionized, nonionizable) which means it is a chemical element that is very electronegative than other chemical elements.

The SnO_2 and doping concentration of HF use dilution with a ratio of 100%: 1%, 100%: 5%, and 100%: 10% to be placed on the glass substrates using Sol Gel Spin Coating

Various methods of growing a thin layer that has been used before, such as RF Sputtering (Yunanto et al, 2006), Chemical solution Deposition (Surono and Sutanto, 2014), Ultrasonic Spray Pyrolysis (Ajiet al, 2013), Cathodic Vacuum Arc Deposition (Wenget al, 2011), Physical Vapor Deposition (George et al, 2010), and sol-gel (Siregar, 2015). However, among these methods, sol-gel method is widely used, because of its low cost, its composition is homogeneous, does not use a vacuum chamber with a high level, the layer thickness can be controlled, and microstructures are quite good (Ahzan, 2012).

The Problem

- a. How comparative quality thin layer (thin film) of pure SnO₂ and SnO₂ are in doping Fluorine (SnO₂: F) using a glass substrate by using sol-gel spin coating?
- b. How do the characteristics of a thin layer (thin film) of pure SnO₂ and SnO₂ are in doping Fluorine (SnO₂: F) in terms of the crystal structure of the layer, the surface morphology of the structure of solids, as well as the optical characteristics?

The purpose

- a. To compare the quality of thin layers (thin film) and the pure SnO₂ (SnO₂: F) using a glass substrate by using sol-gel spin coating.
- b. To know the characteristics of a thin layer (thin film) and the pure SnO₂ (SnO₂: F) in terms of the crystal structure of the layer, the surface morphology of the structure of solids, as well as the optical characteristics

2. Materials and methods

Substrate used are glass measures 20 x 20 x 5 mm. Before use of the glass substrate, the glass is washed in stages. Washing gradually aims to remove dirt and oils that stick on the glass. Leaching the first stage, the glass substrate is inserted into a measuring cup containing a mixture of water and detergent, then vibrated using stirrer for 30 minutes. After that, the glass substrate is rinsed with water until clean. Washing the second stage, the substrate is put in a glass beaker containing ethanol, then vibrated with a stirrer for 30 minutes then wash with technical ethanol. The glass substrate is dried in a furnace at 100 °C for 1 hour. The glass substrate is clean, then stored in plastic clips.

The process of making sol-gel in this study using basic materials Tin (II) chloride dehydrate (SnCl₂.2H₂O with a molar mass of 225.63 g/mol, purity 99.9%), ethanol and HF each of which serves as the solute, solvent and stabilizer (stabilizer). In this study, sol-gel materials are synthesized is divided into three (3) with a concentration ratio of 100%: 1%, 100%: 5%, and 100%: 10%. Then mix in a measuring cup on a stirrer at a temperature of ± 80 °C for 1 hour, or until the solution looks homogeneous mixture.

The process begins with a layer of growth in sol-gel material drops on the substrate 0.1 ml to 5 times a trickle. Then centrifuged for 1 minute with a rotation speed of 2000 rpm. Once the surface evenly coated substrate, the substrate is dried in a furnace at 100 °C for 10 minutes.

The heating process is done in three stages. First heating at a temperature of 150 °C for 1 hour, aiming to remove water and residual solvent levels in the coating gradually. A second heating at a temperature of 350 °C for 1 hour. The increase in the regulated temperature slowly from room temperature to 350 °C. This stage is regarded as the pre-heating function to remove ethanol, water, and facilitating change SnCl₂.2H₂O to SnO₂. The next stage is the post-heating or heating end at 550 °C, for 1 hour. Similar to the process of pre-heating, regulated temperature rise slowly from room temperature to 550 °C. Post-heating is used to form the SnO₂ particles with a uniform crystal orientation, and eliminating pores.

3. Result and Discussion

The materials used in the synthesis of SnO₂ crystal research with a thin layer of sol-gel method is:

1. Tin (II) chloride dehydrate (SnCl₂·2H₂O with a molar mass of 225.63 g/mol, purity 99.9%), a total of 2.2653 gram.
2. Ethanol C₂H₅OH, 20 ml.
3. Hydrofluoric Acid (HF) 40%, a total 0.125 ml, 1,25 ml, and 12,5 ml.

Synthesis of SnO₂ crystals with a thin layer of sol-gel method following the sol-gel chemistry equation as follows:

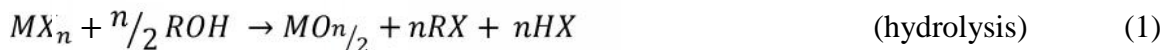

Sol-gel solution for a wide range of concentrations that have been synthesized are stored in a test tube as figure 1.



Figure 1. Results of Sol-Gel-Varying concentrations from left to right with a concentration 100%, 100%: 1%, 100%: 5%, and 100%: 10%

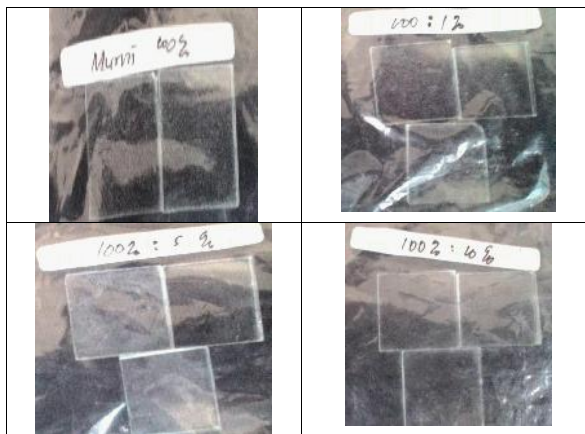

Figure 2. Results of Thin Film Crystalline SnO₂ and SnO₂ : F for the heating

One thing to be determined is proving SnO₂ structure which has a tetragonal structure with a rutile-type crystal with unit cell parameters a = b and c, as figure 3.

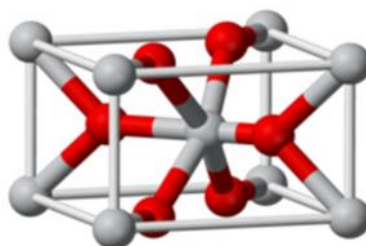

Figure 3. The model of the unit cell of the crystal rutile SnO₂

4. Conclusion

This research is preliminary to the formation of the sample. The basic ingredients used are Tin (II) chloride dehydrate ($\text{SnCl}_2 \cdot 2\text{H}_2\text{O}$ with a molar mass of 225.63 g/mol, purity 99.9%), a total of 2.2653 gram, $\text{C}_2\text{H}_5\text{OH}$ Ethanol 20 ml, and Hydrofluoric Acid (HF) 40% as much as 0.125 ml, 1.25 ml, and 12.5 ml. Sol-gel materials are synthesized is divided into three (3) with a concentration ratio of 100%: 1% (2.2653 gram: 0,125: 20 ml), 100%: 5% (2.2653 gram: 1.25: 20 ml) and 100%: 10% (2.2653 gram: 12.5: 20 ml). after the sol-gel material so the sample will grow on glass substrates by using sol-gel spin-coating.

Acknowledgements

Thank you very much to Master Programe Science Education Mataram University and Analytic Laboratorium Mataram University Indonesia.

References

- [1] Carvalho et al. 2012. Synthesis and characterization of SnO_2 thin films prepared by dip-coating method, 15th Brazilian Workshop on Semiconductor Physics. Elsevier P hysics Procedia, 28 : 22-27.
- [2] P. Sinaga. 2009. *Pengaruh Temperatur Annealing terhadap Struktur Mikro, Sifat Listrik dan Sifat Optik dari Film Tipis Oksida Konduktif Transparan $\text{ZnO}:\text{Al}$ yang Dibuat dengan Teknik Screen Printing*, *Jurnal Pengajaran MIPA*, 14(2):51 – 59
- [3] Gurakar, et al. 2014. Electrical and microstructural properties of (Cu, Al, In)-doped SnO_2 films deposited by spray pyrolysis, *ADVANCED MATERIALS Letters*, 5(6) : 309-314.
- [4] T. M, Hammad, and N.K, Hejazy. 2011. Structural, Electrical and Optical Properties of ATO Thin Films Fabricated by Dip Coating Method, *Int. Nano Lett.*, 1(2): 123 – 128.
- [5] Battal, et al. 2014. *Comparison Effect of Spin Speeds and Substrate Laters on Properties of Doubly Doped Tin Oxide Thin Films Prepared by Sol-Gel Spin Coating Method*, *Journal of Ovonic Research*, 10 (2) :23
- [6] Yunanto, dkk.. 2006. “*Deposisi Lapisan Tipis ZnO sebagai Lapisan Tipis Tipe N dan Jendela Sel Surya CuInSe_2* ”. *Indonesian Material Science Journal*. ISSN 1411-1098 Vol.8, hal 183 – 187.
- [7] A. N, Surono and H, Sutanto. 2014. “*Sifat Optik Zinc Oxide (ZnO) yang Dideposisi di Atas Substrat Kaca Menggunakan Metode Chemical Solution Deposition (CSD) dan Aplikasinya untuk Degradasi Zat Warna Methylene Blue*”. *Youngster Physics Journal*. ISSN: 2303-7371, Vol 2, No. 1, hal. 7-14.
- [8] W. P, Aji. dkk.. 2013. “*Pengaruh Suhu Tumbuh Terhadap Struktur Kristal Lapisan Tipis ZnO 0.02 mol*”. Seminar Nasional Fisika, Universitas Negeri Jakarta.
- [9] M. H, Weng, et al.. 2011. “*Structure, Optical and Electrical Properties of ZnO Thin Films on The Flexible Substrate by Cathodic Vacuum Arc Technology with Different Arc Currents*”. *Elsevier Ceramics International*, Vol 05, hal. 043.
- [10] P, George, et al.. *Microstructure and Field Emission Characteristics of ZnO Nanoneedles Grown by Physical Vapor Deposition*”. *Elsevier Materials Chemistry and Physics*, Vol 123, hal. 634-638.
- [11] N. Siregar, et al.. 2015. “*The Effect of Concentration of Structure and Optical Properties of Thin Films Synthesized by Sol-Gel Methods Spin Coating*”. *International Journal of Sciences, Basic and Applied Research (IJSBAR)* ISSN 2307-4531, Vol 22, hal. 428-434.
- [12] S. Ahzan., dkk.. 2012. “*Sintesis Lapisan ZnO dengan Metode Sol-gel Spincoating dan Karakteristik Sifat Optiknya*”. Tidak Diterbitkan. Tesis. Surabaya: Fisika MIPA Institut Teknologi Sepuluh November.

The Livelihood Strategy of Dry Land Farmers in Karang Bayan Village, West Lombok, Indonesia

I Ketut Budastra¹, Taslim Syah¹, IGL. Parta Tanaya¹, Suparmin¹, Halil^{1*}

¹Mataram University, Lombok, Indonesia

* Email:iketutbudastra@yahoo.com

Abstract

The provision of wealthy livelihood opportunities is important and strategic for households and equitable development in every country, including in Indonesia. This needs effective and efficient programs, particularly for those living at the bottom of the socio-economic pyramid, such as dry land farmers. This paper aims to analyze the livelihood strategies of the dry land farmer households in relation to the livelihood asset portfolio capacities of the households. The analyses are mainly based on primary data collected through in-depth interviews of 30 randomly selected households during Oct-Nov 2016; and secondary data collected from local government institutions. The analysis found that the majority of the households attempt to maximize the utilization of their labor force, farm land and skills to increase incomes; apply thrifty spending strategy to reduce expenditures; and employ income-expenditure balancing strategies to reduce vulnerabilities. Suitable capacity building programs are essential for the households to sustainably improve their livelihoods. Awareness of the households urgently needs to be enhanced regarding the potential benefits of the on-going social protection programs for reducing their incomes and vulnerabilities. In addition, further investigations to evaluate the effectiveness of the ongoing social protection programs; and the causes and the solutions are warranted.

Keywords: *livelihood strategy, assets, dry land farmer, Indonesia*

1. Introduction

Poverty alleviation has become a major focus of socio-economic development programs and activities in every country worldwide, including Indonesia, since the introduction of the millennium development goals (MDGs). As a result, the proportion of population living in poverty declined substantially. In Indonesia, for example, the proportion of population living in poverty declined about 6 percent during 2006-2013 (TNP2K, 2014). The poverty level was greatly different among regions, higher levels were found in eastern regions such as in Nusa Tenggara Barat province (21.55% in 2010).

The situation indicates the need of systematical search for improved poverty alleviation programs and activities in Indonesia by addressing weaknesses of the ongoing programs. For this intention, one of the strategic issues which become the focus attention of this paper is concerning the mismatch between the interventions given and the need of the target households, as indicated in the Media. The mismatch is potentially reduced by better understanding the livelihood context of the target population, the poor.

The objectives of this paper are to analyze (i) their livelihood asset portfolio capacity; and (ii) their livelihood strategies. This paper applied sustainable livelihood approach as the framework (Chambers & Conway, 1991, p. 6); took the dry land farmer communities in Karang Bayan Village of West Lombok District (as a case study); and in-depth interviewed 30 (randomly selected) household respondents, during Oct.-Nov. 2016.

The paper is organized into four Sections. Section one introduces the backgrounds, objectives

and research methodology. Section two discusses the households' livelihood asset portfolio capacities. Section three analyses the households' livelihood strategies. Section four concludes the findings and provides several suggestions.

2. The Households' Livelihood Asset Portfolio Capacity

The households' livelihood Assets is differentiated into five, namely; human, physical, financial, social and political capitals. For simplicity reason, this paper measured the capitals in 5 scale indices: 1 smallest - 5 largest (Table 1). It shows that the majority of the households scored low to very low in human physical, financial and political capital; but scored high in social capital.

Table 1 Frequency distribution of respondents by livelihood asset portfolio capacity indexes

Indexes	Human	Physical	Financial	Social	Political
1	14	12	23	1	18
2	1	11	4	6	0
3	7	5	0	0	4
4	1	1	0	5	1
5	7	1	3	18	7

3. The Households' Livelihood Strategies

On income side, the households take 8 different strategies, each of them includes: increasing income through improving farm productivity (Table 2). This is as expected since the households are dry land farmers. In addition, the majority of the households also include one or more initiatives to increase their incomes, such as: processing, trade, animal grower, technical worker and farm laborer. While most of the households take one additional income generating initiative, some take two.

Table 2: Frequency distribution of the respondents by their increasing income strategies

No	Strategy	Freq.	%
1	Farm productivity improvement (FPI)	7	23
2	FPI & processing	6	20
3	FPI & trade	6	20
4	FPI & animal grower	4	13
5	FPI & technical worker	3	10
6	FPI & farm laborer	2	7
7	FPI, processing & technical worker	1	5
8	FPI, processing & trade	1	5
Total		30	100

On the expenditure side, there are 5 different strategies taken by the households to reduce expenditure, each has thrift spending component (Table 3). Other initiatives included in their strategies are: self-producing foods, self-producing farm inputs, reducing input use, or reducing paid labor.

Table 4: The household strategy to reduce expenditure

No	Strategy	Freq.	%
1	Thrift	14	47
2	Thrift & self-producing food materials	6	20
3	Thrift, self-producing farm inputs	5	17
4	Thrift & reducing input use	3	10
5	Thrift & reducing the use of paid laborers	2	7
Total		30	100

In regard to vulnerability reduction, the households take 8 different strategies, each contains a ‘balancing expenditure with income’ (BEI) component (Table 4). While 47% of the households take BEI as a sole strategy, the rest combine BEI and another component, namely: farm diversification, additional income, farm land enlargement, credit access, selling produce before harvest, savings, and group participation.

It is important to note that none of the households actually includes the benefits of the ongoing vast social protection programs into their vulnerability reduction strategies. This may indicate there is a problem with the effectiveness of the ongoing social programs, and hence a further investigation is warranted to identify the causes and solutions.

Table 4 The household strategy to reduce vulnerability

No	Strategy	Freq.	%
1	Balancing expenditure with income (BEI)	14	26
2	BEI & farm diversification	14	26
3	BEI & additional income	12	23
5	BEI & farm land enlargement	5	9
4	BEI & credit access	4	8
6	BEI & selling produce before harvest season	2	4
7	BEI & savings	1	2
8	BEI & group participation	1	2
Total		30	100

4. Conclusions

The livelihood strategies of the farmer households are largely determined by their own asset portfolio capacities, and living environment. The majority of the households attempt to maximize the utilization of their livelihood assets to increase incomes; take thrift-spending as their reducing expenditure strategies; and apply income-expenditure balancing as their reducing vulnerability strategies.

An effective empowerment program is necessary for the households to sustainably build their capacities, particularly, in terms of technical and business skills and financial assets. Awareness of the households regarding the potential benefits of the on-going social protection programs for reducing their incomes and vulnerabilities needs to be enhanced. Further investigations to evaluate the effectiveness of the ongoing social protection programs are also

warranted.

References

- [1] Asian Development Bank, *Basics Statistics 2014*. Manila, Bangkok: Economics and Research Department: Development Indicators and Policy Research Division, 2014.
- [2] R. Chambers & G. Conway, *Sustainable Rural Livelihoods: Practical Concepts for the 21st Century*, Institute for Development Studies, DP 129. Brighton: University of Sussex, 1999.
- [3] TNP2K, *Why Poverty Still Matters in Indonesia*. (Retrieved from tnp2k.go.id: July 2014).

Nonparametric Regression Spline in The Estimation of The Average Number of Children Born Alive Per Woman

Nurul Fitriyani^{1*}, I Nyoman Budiantara², Ismaini Zain², Vita Ratnasari²

¹*Department of Mathematics, University of Mataram*

Jalan Majapahit No. 62 Mataram 83125, Indonesia

²*Department of Statistics, Sepuluh Nopember Institute of Technology*

Sukolilo, Surabaya 60111, Indonesia

**Email: nurul.fitriyani@unram.ac.id*

Abstract

Fertility is one of the main elements underlying the population growth in a country. One measure used to determine the fertility rate is the average number of children born alive per woman. In general, the patterns of female fertility change at specific ages. In this study, the fertility pattern of women was investigated by using nonparametric regression spline approach. Spline approach is strongly influenced by the presence of knot points. There are several methods that can be used to select the optimal knots in the spline approach, such as the method of cross validation and generalized cross validation. This study showed that there was a shift in the location of the knots, which mean that there was a shift in the pattern of the average number of children born alive per woman in East Java over a period of 3 years, from 2010 to 2012.

Keywords: *Fertility, Nonparametric Regression, Spline.*

1. Introduction

One of the main problems faced by developing countries such as Indonesia relates to population, because it is one factor that related to national development. Population growth in a country is essentially based on three main elements; fertility, mortality, and migration [1]. Several measures can be used to determine the birth rate in a region. One of which is the average number of children born alive per woman. It can describe the level of fertility in a region, because it is used to determine the number of births in each age group until the end of a woman's reproductive period [2]. Age is one of the factors affecting the fertility in woman [3]. The pattern and character of the women fertility change at certain ages. They greatly according to a statistical approach, namely nonparametric regression spline.

Nonparametric regression has a high flexibility in estimating the regression curve. Regression curve used to explain the relationship between two variables [4]. Nonparametric regression approach does not assume the shape of the regression curve [5]. In nonparametric regression, there are several approaches to estimate the model of regression curve, as mentioned in [6], the Kernel approach, Histogram, Orthogonal series, Fourier series, Wavelets, and Spline. Especially for spline, it can model the data which has particular sub-intervals of data pattern. It is one type of polynomials, which has segmented characteristics. The segmented characteristics provide more flexibility than the usual polynomial, making it possible to more effectively adapt to the local characteristics of a function or data [7].

Spline function of degree m is any function that can be presented in the following equation:

$$g(x_i) = \sum_{j=0}^m S_j x_i^j + \sum_{j=1}^J S_{j+m} (x_i - k_j)_+^m \quad (1)$$

with S_j states the real constants, and $(x_i - k_j)_+^m = (x_i - k_j)^m, x \geq k_j; 0, x < k_j$. The values of $m = 1, 2,$ and 3 respectively obtained linear spline, quadratic spline, and cubic spline and k_j are the knot points [8]. Spline function is very depend on the knot values. Knot is the point where there is a mix with a pattern of behavior changes on different intervals [9].

In this study, the average number of children born alive per woman was estimated. Researchers used the average number of children born alive per woman to determine the woman fertility pattern in East Java over a period of 3 years from 2010 to 2012.

2. Materials and Methods

This study used secondary data. The fertility data over a period of 3 years from 2010 to 2012 obtained from the National Socio–Economic Survey from Central Bureau of Statistics of East Java. This study used two variables, i.e. the dependent variable (the average number of children born alive per woman) and the independent variable (the reproductive age of women in certain age groups of 15 – 49 years old).

The statistical analysis for the fertility data, were as follows: (1) scatter plot between two variables was created for each year; (2) the values of GCV were calculated for each spline regression model and the optimal knot points and optimal order were obtained based on the minimum value of GCV; (3) the significance of the parameter from (2) was tested and the residual diagnostic generated by nonparametric regression spline models with minimum GCV; (4) the value of estimated R^2 and MSE of nonparametric regression spline models was compared; and (5) the results were used to determine the development and female fertility pattern shifts at different age levels in East Java over a period of 3 years from 2010 to 2012.

3. Results and Discussion

Figure 1 shows the scatter plot of the data over a period of 3 years, from 2010 to 2012.

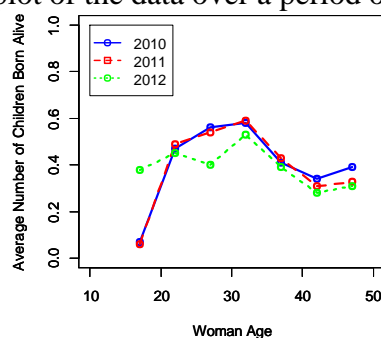

Figure 1 Scatter Plot Between Two Variables

The results indicated a change of pattern in a particular sub-interval. In 2012, the average number of children born alive per woman increased in the beginning of the childbearing age compared with the previous years. The average number of children born alive per woman in 2012 increased slowly in the age interval of 15–24 years old then fell at the age interval of 25–29 years old. It increased again in the age interval of 30–34 years old and finally dropped at the end of the productive period. The changing patterns of fertility in certain age groups (interval) caused the data would be less precise when approximated using parametric

regression. Therefore, a nonparametric regression spline approach was used.

The optimal knot point was obtained from the minimum value of GCV. Table 1 given a summary results of the minimum value GCV for each year by using 1, 2, 3, and 4 knots.

Table 1 Optimal Knot Point using GCV Method for Fertility Data

Knot Points		Year		
		2010	2011	2012
1 Knot	K ₁	23.73	23.73	31.69
	GCV (R ²)	0.0054602 (92.9)	0.0055405 (93.4)	0.0051679 (71.8)
2 Knots	K ₁ ; K ₂	24.35; 43.33	17.61; 30.47	33.53; 40.27
	GCV (R ²)	0.0049085 (96.4)	0.0066904 (95.5)	0.0042034 (87.1)
3 Knots	K ₁ ; K ₂ ; K ₃	22.51; 31.08; 39.65	17.61; 34.14; 39.04	29.24; 35.37; 37.82
	GCV (R ²)	0.0000186 (99.9)	0.0000001 (99.9)	0.0042001 (94.3)
4 Knots	K ₁ ; K ₂ ; K ₃ ; K ₄	23.32; 29.63; 35.95; 37.53	21.74; 35.95; 39.11; 42.26	20.16; 28.05; 35.95; 37.53
	GCV (R ²)	0.0000101 (99.9)	0.0000000 (100)	0.0000102 (99.9)

From the results, by seeing the values of the coefficient of determination R² and the values of MSE (mean squares error) also the residual assumptions testing, found that the optimal knot that provided a reliable spline given by using four knots. In modeling the fertility data using spline, with the selection of the optimal knot points using GCV, researchers found that the values of R² were relatively high with low values of MSE. The values of R², MSE, and the residual assumptions testing (independent and identically distributed, i.i.d) indicated that the GCV method was more feasible to use in subsequent analysis for the case study.

The results showed a shift in the location of the knots. Knots were the location where the change in women fertility patterns, both changes that showed increased or decreased number of female fertility. For example, the location of the first knot point (K₁) was 23.32 years old in 2010, shifted to 21.74 years old in 2011, and finally changed to 20.16 years old in 2012. Shifting the location of this knot points (K₁, K₂, K₃, and K₄) kept happening every year, either into a higher and lower age.

Estimation models for each year were produced from the optimal knots using GCV method in Table 1 were as follows.

$$\hat{y}_{2010} = -1.2912 + 0.0801x_j - 0.0844(x_j - 23.32)_+ + 0.0181(x_j - 29.63)_+ - 0.2277(x_j - 35.95)_+ + 0.2238(x_j - 37.53)_+ \quad (2)$$

$$\hat{y}_{2011} = -1.4738 + 0.0902x_j - 0.0802(x_j - 21.74)_+ - 0.1995(x_j - 35.95)_+ + 0.2859(x_j - 39.11)_+ - 0.0975(x_j - 42.26)_+ \quad (3)$$

$$\hat{y}_{2012} = -0.0952 + 0.0279x_j - 0.0379(x_j - 20.16)_+ + 0.0454(x_j - 28.05)_+ - 0.3002(x_j - 35.95)_+ + 0.2710(x_j - 37.53)_+ \quad (4)$$

Spline estimation curves from year 2010, 2011, and 2012 with 4 optimal knot points selected by GCV are given in Figure 2. It showed the shifting patterns of fertility data over a period of 3 years from 2010 to 2012.

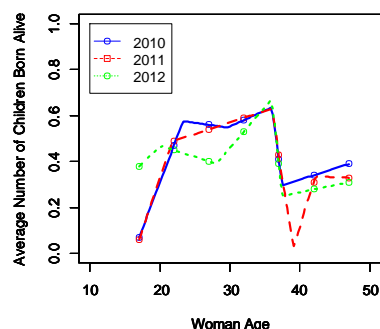

Figure 2 Spline Estimation Curves for Woman Fertility Data

From Figure 2, the average number of children born alive per woman in 2012 for the first age group (woman with 15–19 years old) had a higher value than the previous years. This might be occurred due to the reduction in infant mortality in 2012, thus increasing the average number of children born alive per woman. Among women age interval of 20–34 years old, the average number of children born alive per woman in 2012 tended to be at a lower value when compared to the previous years. This was also happened at the end of women childbearing age, i.e. women age interval of 45–49 years old. This might occur due to the success of family planning programs implemented by the government, so it could decrease the average number of children born alive per woman in East Java in 2012.

Based on the study, changes in woman fertility pattern over a period of 3 years from 2010 to 2012 could be seen through the location of the optimal knot points obtained. This results suggested the changes in woman fertility patterns were not exactly at the midpoint of the interval of the age groups, i.e. at the age of 17, 22, 27, 32, 37, 42, and 47 years old, but shifted according to the location of the knot points obtained.

4. Conclusion

There was a shift in the woman fertility pattern in East Java Province from 2010 to 2012. The location of change in woman fertility patterns was not exactly at the midpoint of the interval age group, but at the optimal knot points. For future study, woman fertility pattern might be solved using quadratic and cubic spline approach to get a better result.

References

- [1] Lulan, A.C., Fertility Modeling in East Nusa Tenggara Province with Logistic Regression Approach and Radial Basis Function Neural Network (RBFNN), *Magister Thesis*, Surabaya, ITS, 2011.
- [2] Central Bureau of Statistics, National Socio-Economic Survey in 2011, *The Central Bureau of Statistics Catalog of East Java Province*: 3101001.35, 2011.
- [3] Budiantara, I.N., The Estimation of Female Fertility Model in Indonesia by Using Spline Regression, *Final Report of the Implementation of the Women's Studies Research Year 2007*, Surabaya, ITS, 2007.
- [4] Budiantara, I.N., Polynomial Truncated Spline Models Family in Semi Parametric Regression, *Periodic of Mathematics and Natural Sciences Faculty*, Surabaya, ITS, 2005.
- [5] Eubank, R.L., *Spline Smoothing and Nonparametric Regression 2nd Ed.*, New York, Marcel Decker, 1999.
- [6] Budiantara, I.N., Weighted Spline Estimator Consistency Based on Integrated Mean Square Error Criteria, *Proceedings of the Mathematics National Conference, Indonesian Mathematical Association XII*, Bali, Mathematics Department Udayana University: 979-99592-0-9, 2004.
- [7] Budiantara, I.N., Spline Model with Optimal Knots, *Journal of Basic Science*, State University of Jember, 7, pp. 77-85, 2006.
- [8] Hardle, W., *Applied Nonparametric Regression*, New York, Cambridge University Press, 1990.
- [9] Wahba, G., *Spline Models for Observational Data*, SIAM, *CBMS-NSF Regional Conference Series and Applied Mathematics*, Philadelphia, 1990.

Development Elements of Industrial Production Increase in Productivity Of Micro / Small (Export Oriented Product) for Enhancing Competitiveness of Industry [Case Study: In Lombok-NTB]

I G.A.K Chatur Adhi Wirya Aryadi *, I Made Wijana, I Wayan Joniarta

*Department of Mechanical Engineering, Faculty of Engineering, University of Mataram
Jln. Majapahit No. 62, Mataram, NTB, Post Code 83122, Tel (0370) 6363126*

** Email: empatadhi@yahoo.com*

Abstract

With the obtained value-indigo productivity on each SME, we can define improvement the SMEs targets. By using reference values as a basis for selecting the smallest productivity of SMEs, we can determine what we will improve.

SMEs Dimas Silver and Songket Tradisi is a target implementation of a productivity applied, because it has a partial and total productivity smallest. Alternative work is an addition of a design and the use of E-Comer for both SMEs.

Of the application of alternative sales increased 15% for silver and 10% Dimas to Songket Tradisi. The impact of the increase in sales over the increased productivity of both productivity. Dimas silver have material productivity on first year of 2.86 and 3.28 for the second year. And total productivity Songket 0.76 for the first year and 0.9 for the second year

Keywords: *productivity, alternative, small and medium enterprises, e-comerse*

1.Introduction

Micro, Small and Medium Enterprises (SMEs) have an important role in the national economic resilience when the critical condition of the economic is occurring. Over the years, SMEs face severe challenges and opportunities with the opening of the ASEAN-China Free Trade Agreement (ACFTA). Therefore, the Strategic Plan of the Ministry of Cooperatives and Small and Medium Enterprises for 2010-2014 prepared for the empowerment of SMEs, as well as addressed the lack of accurate information about the condition of SMEs. So it takes the involvement of various stakeholders (local government, the Ministry, the Department of Cooperatives, Universities, and Actors SME)

2. Productivity Concept

2.1.Productivity, Efficiency and Effectiveness

Experts do not provide the same productivity formula, for that it is still found the notion of productivity in many ways, but, in principle, they have in common as

$$Productivity = \frac{Input}{output} \text{ and so } Productivity = \frac{Effectiveness}{Efficiency} \quad (1)$$

According to the National Productivity Council (1983), productivity is the ratio between the results achieved with the overall resources used. Moreover, the high productivity is achieving the highest level of outputs (effectiveness) with a declining resource use (efficiency)

2.2 Productivity measurement

The simplest productivity measurement model is the ratio approach of output / input (Gaspersz, 1998). Productivity measurement based on the ratio approach of output / input will be able to produce three types of productivity measurements, namely: (1) partial productivity, (2) total-factor productivity, and (3) the total productivity.

2.3 Increased Productivity

Productivity is the ratio of output to input, so that the company's strategy to increase the productivity of the system can be done through the following five ways to be adapted to the situation dam condition of the company, among others: (1) Applying the cost reduction program, (2) Managing growth, (3) Working more agile. (4) Working more effective, (5) Reducing activities (Gaspersz, 1998).

3. Experimental Set Up

3.1 Conceptual Framework

The method used is the method of description (descriptive) and approach the ratio of output / input for the measurement of productivity. Plans and steps of productivity, which are then evaluated whether the plans and the steps effectively increase the productivity of SMEs, are expected to increase in the ratio of the total and partial productivity.

An outcome to be achieved in the second year of study (2) is a priority industry clusters based on productivity, the blueprint for the empowerment of industrial policy map.

4. Results And Discussion

Figure 1 shows the position of Dimas silver SME having the lowest material partial productivity.

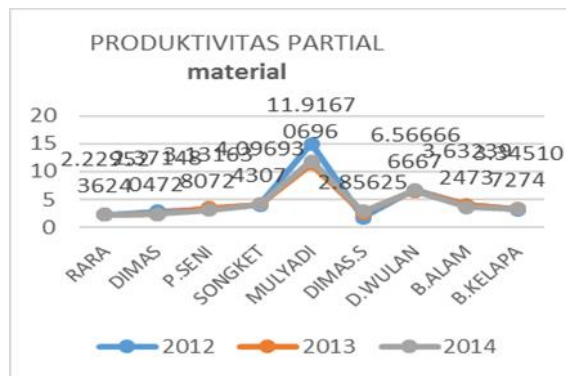

Figure 1. Partial productivity (The smallest Dimas Silver)

After revamping by adding design and good marketing the data show an increase in the next year

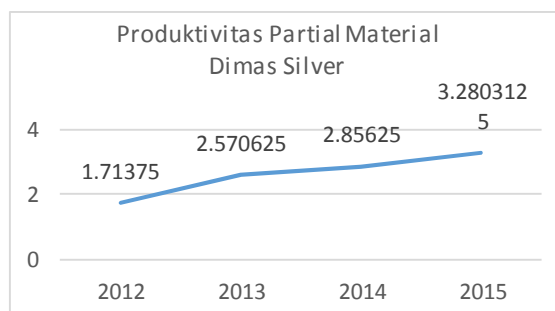

Figure 2. The increased partial productivity (for the smallest Dimas Silver)

To level the total productivity of SMEs songket tradition has the lowest productivity, as shown in the graph below. The total productivity level of the SMEs traditionsl songket has the lowest productivity, as shown in figure 3.

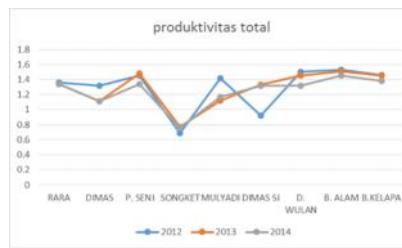

Figure 3. Total productivity of all SMEs

The increment of total productivity are achieved after some improvements, e.g. design, coloring, and ergonomically production process are performed, see figure 4.

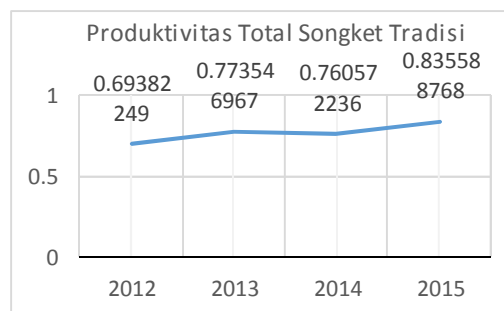

Figure 4. Improvements of the total productivity of traditional Songket

4.1. Results Implementation

Implementation of alternatives that have been designed in the form of adding design and implementation of e-comers, SME sales data are obtained for the last 3 months. Dimas Silver SME has an increased sales by 15% and in the first year, the partial material productivity is 2.86 while in the second year it onwards 3.28. SMEs Traditional Songket has increased sales by 10%, and the increased total productivity of 0.76 in the first year to 0.84 in the second year.

4. Conclusion

1. SMEs that are becoming a target, is Dimas Silver and Traditional Songket Gallery
2. Alternative developments that can be chosen are design development and E- comers.
3. The alternative development that have been presented can give productivity enhancements.

Acknowledgement

The authors would like to acknowledge the Ditlitabmas Kemeristekdikti for the funding.

References

- [1]. Anonim, 2012, "Payung Penelitian Unggulan Universitas Mataram", Unram, Mataram.
- [2]. Anonim, 2013, "Keputusan Rektor Unram tentang pembentukan kelompok-kelompok peneliti bidang ilmu di Universitas Mataram", Unram, Mataram.
- [3]. Arman N, 2000, "Perencanaan dan Pengendalian Produksi", Guna Widya, Jakarta..
- [4]. BPS, 2012, "Data Spasial Penanggulangan Kemiskinan NTB", BPS, Indonesia.
- [5]. Gaspersz, 1998, "Metode Analisis untuk Peningkatan Kualitas", Gramedia PustakaUtama, Jakarta.
- [6]. Menteri Koperasi dan UKM, 2010, "Rencana Strategis Kementerian Koperasi dan UKM tahun 2010-

- 2014”, Kementerian Koperasi dan UKM Indonesia, Jakarta.
- [7]. Sumanth D.J, 1985, “Productivity Engineering and Management”, McGraw-Hill, Inc., Singapore.
- [8]. Tanto D, Dewi SM, Budio SP, 2012, “Faktor-faktor yang Mempengaruhi Produktivitas Pekerja pada Pengerjaan Atap Baja Ringan di Perumahan Green Hills Malang”, Jurnal Rekayasa Sipil Universitas Brawijaya Vol.6 No.1.

Study of Maize-Pulses Intercropping on a Dryland

I K. D. Jaya*, Sudirman, H. Suheri

Faculty of Agriculture University of Mataram, Jl. Majapahit 62 Mataram, Lombok

*Corresponding author: ikdjaya@unram.ac.id

Abstract

This study aimed at studying productivity of intercropping between maize and pulses on a dryland soil. An experiment was conducted in North Lombok (8.253654 S, 116.285695 E) involving maize, mungbean and groundnut crops. The treatments were monocrop maize, mungbean, and groundnut, intercropping maize-mungbean, and maize-groundnut. All the treatments had three replications and the size of the plot for each treatment was 5.0 x 8.0m. The maize crops were planted in a double row pattern (20 x 35cm inside the double row and 70cm between the double rows) while mungbean and groundnut crops were planted at 20 x 20cm with one seed per hole. The results show that maize growth (plant height and leaf number) was negatively affected by mungbean in intercropping but not by groundnut. Intercropping affected severely the yield component (weight of 1000 grains) of groundnut but not that of the mungbean. There was no advantage of intercropping over monocrop in term of land use in growing maize and mungbean since the Land Equivalent Ratio (LER) value was 1.0, and LER for maize-groundnut intercropping was 0.95. The results suggest that maize, mungbean and groundnut are better grown as individual crops rather than as an intercropping in dryland areas.

Keywords: *dryland, groundnut, land equivalent ratio, monocrop, mungbean, productivity*

1. Introduction

Climate change was reported to reduce plant yield because the changes in air CO₂ concentration, temperature, and water availability were faster than the ability of plant to adapt. One of strategic steps to adapt climate change is to plant a number of crops on a piece of land (Lin, 2011). To grow more than one crop on a piece of land can be done with intercropping. This technique has been widely practiced traditionally to increase land productivity as well as to avoid total yield loss. Currently, intercropping has been practiced not only in tropical countries, but it has also been adopted in sub-tropical countries. Acceptability of this technique was mainly due to its ability to maximize the use of available resources, such as; sunlight, water, and nutrition.

In addition to increase plant diversity in a piece of land, intercropping is also used to increase land productivity. Land productivity measurement is usually expressed as a land equivalency ratio (LER). LER compares yields of two or more crop species when they are grown in intercropping and when they are grown separately (monocrop). LER can be calculated based on the formula (Dariush *et al.*, 2006); $LER = \sum (\frac{Y_{pi}}{Y_{mi}})$, where Y_p and Y_m are yields of plants grown in intercropping and monocrop, respectively. Ratio value (i) is a part of LER values, the values of which when are summed in accordance to number of plants in intercropping will result in the value of LER itself.

Maize may be intercropped with other annual crops that are shorter morphologically, such as mungbean and groundnut. In intercropping, plant morphology and age differences determine yields of the component crops. The taller plants may cause shading effect on the shorter ones. Meanwhile, the plants with shorter growing periods can be harvested earlier to

provide earlier cash to the grower before other crops are harvested. This paper discusses the potential of intercropping between maize and pulses (i.e. mungbean and groundnut) on a dryland. Results of this research are expected to be used as references for farmers on a dryland to improve their ability to adapt to the negative impacts of climate change.

2. Materials and Methods

A field experiment was conducted at Gumantar village (8.253654 S, 116.285695 E), Kayangan sub-district, North Lombok, where two intercropping treatments were evaluated, namely maize-groundnut intercropping and maize-mungbean intercropping. Each treatment was set up in three plots of 5 m x 8 m. Maize (NK22) was planted as a double row pattern (with 35 cm x 20 cm spacing within the double rows and 70 cm spacing between double rows) following an East-West orientation, and the pulses (Hypoma-1 for groundnut, and Kenari for mungbean) were planted in a row spacing of 20 cm x 20 cm within the 70 cm spaces between the double rows. This resulted in six (6) pairs of double row maize and five (5) rows of pulses between three double rows of maize, the latter occupying 21% of the total area in the system. Three monocrop treatments (composed of maize, groundnut, and mungbean, respectively) were also provided to calculate the land use efficiency (LER). The overall treatments were: (a) intercrop maize-groundnut; (b) intercrop maize-mungbean; (c) monocrop maize; (d) monocrop groundnut; (e) monocrop mungbean

Fertilizers were given three times. Firstly, fertilizers of N-P-K (15-15-15) Phonska 175 kg/ha and Urea 87.5 kg/ha were applied at planting time for maize. Pulses were fertilized with Phonska 125 kg/ha and Urea 50 kg/ha. Second fertilization was done 28 days after sowing (DAS) with the same dosage of Phonska as the first fertilization and Urea 175 kg/ha for maize. Pulses were fertilized with the same fertilizers and dosages as those at the first one. The third fertilization for maize was done at 56 DAS with 875 kg/ha Urea. The crops were watered by flooding the plots with water pumped from a deep-well pump.

Experimental data were analyzed descriptively and land use efficiency was calculated based on a formula proposed by Dariush *et al.* (2006).

3. Results and Discussion

At the end of the vegetative phase, plant height of maize in monocrop treatment was not different from that in maize-groundnut intercropping. However, maize in maize-mungbean intercrop was shorter than the one in other treatments. Data with the same trend were also observed on the variable of leaf number (Table 1). Meanwhile, maize yield (grain weight per plot) in monocrop treatment was 43.7 kg/40 m² or equivalent to 10.9 ton/ha. This amount was the highest yield potential (11 ton/ha) of maize NK22 as reported by its producing company, PT. Syngenta.

Table 1. Plant height, leaf number, weight of grain per plot, and weight of 1000 grains (\pm standard error) of maize in monocrop and intercropping treatments

Treatments	Observed Variables			
	Plant height (cm)	Leaf number	Grain weight/plot (kg)	Weight of 1000 grains (g)
Monocrop	205.5 \pm 1.76	15.2 \pm 0.42	43.7 \pm 1.86	394.2 \pm 3.15
Mungbean intercropping	188.5 \pm 4.27	14.2 \pm 0.30	33.8 \pm 2.62	389.9 \pm 1.40
Groundnut intercropping	205.3 \pm 0.29	14.8 \pm 0.23	34.3 \pm 1.86	390.5 \pm 4.76

While the yield of maize in maize-mungbean intercrop was exactly the same as that of in monocrop, the yield of maize in maize-groundnut intercrop was a bit higher (i.e 11.1 ton/ha). This was probably due to the fact that groundnut had a better ability to fix nitrogen and to mobilize phosphorus than mungbean, resulted in the nutrients being available for maize in the intercropping system. This finding was in line with the result previously by Whitehead and Isaac (2012) who indicated that legumes were able to increase P absorption by cereal plants in intercropping system.

The decrease of maize yield in intercropping treatment compared with monocrop treatment (Table 1) appeared to be due to the lower population of maize in intercropping treatment. Meanwhile, maize yield component, i.e. weight of 1000 grains was not influenced by intercropping treatment although there was a slight decreased in weight of yield in the two intercropping treatments compared to that in monocrop treatment.

Biomass and yield component of groundnut planted as intercrops were much higher than those of crop planted as monocrop (Table 2). A reduction by as much as 30%, 12.2%, and 14.7% were observed for biomass/m², number of pods/bunch of plant, and weight of 1000 grains, respectively. These decreases were suspected due to light competition between the taller maize crop and the shorter groundnut. Keating and Carberry (1993) reported previously that in intercropping system, the shorter plants will get less sunlight than the taller ones. This fact also shows that, to produce optimally, groundnut requires full sunlight on a dryland in North Lombok district.

Table 2. Plant biomass, yield and yield components of groundnut (±standard error) in monocrop and intercropping treatments

Treatments	Observed Variables				
	Biomass/m ² (kg)	Number of pods/bunch of plant	Pod weight/plot (kg)	Grain weight/plot (kg)	Weight of 1000 grains (g)
Monocrop	2.0±0.19	21.3±0.73	14.2±1.33	9.0±0.78	685.7±44.29
Intercropping	1.4±0.15	18.7±1.91	2.6±0.32	0.9±0.16	584.7±18.81

The difference in pod weight and grain weight per plot between monocrop and intercrop was influenced by the difference in plant counts between the two systems (Table 2). In addition, the effect of maize canopy in intercrop system also influenced yield. This may be demonstrated by calculating plant yield per unit area. Groundnut in the monocrop system yielded 3.6 ton/ha dry pods, compared to only 2.9 ton/ha dry pods in intercrop system. The yield in monocrop system of groundnut was very closed to the maximum yield reported for Hypoma 1, namely 3.7 ton/ha (Anon, 2012). This result indicates that variety Hypoma 1 of groundnut is very suitable to be cultivated on a North Lombok dryland. Dry grain weight per plot in monocrop was 9.0 kg/plot or equal to 2.25 ton/ha.

Table 3. Plant biomass, yield and yield components of mungbean in monocrop and intercropping treatments

Treatments	Observed Variables			
	Biomass/m ² (kg)	Number of pods/bunch of plant	Grain weight/plot (kg)	Weight of 1000 grains (g)
Monocrop	1,7±0,29	20,0±1,15	7,3±0,55	79,9±1,69
Intercropping	1,6±0,09	19,7±0,88	1,6±0,07	79,9±0,61

In contrast to those of groundnut, growth, yield, and yield components of mungbean were not influenced by maize in intercropping (Table 3). These data show that there was no interspecific competition between maize and mungbean in maize-mungbean intercrop. The difference in grain weight per plot (Table 3) appeared to be due to the difference in plot size or the difference in plant numbers per plot. This becomes clear after the grain weight sampled from a same size of unit area of either monocrop or intercropping was measured, resulted in the same weight which was equivalent to 1.8 ton/ha. This yield was considered high for mungbean variety Kenari, which was reported to have the yield potential of up to 2.4 ton/ha with the average being 1.3 ton/ha (Suhartina, 2005). The data strongly support the fact that mungbean variety Kenari is suitable to be cultivated in a North Lombok dryland.

The results show that Land equivalency ratios (LER) were 1.0 in maize-mungbean intercrop, and 0.95 in maize-groundnut intercrop. This means that the same area of land is required in order to get the same yield of individual crop of maize or mungbean planted as monocrop as that in maize-mungbean intercrop. However, in the case of maize-groundnut intercrop, a 5% more land area is required for intercrop system to result in the same yield as that of individual crop planted in monocrop system. These results show that there was no advantage from intercropping of either maize-mungbean or maize-groundnut in terms of land use efficiency on a dryland of North Lombok.

4. Conclusions

Intercropping of maize with pulses on a dryland in North Lombok with technique developed in this study did not give any contributions on land use efficiency. Even in maize-groundnut intercropping, growth ability and yield of individual of groundnut plant decreased. Based on these results, farmers on the dryland of North Lombok are suggested to grow maize, groundnut, and mungbean in monocrop system. Nevertheless, research on maize and pulses cultivation on a dryland needs to be developed as it's important in plant diversification in improving farmers' resilience to overcome the negative impact of climate change.

Acknowledgement

The authors sincerely thank to the University of Mataram for funding this research.

References

- [1] Anon, 2012. Hypoma 1 and Hypoma 2. Superior Peanut Variety Resistant to Leaf Spot and Rust. Indonesia Agency for Agriculture Research and Development. Ministry of Agriculture. <http://en.litbang.pertanian.go.id/news/one/116/> (Accessed on 25 November 2016)
- [2] Dariush, M., M. Ahad, O. Meysam, 2006. Assessing the land equivalent ratio (LER) of two corn (*Zea mays* L.) varieties intercropping at various nitrogen levels in Karaj, Iran. *Journal of Central European Agriculture* 7: 359-364.
- [3] Keating, B.A., P. S. Carberry, 1993. Resource capture and use in intercropping: solar radiation. *Field Crops Research* 34: 273-301
- [4] Lin, B. B., 2011. Resilience in Agriculture through crop diversification: Adaptive management for environmental change. *BioScience* 61: 183-193.
- [5] Suhartina, 2005. Deskripsi Varietas Unggul Kacang-kacangan dan Umbi-umbian. Balai Penelitian Tanaman Kacang-kacangan dan Umbi-umbian, Malang 154p.
- [6] Whitehead, M. and M. E. Isaac, 2012. Effect of shade on Nitrogen and Phosphorus acquisition in cereal-legume intercropping systems. *Agriculture* 2: 12-24

The Performance of Production and Price of Rice In South Sumatra

Desi Aryani^{1,2*}

¹ *Candidat Doctor in Ilmu Pertanian Fakultas Pertanian Universitas Padjadjaran*

² *Lecturer in Program Studi Agribisnis Fakultas Pertanian Universitas Sriwijaya*

* *Email: desiaryaniz@yahoo.com*

Abstract

Availability of basic foodstuffs, especially rice production affected by the amount of rice in an area. South Sumatra province as one of the breadbasket regions should always maintain the stability of foodstuffs, especially rice required by the community. The government is always trying to improve production and keep prices of rice are in the favorable conditions for farmers and consumers. The government will face food price dilemma, where farmers want higher rice prices, but consumers want instead. This paper aim to analyze the performance of rice production, productivity, and the price in South Sumatra. This study is collecting secondary data from BPS, period 2010 until 2014. Statistically, South Sumatra have a surplus of rice every year. In such conditions, the problem of food security in South Sumatra determined more on the aspects of accesibility (people's purchasing power) and continuity of food availability between seasons. South Sumatra province accounted for 21.55 percent of Sumatra's rice production or 5.04 percent of Indonesia's rice production with an average production of 2,170,638 tons per year. South Sumatra rice production on average showed an increasing trend from 2010 to 2014. Compared with the average productivity of Indonesian rice by 5.08 tons per hectare, South Sumatra rice productivity only reached 4.39 tons per hectare. The average price of grain in South Sumatra that was converted rice equivalent is about Rp7,652.31 per kilogram while the average price of rice at Rp8,394.16 per kilogram. It means that there is a differences about Rp741.86 per kilogram. There is a fairly large difference in price between the producer prices to consumer prices, indicating that there are imperfect price transmission from retail market to producers.

Keywords: *foodstuffs, price, production, productivity, rice*

1. Introduction

Accessibility to rice food can be seen from the stability and level of rice prices. Foodstuffs should always be available in sufficient quantity, feasible quality and medically safe for consumption. These factors are economically related to the purchasing power of the people, so the price of food products must be affordable for consumers. Affordable prices does not mean that food prices should always be low or cheap, because it is actually cause many disadvantage on farmers and the ability of national food security, Husodo[1].

South Sumatra is one of the rice producing areas which quite large in Indonesia. South Sumatra became the sixth center of rice production in Indonesia or third outside Java island after South Sulawesi and North Sumatra. In 2008 the South Sumatra province is contribute to 4.82 percent of the national rice production, Aryani [2]. South Sumatra province as one of the breadbasket regions should always maintain the stability of foodstuffs, especially rice required by the community. The government is always trying to improve production and keep prices of rice are in the favorable conditions for farmers and consumers as well. The government will face food price dilemma, where farmers want higher rice prices, but consumers want instead, Yustiningsih [3]. The objective of this study was to analyze the performance of rice production, productivity, and the price in South Sumatra.

2. Materials and Method

This study is collecting secondary data from BPS, period 2010 until 2014. Collection of data is done by using documentation method, it is research method that obtained by collecting data, records and reports objective data obtained from the source. The collected data were processed mathematically and described descriptively. To answer the research objective, it is quantitatively analyzed with descriptive statistics. The results described in descriptive analysis supported by facts and phenomena. Analysis relative deviation from the average price of rice at the level producers (farmers) and consumers which expressed by the standard deviation.

3. Results and Discussion

3.1. Rice Production and Productivity

Availability of basic foodstuffs (rice) affected by rice production in an area. In 2015, the average production of *padi sawah* in South Sumatra reached 4,998 tons per hectare, while the average production of *padi ladang* reached 2,769 tons per hectare, BPS South Sumatera [4]. Data of rice production over the last five years in South Sumatra province than provinces in Sumatra Island and the national rice production can be seen in Table 1.

Table 1 Rice production in Sumatra Island and Indonesia, 2010-2014

Province	Production (Tons)						Percent	Productivity (Tons/Ha)
	2010	2011	2012	2013	2014	Average		
Aceh	992.793	1.112.356	1.122.254	1.227.784	1.141.938	1.119.425	11,11	4,65
North Sumatra	2.247.536	2.263.285	2.331.113	2.338.476	2.276.815	2.291.445	22,75	4,89
West Sumatra	1.387.337	1.430.222	1.485.928	1.524.823	1.580.433	1.481.749	14,71	4,94
Riau	360.670	336.153	321.324	272.382	241.847	306.475	3,04	3,65
Jambi	394.527	405.703	392.228	416.929	417.045	405.286	4,02	4,25
South Sumatra	2.053.136	2.123.542	2.067.438	2.306.776	2.302.299	2.170.638	21,55	4,39
Bengkulu	324.284	315.301	365.090	390.765	372.170	353.522	3,51	4,01
Lampung	1.761.536	1.845.055	1.945.853	2.012.073	2.083.163	1.929.536	19,16	4,92
Babel Island	13.965	9.543	14.051	17.868	14.732	14.032	0,14	2,71
Riau Island	782	767	830	860	880	824	0,01	3,41
Sumatra's Rice Production	9.536.565	9.841.928	10.046.109	10.508.736	10.431.322	10.072.932	100,00	4,18
Indonesia's Rice Production	41.702.898	41.255.882	43.325.813	44.720.889	44.439.842	43.089.065		5,08

Source: BPS, 2015

Over the last five years (2010 to 2014), the average production of rice in Sumatra Island amounted 10,072,932 tons or 23.38 percent of Indonesia's rice production. South Sumatra province contributes 21.55 percent of Sumatra's rice production or 5.04 percent of Indonesia's rice production with an average production of 2,170,638 tons per year. South Sumatra rice production on average showed an increasing trend from 2010 to 2014. This is in line with previous research which of the results shown that the trend of harvested area, production and productivity of rice in South Sumatra showed an upward trend from 1991 to 2010, Aryani, [2].

High rice production in South Sumatra, was not accompanied by high productivity as well. The level of rice productivity in South Sumatra, is not higher than other provinces that have lower production (province of West Sumatra, Lampung and Aceh). Compared with the average productivity of Indonesian rice by 5.08 tons per hectare, South Sumatra rice productivity only reached 4.39 tons per hectare. South Sumatra proclaimed as one of the national food basket, as a regional breadbasket, production of rice from South Sumatra greatly

affect the national rice production. In 2014 rice production reached 2,302,299 tons in South Sumatra contributes 5.18 percent of the total national production amounted 44,439,842 tons. The ability of rice production in South Sumatra varies between regions (districts/cities) and between seasons. There is no clear mechanism rice arrangement in South Sumatra, although the region barns but in real terms still import rice from outside the region and abroad. Rice from South Sumatra sold to other provinces, this is because of almost all the rice producers in South Sumatra bordering to other provinces that have better access in transportation. In line with these studies, the results of research, Aryani [2] concluded that there is rice distribution in and out of South Sumatra Province. Rice that traded on South Sumatra not only from the production of local farmers in the province but also came from outside the province, among others, Lampung and West Java. Likewise the marketing area of rice is not just to local consumers in the province, but also to consumers outside the province, among others, the provinces of Bengkulu, Jambi, Riau and Padang.

3.2. Rice Price

As one of the provinces with a high level of rice production, South Sumatra have a surplus of rice every year. High rice surplus in one area can distinguish two things, the surplus can guarantee the food security of high society in the aggregate. On the other hand a large surplus if it is not accompanied by the ability to distribute the excess production to other areas, it can create excess domestic market demand, consequently the price may fall so low that can adversely affect economic conditions, Majdah [5].

Based on the BPS [6], the average rice retail price in the traditional markets of South Sumatra (Palembang) in 2014 amounted Rp 10,248.70 per kilogram. The price is higher than the average rice retail price in Aceh, Tanjung Pinang, Jambi and Pangkal Pinang, which is not a regional center of rice production in Indonesia. In average from 2010 to 2014, retail price of rice in South Sumatra is amounted Rp 8,413.17, it is higher than the two other provinces in Sumatra Island of Jambi and Pangkal Pinang (Table 2).

Table 2. Average rice retail price and standard deviation in Sumatra Island (2010-2014)

Province/ City	Rice Retail Price (Rp/Kg)						Standard Deviation
	2010	2011	2012	2013	2014	Average	
Banda Aceh	6.993,89	8.247,31	8.643,80	9.264,79	9.299,34	8.489,83	945,55
Medan	6.954,47	7.725,61	7.881,98	8.286,99	8.665,60	7.902,93	644,33
Padang	8.007,47	9.878,17	9.721,15	9.921,76	10.548,13	9.615,34	952,56
Pekanbaru	7.888,78	9.600,82	9.775,81	9.976,67	10.832,45	9.614,91	1.074,58
Tanjung Pinang	9.350,89	8.031,48	8.733,38	9.135,93	9.431,23	8.936,58	573,71
Jambi	7.335,81	7.631,13	8.376,95	8.562,53	8.871,08	8.155,50	646,84
Palembang	6.824,81	7.643,67	8.459,45	8.889,22	10.248,70	8.413,17	1.295,47
Pangkal Pinang	6.712,67	7.667,32	8.430,09	8.655,33	9.151,35	8.123,35	952,87
Bengkulu	6.742,39	7.556,16	8.673,44	9.349,06	10.866,17	8.637,44	1.599,63
Bandar Lampung	6.515,60	10.574,74	11.487,14	12.978,43	13.445,72	11.000,33	2.757,89
Indonesia	7.175,63	8.126,82	8.858,73	9.198,37	9.760,20	8.623,95	1.002,61

Source: BPS, 2015

Agricultural and food products including rice considered relatively homogeneous, the price difference between regions shows distortion caused by the difference in quality, but it probably because of their market power, inefficiency and policy distortions. Marketing margins may be affected by market forces or inefficiency food marketing chain. Competitive market encourages the determination of marketing margin rises, pushing for increased efficiency on the integration of vertical markets from producers to retail in particular for food commodities, Bojnec and Peter [7].

The grain price in producer level and rice price in consumer level are likely to show any differences. From the grain prices data that has been converted to rice equivalent (0.6274%) there is a quite large price difference, it indicates that the presence of imperfect price transmission from retail market to market producers. For five years (2010 - 2014) in South Sumatra, the average price of grain that was converted to rice equivalent is about Rp 7,652.31 per kilogram while the average price of rice at Rp 8,394.16 per kilogram. It means that there is a price difference of Rp 741.86 per kilogram (Table 3).

Table 2. Average Price of Grain and Rice in South Sumatra Toward HPP

Description (Rp/Kg)	2010	2011	2012	2013	2014	Average
Grain Price	4.154,17	4.337,21	4.882,88	5.068,07	5.562,96	4.801,06
Conversion of Rice	6.621,24	6.912,98	7.782,73	8.077,89	8.866,69	7.652,31
Rice Price	6.824,81	7.631,13	8.376,95	8.889,22	10.248,70	8.394,16
Difference	203,57	718,15	594,22	811,33	1.382,01	741,86
Grain HPP	3.300,00	3.300,00	4.150,00	4.150,00	4.150,00	3.810,00
Rice HPP	5.060,00	5.060,00	6.600,00	6.600,00	6.600,00	5.984,00

Source: BPS, 2015

Table 3 shows the gap between producer prices to consumer prices in South Sumatra. From 2010 to 2014 the prices range seen fluctuating and it continues to increase, where in 2010 the difference only amounted Rp 203.57 per kilogram, it increased to Rp 1,382.01 per kilogram in 2014. The determination of HPP by government is expected to help farmers to stabilize prices and fulfill their rice supply in the lean season. But in reality the welfare of farmers is not increased, farmers feel harmed by the policy, Sawit and Halid [8]. HPP determined by the government has always been far below the market price, HPP tend to not responding of price changes in the market. HPP both grain and rice remained unchanged during the period 2010 - 2011 and 2012 - 2014, does not follow the dynamic changes in the market prices that continue to rise.

4. Conclusion

South Sumatra province has an average rice production of 2,170,638 tons per year, it contribute to 21.55 percent of Sumatra's rice production or 5.04 percent of Indonesia's rice production. South Sumatra's rice production showed an increasing trend from 2010 to 2014. Compared with the average productivity of Indonesian rice by 5.08 tons per hectare, rice productivity of South Sumatra only reached 4.39 tons per hectare.

Average grain price in South Sumatra that was converted to rice equivalent is about Rp 7,652.31 per kilogram while the average rice price is Rp 8,394.16 per kilogram. It means that there is a difference about Rp 741.86 per kilogram. There is a fairly large price difference between the producer prices to consumer prices, it is indicate imperfect price transmission from retail to producer market. HPP determined by the government has always been well below the market price, HPP tend to not responding of price changes in the market.

References

- [1] S.Y. Husodo, Masa Depan Pertanian Indonesia, Makalah Seminar Nasional dan Musyawarah Wilayah II DPW Jawa POPMASEPI di Universitas Islam Negeri Syarif Hidayatullah di Jakarta, 2003.
- [2] Aryani, D, Ketahanan Pangan di Sumatera Selatan Ditinjau dari Tren Produksi Beras dan Stok Beras Pedagang, Prosiding Seminar Nasional Agribisnis: Kristalisasi Paradigma Agribisnis dalam Pembangunan dan Pendidikan Tinggi, Bogor 18 April 2015.
- [3] F. Yustiningsih, Analisa Integrasi Pasar dan Transmisi Harga Beras Petani-Konsumen di Indonesia, Tesis, Fakultas Ekonomi, Universitas Indonesia, 2012.
- [4] Badan Pusat Statistik Sumatera Selatan, Provinsi Sumatera Selatan dalam Angka 2015, 2015.
- [5] M.Z. Majdah, Perspektif Perdagangan Beras antar Pulau, Jurnal Analisis 4(2):111-123. 2007.
- [6] Badan Pusat Statistik, Database, www.bps.go.id/site/pilihdata (diakses tanggal 7 Mei 2015), 2015.
- [7] S. Bojnec and G. Peter, Vertical Market Integration and Competition: The Meat Sector in Slovenia. Agricultural and Food Science, 14(2005):236-249, 2005.
- [8] M.H. Sawit and H. Halid, Arsitektur Kebijakan Beras di Era Baru, IPB Press, 2010.

Growth Performance of Broiler Chickens Fed Diets Containing Putak and Rice Bran Supplemented With Cellulase, Xylanase, -Glucanase, Pectinase, Phytase, Protease and Amylase

Nalle Catootjie Lusje¹, Netty Ermawatty², Marlin R. K. Yowi³, Defrys R. Tulle⁴

¹Feed Technology Study Program, Animal Husbandry Department, Polytechnic of Agriculture Kupang, Prof. Herman Yohannes St, Lasiana,, Kupang-NTT, Indonesia

² Study Program, Animal Husbandry Department, State Polytechnic of Jember, Mastrip St, Jember-East Java, Indonesia

³ Animal Health Study Program, Animal Husbandry Department, Polytechnic of Agriculture Kupang, Prof. Herman Yohannes St, Lasiana Kupang-NTT, Indonesia

⁴ Animal Production Study Program, Animal Husbandry Department, Polytechnic of Agriculture Kupang, Prof. Herman Yohannes St, Lasiana, Kupang-NTT, Indonesia

*Email: catootjienalle@gmail.com

Abstract

The main objective of the present study was to evaluate the growth performance of broilers fed diets based on putak and rice bran supplemented with multy-enzymes. Three treatment diets based on maize--putak-rice bran-soybean meal were formulated to meet or under NRC (1994) recommendations for major nutrients. All diets were offered *ad libitum* in crumble form to four replicate pens of broilers (10 birds/pen) from day 1 to d 35 post-hatch. The results showed that significant differences ($P>0.05$) were observed in growth performance of broilers. Birds fed positive control diets had higher ($P<0.05$; $P<0.01$) body weight gain and feed per gain than those fed negative control diet with or without enzymes. The average body weight gain of birds fed positive control diet was 395.7 g/bird (21d); 873.8 g/bird (0-35d), followed by negative control diet supplemented with enzymes, 308.5 g/bird (21d); 737.3 g/bird (35d) and the lowest was those fed negative control diet without enzyme supplementation, 286.3 g. Feed intake of birds fed control positive control diets were comparable ($P>0.05$) than than those fed negative control diet with or without enzymes. Birds fed positive control diets were more efficient in utilising diets (3.211; 3.452) compared to two other treatments. No significant differences ($P>0.05$) were found in mortality rate among all treatment diets on day 21 dan 35 post hatch. In conclusion, modification of nutritional composition of broiler diets lower than that of required and supplementation of enzymes in broiler diets based on local feed ingredients causes an improvement in growth performance of broiler during starter and growing periods even though the results were not as good as the growth performance of broilers given diet with the nutritional composition as standard nutritional requirements.

Keywords: *broilers, BWG, FCR, FI, enzymes, putak, rice bran*

1. Introduction

Poultry feed industry in Indonesia is still mainly depending on maize as the main energy source in the diets formulated for poultry. The choice of maize as the main energy source due to its high metabolisable energy, digestibility and palatability. However, the availability of maize in Indonesia is fluctuative due to the season, which leads to unstable price along the year, and even tend to increase every year. In addition, this condition causes poultry feed industries in Indonesia has to import maize from overseas. As a result it will increase the price of poultry feed. Because of that, it is necessary to use the alternative energy feed ingredients to partly substitute the proportion of maize in poultry ration.

NTT has prospective alternative feed ingredients which are putak, and rice bran that has been nutritionally evaluated for their potential using [1,2,3,4]. In the previous experiments, it was found that putak contains nitrogen correction apparent metabolisable energy (AMEn) 2774 kcal/kg DM, crude protein (CP) 36.6 g/kg, lysine 1.2 g/kg, met+cys 0.9 g/kg, crude fibre (CF) 99.5 g/kg, NDF 81.4 g/kg, crude lipid (CL) 3.2 g/kg, Ca 18.0 g/kg and P 4.2 g/kg. The inclusion level of putak in poultry diet to was found up 200 g/kg without giving negative impact on growth performance of broilers during 21d experimental periods. Rice bran contains nitrogen correction AMEn 1908 kcal/kg DM, CP 74.1g/kg, lysine 0.9 g/kg, meth+cystine 1.7 g/kg, CF 314.8 g/kg, NDF 616.8 g/kg, CL 44.2 g/kg, Ca 15.3 g/kg and P 6.4 g/kg [2]

The improvement of nutritional value of putak and rice bran through fermentation with *Aspergillus niger* has been conducted [1,2]. The result indicated that fermented rice bran and fermented putak have higher nutritional value compared to raw putak and rice bran. The AMEn of putak increased after fermentation from 2774 to 2802 kcal/kg DM . While, for rice bran increased from 1908 to 2922 kcal/kg DM. In addition, fermented rice bran can be included up to 250 g/kg in broiler starter diet.

The improvement of the nutritional value of feed ingredients can be conducted through the supplementation of enzymes. Research about using enzymes in poultry diet based on maize-soybean meal has been conducted by many researchers, but using of enzymes in poultry diets based on maize-putak-rice bran and soybean meal is still limited. This become the main reason why this research was conducted. The main objective of this research was to evaluate the evaluate the production performance of broilers fed diets based on putak and rice bran supplemented with multy-enzymes.

2. Materials and Methods

All experimental procedures were approved by the Gadjah Mada University Ethical Clearance Committee (Certificate Number 00013/04/LPPT/VII/2016).

Ingredients: The feed ingredients included putak and rice bran which were from Kupang area. Before incorporation into assay diets, putak was ground by putak grinder (Fig 1).



Figure 1. Putak processing

Birds and housing: Total of 120 day-old broilers (mix male and female, CP 707) obtained from local commercial hatchery were assigned on the basis of body weight to the 12 floor pens (10 birds/pen) in open housing. The temperature and relative humidity were controlled by thermo-hygrometer. The birds received constant light and, were allowed free access to the diets and water for 24 h per day.

Diets: Total of three diets was mixed; on control positive diet based on maize-putak-rice bran-soybean meal was formulated to meet the NRC standard, two negative control diets were formulated under the NRC standard. The multy-enzymes supplementation was included in one of the negative control diet (Table 1 and 2). The diets were pelleted and then crumbled. Each of the three dietary treatments were randomly assigned to four pens containing 10 chicks each, and the diets were fed from day 1 to 35.

Table 1. Treatment diets (starter, 0-21 day)

Feed ingredients	Positive Control (g/kg)	Negative control (g/kg)	Negative control+ multy-enzymes (g/kg)
Maize	417.0	358.7	358.7
Rice bran	80.0	100.0	100.0
Putak, 3,6% CP	82.5	150.0	150.0
Soybean meal, 44% CP	282.6	272.5	272.5
Meat and Bone Meal	72.5	64.0	64.0
Vegetable oil	51.5	44.9	44.9
DL-Methionine 99%	1.50	1.20	1.20
L-Lysine	1.50	2.00	2.00
Limestone	1.30	0.50	0.50
Dicalcium phosphate (DCP)	3.70	-	-
Salt	2.50	2.50	2.50
Sodium bicarbonate	4.00	7.00	5.00
Vitamin-Mineral Premix	3.00	3.00	3.00
Multy-enzymes (Alltech SSF)*)	-	-	0.20
Total	1000	1000	1000
Calculated nutritional composition			
AME (Kkal/kg)	3,100	3,025	3,025
Crude Protein (g/kg)	210	200	200
Lysine (g/kg)	12.7	12.7	12.7
Met + Cys (g/kg)	9.7	9.9	9.9
Ca (g/kg)	10.2	10.0	10.0
Av P (g/kg)	4.8	3.9	3.9

Nutritional composition***) (Laboratory analysis, g/kg DM)			
Dry Matter	965.5	968.2	976.4
Crude Protein	201.7	198.7	201.2
Crude Lipid	93.00	90.00	88.70
Crude Fibre	33.1	31.3	30.2
ADF	109.1	112.6	112.6
NDF	240.9	255.4	231.2
Ash	122.4	127.8	115.1
Ca (g/kg)	9.94	8.98	8.50
P Total (g/kg)	5.59	4.96	492

*) Each kg of Sanmix: Vitamin A 1.250.000 IU, vitamin D3 250.000 IU, Vitamin E 750 IU, vitamin K 200 mg, vitamin B1 150 mg, vitamin B2 500 mg, vitamin B6 500 mg, vitamin B12 1200 mg, vitamin C 3000 mg, Ca-d-pantothenate 500 mg, Niacin 3500 mg, Methionine 3500 mg, lysine 3500 mg, manganese 10.000 mg, iron 2500 mg, Iodine 20 mg, Zinc 10.000 mg, Cobalt 20 mg, Copper 300 mg da, Antioxidant 1000 mg.

**)Alltech SSF: Cellulase, Xylanase, Betaglucanase, Pectinase, Phytase, Protease and Amilase

***) Lab kimia dan makanan ternak, Fapet-Unhas, Makassar and Lab Nutrisi dan pakan ternak Politani Kupang

Tabel 2. Treatment diet (Grower, 22-35 day)

Feed ingredients	Positive Control (g/kg)	Negative control (g/kg)	Negative control+ multi-enzymes (g/kg)
Maize	41.46	41.31	41.29
Rice bran	9.00	10.00	10.00
Putak, 3,6% CP	9.00	10.00	10.00
Soybean meal, 44% CP	27.30	27.49	27.49
Meat and Bone Meal	6.45	5.00	5.00
Vegetable oil	6.00	5.30	5.30
DL-Methionine 99%	-	-	-
L-Lysine	-	-	-
Limestone	0.20	0.30	0.30
Dicalcium phosphate (DCP)		0.01	0.01
Salt	0.25	0.25	0.25
Sodium bicarbonate	0.04	0.04	0.04
Vitamin-Mineral Premix*	0.30	0.30	0.30
Multy-enzymes (Alltech SSF*)	-	-	0.02
Total	1000	1000	1000
Calculated nutritional composition			
AME (Kkal/kg)	3,164	3,105	3,104
Crude Protein (g/kg)	200	194	194
Lysine (g/kg)	11.1	10.9	10.9
Met + Cys (g/kg)	8.2	8.3	8.3
Ca (g/kg)	9.4	9.0	9.0
Av P (g/kg)	3.9	3.6	3.6

Nutritional composition***) (Laboratory analysis, g/kg DM)			
Dry Matter	951.3	950.4	957.8
Crude Protein	200.8	184.3	204.8
Crude Lipid	86.4	82.5	81.1
Crude Fibre	28.7	29.6	27.8
ADF	98.3	121.3	98.6
NDF	263.9	195.8	204.3
Ash	106.2	112.0	108.4
Ca (g/kg)	7.8	7.7	7.9
P Total (g/kg)	3.8	5.5	3.7

*) Each kg of Sanmix: Vitamin A 1.250.000 IU, vitamin D3 250.000 IU, Vitamin E 750 IU, vitamin K 200 mg, vitamin B1 150 mg, vitamin B2 500 mg, vitamin B6 500 mg, vitamin B12 1200 mg, vitamin C 3000 mg, Ca-d-pantothenate 500 mg, Niacin 3500 mg, Methionine 3500 mg, lysine 3500 mg, manganese 10.000 mg, iron 2500 mg, Iodine 20 mg, Zinc 10.000 mg, Cobalt 20 mg, Copper 300 mg da, Antioxidant 1000 mg.

**)Alltech SSF: Cellulase, Xylanase, Betaglucanase, Pectinase, Phytase, Protease and Amilase

***) Lab kimia dan makanan ternak, Fapet-Unhas, Makassar and Lab Nutrisi dan pakan ternak Politani Kupang

Measurements: Body weights and feed intake were recorded at day 21 and 35 during the experiment. The weight gain and feed intake data were used to calculate feed per gain per treatment group.

Statistical analysis: The pens means were used to derive performance data. The data of performance was analyzed by one-way analysis of variance (ANOVA) using the General Linear Model procedure of SAS [5]. Differences were considered to be significant at $P < 0.05$) and significant differences between means were separated by the Fisher's Least Significant Difference Test (LSD).

3. Results and Discussion

The effects of dietary treatments on the performance of broilers are presented in Table 3. As can be seen from Table 3., during 21 day and 35 day of experiment, birds fed positive control diets had significantly differences ($P < 0.05$) in performances compared to those fed negative control diets with or without enzymes. The weight gain of birds fed positive control diets were higher ($P < 0.05$; $P < 0.01$) than those fed negative control diets with or without multy-enzymes. On the other hand, feed intake of birds given negative control diets with or without multy-enzymes was comparable ($P > 0.05$) from those fed positive control diets during starter and growing period. Feed per gain of bird fed positive control diet was significantly higher ($P < 0.05$; $P < 0.01$) than that of two other treatments. No significant difference ($P > 0.05$) was found in mortality rate in all treatment diets during starter and growing periods.

Table 3. Growth performance of broilers fed diets containing putak and rice bran supplemented with multy-enzymes (day 21 and 35)

Treatment diets	BWG (g/bird)	Feed intake (g/bird)	Feed per gain (g/g)	Mortality (%)
0-21 day				
Positive control	395.8 ^a	1240	3.211 ^a	0.0%
Negative Control	296.3 ^b	1238	4.451 ^b	0.0%
Negative control + multy-enzymes	308.5 ^b	1233	4.055 ^b	0.0%
Probability	*	NS	*	NS
0-35 day				
Positive control	873.8 ^a	3014	3.452 ^a	0.0%
Negative Control	587.8 ^c	3078	5.309 ^b	0.0%
Negative control + multy-enzymes	737.3 ^b	3055	4.143 ^b	0.0%
Probability	**	NS	**	NS
^{a,b} Means of column with the superscripts significant defference ($P < 0.05$), NS: Not significant ($P > 0.05$)s				
^l each value is the average of 4 replicates (10 birds/replicate)				

It can be seen from Table 3., the highest body weight gain was found in birds fed positive control diet, followed by those fed negative control diets supplemented with enzymes, while the lowest was found in birds given negative control diet without enzyme supplementation. It is interesting to note that numerically the body weight gain of birds received negative control diet with enzymes was higher to those fed negative control diet without enzymes during the starter period.

Regarding feed per gain, birds given positive control diets had the most efficient feed per gain, which was 3.211 (0-21 d) and 3.452 (0-35 d), followed by negative control diet plus

multy-enzymes and negative control diet without enzymes, which were 4.055 and 4.451, respectively. It is interesting to note that there was an improvement in feed per gain in negative control diet plus enzymes. This result indicated that multi-enzymes added in the diet improved the digestibility of nutrients, especially fibre, protein and starch which leads to the higher availability of those nutrients. The improvement of starch digestibility, as a result of amylase in the cocktail enzymes, caused the improvement of apparent metabolisable energy in the ration. Protease increased the digestibility of diet protein that can lead to the increase of body tissue of broilers. The result of this experiment agreed with previous research [6,7] who explained that the enzyme supplementation in poultry diets will 1) destroy or reduce the anti-nutritional factors in ration, 2) improve the availability of nutrients bound by cell wall that rich in fibre, 3) improve gut health, 4) increase the the amount of endogen enzymes produced by birds to support the hydrolysis of nutrient in the gut.

The worst growth performance in negative control diet without enzyme supplementation was due to the nutritional composition which was under NRC requirement, especially apparent metabolisable energy and calcium requirement, which were 3025 kcal/kg DM and 3.9 g/kg, respectively. Low calcium caused an increase in Ca:Av P ratio, which can impair the nutrient metabolism. Better result of performance in birds fed negative control diet plus multy-enzyme was due to the improvement in nutrient availability that can recover the nutrients which were under NRC requirements.

4. Conclusions

Modification of nutritional composition of broiler diets lower than that of required and supplementation of enzymes in broiler diets based on local feed ingredients causes an improvement in growth performance of broiler during starter and growing periods even though the results were not as good as the growth performance of broilers given diet with the nutritional composition as standard nutritional requirements.

References

- [1] Nalle, C.L. dan M. R.K Yowi., “Nilai Nutrisi Dedak Padi Fermentasi Bagi Ternak Ayam Broiler: *Komposisi Nutrisi dan Performans Produksi-2014*. Prosiding Seminar Nasional: Peranan Sains dan Teknologi untuk Mendukung Pembangunan Berkelanjutan 15-16 Oktober 2014. Volume I: Bidang Sains. Undana Press, 2014., pp. A-41-A-48.
- [2] Nalle, C.L., M. R.K Yowi and A. Widu., “Nutritional Value of Raw and Processed Putak and Saga Bean for Broiler Chickens-2015. *Proceeding International Seminar on Tropical Naturak Resources, 2015*. “Toward Sustainable Utilisation of the Tropical Natural resources for a Better Human Prosperities”. University of Mataram Indonesia June 10-13, 2015pp. 394-406.
- [3] Nalle, C.L. dan M. R.K Yowi., “Pengaruh Penambahan Enzim Amilase, Protease, Xilanase dan Fitase terhadap Performans Pertumbuhan Ayam Broiler, 2014”. *Prosiding Seminar Nasional Fakultas Kedokteran Hewan Undana Ke-2: Penerapan Konsep One Health dalam Penanganan E Diseases Skala Nasional dan Global*. 30 Oktober 2014, pp.21-30.
- [4] Nalle, C.L., M. R.K Yowi and D. Tulle. “Pengaruh Level Pemberian Putak Terhadap Performans Produksi Ternak Ayam Broiler”. *Laporan Akhir Penelitian BOPTN, 2012*. Politeknik Pertanian Negeri Kupang.
- [5] SAS Institute. *SAS/STAT® User’s Guide: Statistics. Version 6.12*. SAS Institute Inc., 1997. Cary, NC, USA.
- [6] McCleary, B. V.,”Analysis of feed enzymes. In: Bedford, M. R. and G. G. Partridge (eds): *Enzymes in Farm Animal Nutrition*”, 2001. CABI Publishing.
- [7] Sheppy, C. (2001). The current feed enzyme market and likely trend. In: “*Enzymes in farm animal nutrition*”. Bedford, M. R. and partrige, G. G., CASI, Walling Ford, PP: 4-10.

Growth Performance of Red Rice as Affected by Insertion of Peanut Row between Double and Triple-Rows of Rice in Aerobic System on Raised-Beds

Nihla Farida¹, Hanafi Abdurrachman¹, V.F. Aris Budianto¹,
Wayan Wangiyana^{1*}

¹*Faculty of Agriculture, University of Mataram, Jln. Majapahi no. 62, Mataram, NTB, Indonesia*

** Email: w.wangiyana@unram.ac.id*

Abstract

This study aimed to examine the effects on rice growth performance of inserting a row of peanut plants between double and triple-rows of a promising red rice line in an additive intercropping with peanut in an aerobic rice system on raised beds, by conducting a field experiment in Narmada (West Lombok, Indonesia), from June to October 2016. The experiment was designed according to Split Plot design testing two treatment factors, i.e. patterns of rice rows (P) as the main plot factor (P1= double and P2= triple rows) and timing of peanut planting (T) as the sub-plot factor (T0= without peanut; T1= planting peanut 1 week, T2= 2 weeks, and T3= 3 weeks after planting (WAP) of sprouting red rice seeds). Results indicated that triple row pattern of red rice resulted in higher number of tillers and panicles than those in double row pattern, and additive intercropping by inserting a row of peanut plants between the double and triple rows of rice either at two or three weeks after planting of rice seeds could significantly increase growth, tiller number, and panicle number of red rice plants. However, the two treatment factors showed interaction effects only on the average growth rate (AGR) of leaf number, leaf number at 8 WAP, and numbers of tillers and panicles per clump at seed filling stage, which were highest when peanut was relay planted two weeks after planting red rice in the triple row pattern or three weeks in the double row pattern of red rice.

Keywords: *additive intercropping, aerobic rice, peanut, red rice*

1. Introduction

Rice is generally cultivated under conventional techniques (with flooded irrigation, and even the water continuously flows between plots) in the lowland paddy fields. Thus irrigation water requirement for rice cultivation is very high but rice productivity is low, with an average of 4.98 t/ha in Indonesia in 2011 [1].

With the conventional techniques, it has also been proved in Madagascar that rice productivity is constantly low, and even tends to decline from year to year if without high input of inorganic fertilizers. With the technique of SRI (System of Rice Intensification), in which rice is irrigated with alternating thin-flooding and drying during the vegetative stage followed by thin flooding during the reproductive phase, and the use of composted manure, it has been demonstrated in Madagascar that rice productivity can be improved. A farmer after applying the SRI technique for 6 years, obtained grain yield of 2.74 ton in a paddy area of 0.13 ha (equivalent to 21 t/ha), but with the conventional techniques in the adjacent plots, rice yield was an average of 2.6 t/ha [2].

In addition to SRI technique, researchers have started to develop aerobic rice cultivation techniques, in which rice is cultivated without flooding and without puddling [3], for example on permanent raised beds. With raised beds, watering can be done through a ditch between beds [4]. Since there is no flooding, the aerobic rice can be intercropped with legume crops,

which are capable of fixing atmospheric nitrogen. In addition, legumes also generally establish symbiosis with arbuscular mycorrhizal fungi (AMF), which are capable of increasing the availability of phosphate to their host plants [5]. In intercropping systems, there are great opportunities for the transfer of nutrients between intercropped plants [6,7,8], and the transfer was reported to occur through AMF hyphae infecting adjacent roots of both types of plants intercropped [9,10]. This study aimed to examine the effects on rice growth performance of inserting a row of peanut plants between double and triple-rows of a promising red rice line in an additive intercropping with peanut in an aerobic rice system on raised beds.

2. Materials and Methods

The field experiment in this study, carried out in the experimental paddy field in Narmada (Lombok, Indonesia) from June to October 2016, was arranged according to Split Plot design, testing two treatment factors, namely: the patterns of rice rows (B) as the main plot (B1= double row, B2= triple row), and intercropping (T) with peanut plants inserted between the double or triple rows of rice plants at various ages rice plants (T0 = without intercropping, T1= additive intercropping with peanut, in which peanut was planted one (1) week after planting (WAP) sprouting rice seeds, T2= planting peanut at 2 WAP, T3= planting peanut at 3 WAP). Thus there were eight treatment combinations, and each combination was made in 3 replications (blocks), so there were 24 treatment beds.

For planting the red rice, 24 raised beds were created with a size of 3.20 m x 1.00 m separated by surrounding furrows of 25 cm width and 20 cm depth. With the basic plant spacing of 20 cm x 20 cm, then there were 80 clumps of rice per beds. Double rows were made by moving every even row 5 cm towards odd rows, so that the distance was 15 cm within a double-row and 25 cm between double-rows, in which peanut plants were inserted. Similarly, between-row distance within a triple row was also 15 cm but between triple-rows it was 30 cm, in which peanut plants were inserted. At planting rice, 40 g “Bokashi” (EM-4 fermented compost of cattle manure) was dibbled into each planting hole, and then 3-4 sprouted seeds of the promising amphibious red rice line “Amp-G4” were planted in the compost and covered with surrounding soil. One week after planting (WAP) rice, thinning was done to leave only two rice plants per hill. Insertion of peanut plants (relay planting of peanut) was started at 1 WAP (T1), then 2 WAP (T2) and 3 WAP (T3) of planting rice, by dibbling 3-4 peanut seeds of Hypoma-1 variety between the double and triple rows of rice plants with 20 cm within row spacing, then peanut seeds in the planting holes were covered with 1 table spoon of rhizosphere soil freshly taken from ready-to-harvest Hypoma-1 peanut plants having many root nodules growing on the same land area. After one week, thinning was also done to allow only 2 peanut plants to grow per hill.

Rice plants were fertilized with Phonska (15-15-15) of 1.2 g/clump (300 kg/ha) at 1 WAP, and Urea (45% N) at 4 WAP and 7 WAP of 0.4 g/clump each (100 kg/ha), whereas peanut was fertilized only with Phonska of 1.2 g/clump. Those fertilizers were dibbled 7 cm beside the plants at 7 cm depth. Watering was done by continuous flowing of irrigation water through the furrows surrounding the raised beds by maintaining water surface 8-10 cm below the bed surface. Weeds were controlled by removing them manually, while the pests (*Leptocorisa* plant-hoppers) were controlled by alternating spray of the insecticides Decis 25 EC and combination of Amcothene 75 SP + Yasithrin 30 EC with an interval of one week during the attack. To keep the rice from bird attack, the rice plants were covered with nets of 1.5 inch mesh size. The Amp-G4 red rice was harvested 110 days after planting (DAP).

The variables measured were plant growth (plant height, number of leaves, number of

tillers, which were measured every week), and number of panicles per hill at seed filling stage. Data were analyzed with analysis of variance (ANOVA) and test Honestly Significant Difference (HSD) at 5% level of significance, using CoStat for Windows ver. 6.303. The average growth rate (AGR) was measured with slope coefficient using regression analysis.

3. Results and Discussion

Based on the ANOVA results, it can be seen from Table 1 that both treatment factors tested, namely intercropping and pattern of rice rows, showed significant interaction effects only on the average growth rate (AGR) of leaf number, leaf number at 8 MST, tiller number at 12 MST, and number of panicles per hill, with the main effects were also significant, in which the pattern of "triple-rows" gives higher average values, while among the multiple cropping treatments, T3, i.e. relay planting of peanut 3 weeks after planting red rice, shows the highest average values, whereas T0, i.e. without intercropping, shows the lowest average values.

Table 1 Average growth rate (AGR) of plant height (PH), leaf number (LN), and tiller number (TN), and plant height (PH) at 8 & 12 WAP; leaf number (LN) at 8 & 12 WAP; tiller number (TN) at 8 & 12 WAP; and number of panicle per clump

Treatments:	AGR PH		PH 8 WAP		PH 12 WAP		AGR LN		LN 8 WAP		LN 12 WAP		AGR TN		TN 8 WAP		TN 12 WAP		Panicle/clump	
Intercropping:																				
T0	1.31	a	85.3	a	112.5	a	0.91	b	42.2	c	55.2	b	0.38	b	16.9	c	17.5	c	16.2	c
T1	1.40	a	85.7	a	107.5	a	0.97	b	47.4	b	60.4	ab	0.42	b	19.4	bc	24.2	b	23.3	b
T2	1.37	a	83.8	a	113.8	a	1.00	b	49.4	b	61.8	a	0.45	b	20.7	ab	27.2	a	25.8	a
T3	1.27	a	79.7	a	114.0	a	1.18	a	54.2	a	65.7	a	0.53	a	23.0	a	28.3	a	26.7	a
HSD 5%	ns		ns		ns		0.17		4.6		6.6		0.08		2.7		2.6		2.1	
Row pattern:																				
Double	1.28	a	79.1	b	110.1	a	0.91	b	43.1	b	56.4	a	0.42	b	19.3	b	22.9	b	21.7	b
Triple	1.39	a	88.2	a	113.8	a	1.13	a	53.5	a	65.1	a	0.47	a	20.7	a	25.7	a	24.3	a
HSD 5%	ns		3.1		ns		0.13		9.9		ns		0.03		0.4		2.5		2.6	
Interactions	ns		ns		ns		*		**		ns		ns		ns		***		***	

Remarks: AGR= average growth rate (per day); PH= plant height; LN= leaf number; TN= tiller number; WAP= weeks after planting; ns = non-significant ANOVA; *, **, *** = significant at p<0.05, p<0.01, p<0.001, respectively; Mean values in each column followed by the same letter are not significantly different between levels of a treatment factor based on its Tukey's HSD test

When the interaction effects are examined in more closely it can be seen from Fig. 1A the AGR of leaf number was the highest on red rice plant intercropped with peanut in which peanut was planted when red rice plant already at the age of 3 WAP in the triple-row pattern (T3). Leaf number at 8 WAP was also highest in the same treatment combination (Fig. 1B). However, there are different patterns of interaction effects between the two factors on tiller number (Fig. 1C) and panicle number per clump (Fig. 1D), in which the interaction effects are more distinct between treatment combinations. In terms of panicle number per clump at seed-filling stage, which is a main component of grain yield, it can be seen from Fig. 1D that the highest number of panicles was in triple-row and the rice crops were additive intercropped with peanut planted at 2 weeks after planting rice (T2), but in the double-row pattern, the

highest number of rice panicle was on red rice plants additive intercropped with peanut planted at 3 weeks after planting rice (T3). This means that the width of the peanut growing area had significant effects on the direction of interactions between the component crops in the intercropping system. In the double-row pattern the width of area in which peanut plants were inserted after few weeks of planting rice was 25 cm and this was shared by three clumps of plants, i.e. one peanut and two rice plants, while in the triple-row pattern, the area was wider, i.e. 30 cm, shared by the same number of plants. Thus, relay planting of peanut plants, i.e. planting peanut in established rice crops, in the double-rows of the red rice plants is most beneficial to rice at later time, i.e. 3 weeks after planting rice (T3), while in the triple-rows of the red rice plants, relay planting of peanut plant is most beneficial to rice at earlier time, i.e. 2 weeks after planting rice (T2).

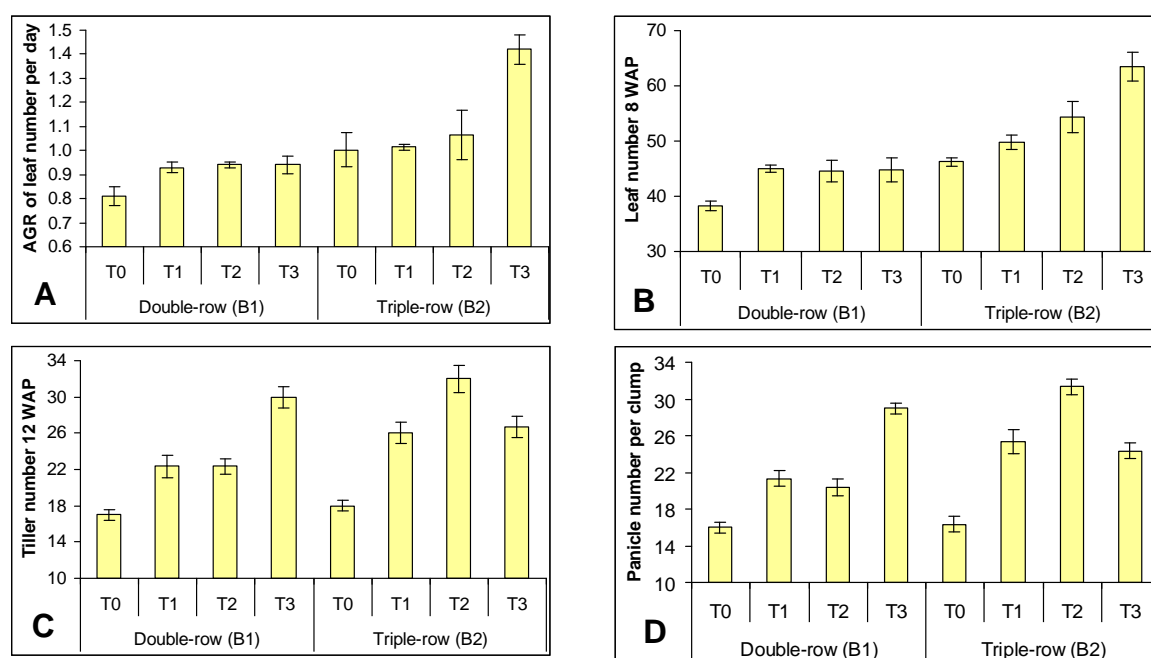

Figure 1 Interaction effects between row pattern and intercropping on AGR of leaf number per day, leaf number per clump at 8 WAP, tiller number per clump at 12 WAP, and panicle number per clump at the seed-filling stage, based on the average values (Mean \pm SE).

Some researchers have reported that intercropping cereals with legume crops can lead to the transfer of nitrogen (N) nutrient from rhizosphere of legumes to the roots of cereal crops, resulting in higher N uptake by the intercropped cereals compared with the monocrop cereals [6,11,7,8], and the transfer is facilitated by AMF associations [9,10], and both rice and peanut are hosts of AMF. It could also be seen from the color of the red rice leaves in this field experiment during their vegetative growth stages that leaves of the intercropped rice plants were greener than those in the monocrop stand. In this study, at the time of planting, peanuts were also inoculated with rhizosphere soil biota and root fragments of peanut plants of the same variety having many root nodules, causing the peanut plants in this study also produced many root nodules, and because they grew in an aerobic conditions, i.e. no flooded conditions on the raised beds, it means that the peanut plants could actively fix atmospheric N₂.

From the development of numbers of rice leaves that were still green (Fig. 2), it can be seen that the intercropped rice plants constantly showed higher leaf number, and between the two row patterns, the triple row showed higher numbers of rice leaves that were still green

until the age of 12 WAP. This indicates some N contribution of relay intercropping of peanut to N nutrition of the rice plants, and between the two row patterns, the triple row pattern seems to have more benefits of relay intercropping the red rice plants with peanut plants.

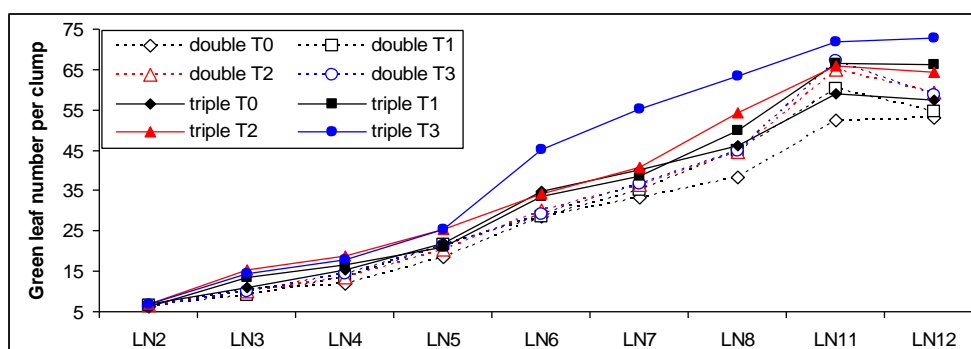

Figure 2 The development in the number of rice leaves that are still green from 2 to 12 WAP between treatment combinations of row patterns and additive intercropping (LN = number of green leaves)

4. Conclusion

Based on the results it can be concluded that relay additive intercropping of red rice with peanut plants in an aerobic system significantly improved growth and panicle number of rice, and between the two row patterns of rice planting, it seems that the rice plants have the highest benefits from the intercropping when peanuts are relay planted at 2 weeks after planting rice in the triple-row pattern or 3 weeks after planting rice in the double-row pattern.

Acknowledgement

Through this article the authors would like to thank the Rector of the University of Mataram for funding this research project through the “PNBP” Research Grant, with the Contract Agreement, No. **167J/SP-BLU/UN18.12.2/PL/2016**.

References

- [1] BPS, *Statistik Tanaman Pangan, 2011*. Biro Pusat Statistik, Indonesia. <http://www.bps.go.id>.
- [2] N. Uphoff, “Question and answer about the System of Rice Intensification (SRI) for raising the productivity of land, labor and water”. CIIFAD Paper, 2002 (<http://ciifad.comell.edu/sri/sripapers.html>).
- [3] R. Prasad, *Aerobic Rice Systems. Advances in Agronomy*, **111**: 208-233 (2011).
- [4] N.W.D. Dulur, I.G.M. Kusnarta, dan W. Wangiyana, “Aplikasi Pasir dan Pupuk Kandang pada Bedeng Permanen untuk Perbaikan Sifat Tanah dan Pertumbuhan Padi di Lahan Vertisol Tadah Hujan Lombok”. *Agroteksos*, 25(2): 102-108 (2015).
- [5] S.E. Smith and D.J. Read, *Mycorrhizal Symbiosis*. Third Edition. London, UK: Academic Press, 2008.
- [6] K. Fujita, S. Ogata, K. Matsumoto, T. Masuda, G.K. Ofofu-Budu, and K. Kuwata, “Nitrogen Transfer and Dry Matter Production in Soybean and Sorghum Mixed Cropping System at Different Population Density”. *Soil Sci. Plant Nutr.*, 36(2): 233-241 (1990).
- [7] G.X. Chu, Q.R. Shen, and J.L. Cao, “Nitrogen fixation and N transfer from peanut to rice cultivated in aerobic soil in an intercropping system and its effect on soil N fertility”. *Plant and Soil*, 263: 17-27 (2004).
- [8] Inal, A. Gunes, F. Zhang, and I. Cakmak, “Peanut/maize intercropping induced changes in rhizosphere and nutrient concentrations in shoots”. *Plant Physiology and Biochemistry*, 45: 350-356 (2007).
- [9] G.J. Bethlenfalvai, M.G. Reyes-Solis, S.B. Camel, and R. Eerrera-Cerrato, “Nutrient transfer between the root zones of soybean and maize plants connected by a common mycorrhizal mycelium”. *Physiologia Plantarum*, 82: 423-432 (1991).
- [10] Hamel, C. Nesser, U. Barrantes-Cartin, and D.L. Smith, “Endomycorrhizal fungal species mediate 15N transfer from soybean to maize in non-fumigated soil”. *Plant and Soil*, 138: 41-47 (1991).

- [11] W. Wangiyana and I.G.M. Kusnarta, "Peningkatan Serapan N dan Hasil Tanaman Jagung Varietas Lokal Bima melalui Tumpangsari dengan Beberapa Jenis Tanaman Legum". *J. Penelitian Univ. Mataram*, 14(1): 41-49 (1998).

Improving Growth and Bulb Production of Several Varieties of Shallot through Mycorrhiza Inoculation and Growing Peanut Plants Inserted between Double-Rows of Shallot (*Allium ascalonicum* L.)

Wayan Wangiyana^{1*}, I Komang Damar Jaya¹, I Gde Ekaputra Gunartha¹,
Sunarpi²

¹Faculty of Agriculture, University of Mataram, Mataram, Lombok, Indonesia

² Faculty of Mathematics and Natural Science, University of Mataram, Mataram, Lombok, Indonesia

* Email: w.wangiyana@unram.ac.id

Abstract

This study aimed to examine the effects of inoculation of arbuscular mycorrhizal fungi (AMF) propagules and growing peanut plants inserted between double-rows of shallot on growth and bulb production of several shallot varieties, by conducting a field experiment in Narmada (West Lombok, Indonesia), from June to September 2016. The experiment was designed according to Split Split-Plot Design, testing three treatment factors, i.e. additive intercropping of peanut (P) between double-rows of shallot as the main plot factor (P0= without, P1= with intercropping), AMF inoculation (M) as the sub-plot factor (M0= without, M1= with AMF inoculation), and shallot varieties (V) as the sub-sub-plot factor (V1= Ampenan, V2= Bima Brebes, V3= Ketamonca, V4= Super Phillip varieties). Results indicated that among the three treatment factors, it is most likely that genotypic differences between varieties were the most significant factor affecting differences in growth and bulb production of those shallot varieties, in which Ketamonca and Super Phillip showed better performance than the other varieties, and Ampenan variety showed the lowest growth and bulb production. Application of AMF propagules resulted in significantly higher growth, especially in leaf number, and bulb production, whereas additive intercropping with peanut by inserting a row of peanut plants between double-rows of shallot did not show significant effects but there was a tendency that intercropping resulted in better growth of shallot during the vegetative growth of the peanut plants, especially for shallot inoculated with AMF. However, the three treatment factors did not show significant interaction effects on all observation variables.

Keywords: *double-rows, intercropping, mycorrhiza, peanut, shallot*

1. Introduction

Shallot (*Allium ascalonicum* L.) is a group of vegetable crops highly important in Indonesia especially as spices in everyday cooking ingredients. Shallot has also been used as a medicine since ancient times, and its red color is caused by anthocyanins contained in the bulbs [1,2]. Not only in Indonesia shallot is also a very important crop in the world, especially in tropical areas of the world, where shallots are mostly produced and consumed [3]. However, in Indonesia shallot productivity achieved by the farmers is on average still relatively very low, with the highest average of 13.04 ton/ha in Bali province in 2014 [4]. According to Currah [3], shallot productivity reached an average of 47.6 ton/ha in the United States and 58.0 tons/ha in Korea, while in the same year, it was only 10.1 ton/ha in Indonesia. Therefore, better production technologies need to be found to improve shallot productivity, especially in Indonesia.

According to the results of several studies abroad, shallots are very responsive and can

even be categorized as highly dependent on symbiosis with arbuscular mycorrhizal fungi (AMF). Charron *et al.* [5,6] reported that AMF preinoculated shallot seedlings enlarged the bulbs faster to achieve marketable sizes (2-3 weeks faster) compared with other inoculation treatments whereas those without AMF inoculation remained stunted. Powell *et al.* [7] also reported different responses between shallot cultivars to AMF inoculation treatments. However, so far there has been no information on the responses of Indonesia shallot varieties to AMF, especially in the West Nusa Tenggara (NTB) province. This study aimed to examine the response of some shallot varieties to AMF inoculation and additive intercropping with peanut plants that are inserted between double-rows of shallots.

2. Materials and Methods

The field experiment, conducted in an entisol paddy field located in the experimental farm in Narmada (West Lombok, Indonesia), from June to September 2016, was arranged according to the Split Split-Plot design, testing three treatment factors, namely: additive intercropping of shallots with peanut (T) as the main plot factor (T0 = without intercropping, T1 = intercropped with peanuts); inoculation of shallot with AMF propagules (M) as the subplot factor (M0= without inoculation, M1= inoculation with AMF); shallot varieties (V) as the sub-subplot factor (V1= Ampenan, V2= Bima Brebes, V3= Ketamonca, and V4= Super Philip varieties). Each treatment combination was made in 3 blocks.

For planting preparation, after cultivating the rice field with once plowing and once harrowing, raised beds for planting shallot were created, with a size of 1.20 m x 0.75 m separated by a surrounding furrow of 25 cm width and 20 cm depth. One day before planting, the tip of the seed-bulbs were cut, then planted the following day on the raised beds using a basic spacing of 20 cm x 15 cm, but because double-rows of shallot were required, then the 20 cm between-row was modified to make 15 cm within a double-row and 25 cm between double-rows in which a row of peanut plants was inserted with 15 cm within-row spacing to establish an additive intercropping system. Both edges of the beds were also planted with one row of peanuts each. Peanut was planted three days after planting shallot seed-bulbs.

Shallot fertilization was done with "Bokashi" (EM-4 fermented compost of cattle manure) of 50 g/clump (17 ton/ha), Phonska (15% N, 15% P₂O₅, 15% K₂O, 9% S) of 2.1 g/clump (700 kg/ha), and ZA (21% N, 24% S) of 0.9 g/clump (300 kg/ha), while peanut was basalt fertilized with Phonska of 1.2 g/plant (200 kg/ha). The Bokashi compost was applied at planting in the shallot planting hole below the seed-bulb. For shallot inoculated with AMF, the inoculant was placed below the Bokashi in each shallot planting hole, with a dose of one table spoon full. Phonska for shallots and peanut was applied 7 days after planting (DAP) shallot, by dibbling Phonska into a hole of 7 cm depth and 7 cm next to the young plants. ZA for shallot was applied at 30 DAP with the same way of applying Phonska.

Watering was done by flowing water through the furrows surrounding the raised beds when the beds were dry but watering was rarely needed because there were sufficient rains during the experiment. Weeds were controlled by removing them, while pests (caterpillars) were controlled with alternating sprays of the insecticides Decis 25 EC and Amcothene 75 SP with an interval of 5 days during the attack. Shallot bulbs were harvested at the age of 65 DAP.

Observations were made on the growth variables (plant height, leaf number, and tiller number, measured every 7 days), and the formation of onion bulbs. Data were analyzed by analysis of variance (ANOVA) and Honestly Significant Difference (HSD) test at 5% level of significance, using the statistical software CoStat for Windows. The average growth rates (AGR) were measured using slope coefficient of regression between age of the plants and the

growth variables.

3. Results and Discussion

Based on the ANOVA results, the differences between shallot varieties tested almost all significant in relation to the observation variables except the average growth rate (AGR) of leaf number and tiller number. In contrast, intercropping with peanut showed significant effects only on leaf number at 3 and 4 WAP, while AMF inoculation significantly affected AGR of plant height and leaf number, and leaf number (at 3, 4, 5, 6 and 7 WAP), and bulb number per clump. However, the interaction effects between the treatment factors are generally not significant on almost all observation variables except between AMF inoculation and intercropping (MxT) on AGR of plant height and leaf number at 5 WAP, and interaction between varieties of shallot and AMF inoculation (VxM) on AGR of leaf number (Table 1).

Table 1. Summary of ANOVA results on average growth rate (AGR) of plant height, leaf number, and tiller number, and plant height at 7 WAP, leaf number at 3, 4, 5, 6 and 7 WAP, tiller number at 6 and 7 WAP, and bulb number per hill

Observation variables	Main effects			Interaction effects			
	T	M	V	MxT	VxT	VxM	VxMxT
AGR of plant height	ns	**	***	*	ns	ns	ns
AGR of leaf number	ns	**	ns	ns	ns	*	ns
AGR of tiller number	ns	ns	ns	ns	ns	ns	ns
Plant height 7 WAP	ns	ns	***	ns	ns	ns	ns
Leaf number 3 WAP	*	**	***	ns	ns	ns	ns
Leaf number 4 WAP	**	***	***	ns	ns	ns	ns
Leaf number 5 WAP	ns	***	***	*	ns	ns	ns
Leaf number 6 WAP	ns	**	***	ns	ns	ns	ns
Leaf number 7 WAP	ns	*	*	ns	ns	ns	ns
Tiller number 6 WAP	ns	ns	***	ns	ns	ns	ns
Tiller number 7 WAP	ns	ns	***	ns	ns	ns	ns
Bulb number per clump	ns	**	***	ns	ns	ns	ns

Remarks: AGR = average growth rate; T = intercropping, M = mycorrhiza, V = varieties; ns = non-significant; *, **, *** = significant at $p < 0.05$, $p < 0.01$, and $p < 0.001$, respectively

On the MxT interactions, there are slightly different effects of AMF inoculation between intercropping and shallot monocrop. For AGR of plant height, the effects of AMF inoculation was not significant in monocrop shallot but AMF was highly significant in increasing plant height AGR, and without AMF, intercropping was significantly decrease the AGR, compared with monocrop (Fig. 1A). On leaf number of shallot at 5 WAP, however, it seems that there was no effects of intercropping but the significant increasing effects of AMF were higher in the peanut intercropped shallot than the monocrop (Fig. 1B). In contrast, although the interaction effect was not significant, the average number of shallot green leaves was higher in those intercropped with peanut than on the monocrop when shallot was not inoculated with AMF (Fig. 1C), indicating contributing effects of intercropping with peanut on number of shallot leaves that are still green approaching to its maturity at 60 DAP. This could be due to some transfer of nitrogen from the rhizosphere of peanut to roots of shallots because peanut plants are capable of fixing atmospheric nitrogen, and many researchers have

reported this kind of N transfer, such as reported by Fujita *et al.* [8] from soybean to sorghum, Chu *et al.* [9] from peanut to rice, and Inal *et al.* [10] from peanut to maize in an intercropping. However, intercropping or AMF inoculation seems to have similar effects on bulb number (Fig. 1D), in which the magnitude of the significant effects AMF inoculation were similar between intercropping and monocrop treatments on bulb number.

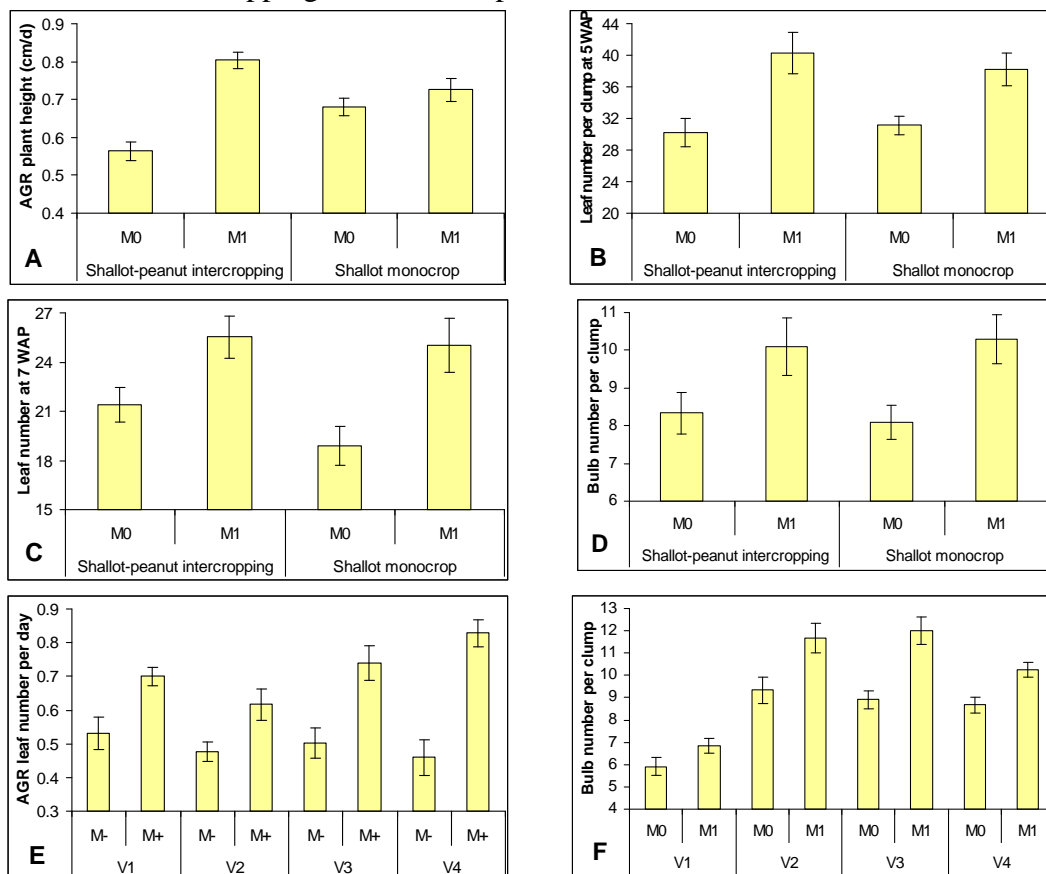

Figure 5. The effects of AMF inoculation between intercropping and monocrop treatments on AGR of plant height (A), leaf number at 5 WAP (B), leaf number at 7 WAP (C), and bulb number per clump (D), and the effects of AMF inoculation among the varieties of shallot tested on AGR of leaf number and bulb number, based on the average (Mean \pm SE) values.

In terms of interaction effects between varieties of shallot and AMF inoculation, there were differences in the response of varieties to AMF inoculation in terms of AGR of leaf number (Fig. 1E), in which among the varieties tested, V4 (Super Philip) showed the highest response and V2 (Bima Brebes) showed the lowest response to AMF inoculation. Although there was no interaction effects, the magnitudes of increasing effects of AMF inoculation on bulb numbers were also different among the varieties tested (Fig. 1F), again indicating different responses of those shallot varieties to AMF. Nevertheless, what is significant is that AMF inoculation significantly improved growth and bulb number yielded by all shallot varieties tested. Similar results were also reported by Powell *et al.* [7], in which different varieties tested showed different levels of AMF infectivity. Charron *et al.* [5,6] also reported that onion seedlings preinoculated with AMF grew faster than other

techniques of inoculation while the uninoculated onions remained stunted.

4. Conclusion

Based on the results it can be concluded that all varieties of shallot commonly grown in the West Nusa Tenggara (NTB) areas, including Ampenan, Bima Brebes, Ketamonca, and Super Philip varieties, are highly responsive to AMF inoculation. Therefore, it is necessary to find out best isolates of indigenous AMF of agricultural lands from various locations in NTB, especially from various location of shallot growing centers, followed by some multi-location research, in order to formulate AMF technology to improve shallot productivity in NTB.

Acknowledgement

Through this article the authors would like to thank the Rector of the University of Mataram for funding this research project through the “PNBP” Research Grant, with the Contract Agreement, No. **168A/SP-BLU/UN18.12.2/PL/2016**.

References

- [1] M. Keusgen, “Health and *Alliums*”. In: H.D. Rabinowitch and L. Currah (Eds), *Allium Crop Science: Recent Advances*. CAB International: New York, USA: 357-378 (2002).
- [2] J.L. Brewster, *Onions and Other Vegetable Alliums*, 2nd Edition. CABI, Wallingford, UK, 2004.
- [3] L. Currah, “Onions in the Tropics: Cultivars and Country Reports”. In: H.D. Rabinowitch and L. Currah (Eds), *Allium Crop Science: Recent Advances*. CAB International: New York, USA: 379-407.
- [4] BPS, *Statistik Tanaman Pangan*, 2016. Biro Pusat Statistik, Indonesia. <http://www.bps.go.id>.
- [5] G. Charron, V. Furlan, M. Bernier-Cardon, and G. Doyon, “Response of onion plants to arbuscular mycorrhizae: 1. Effects of inoculation method and phosphorus fertilization on biomass and bulb firmness”. *Mycorrhiza*, 11: 187-197 (2001).
- [6] G. Charron, V. Furlan, M. Bernier-Cardon, and G. Doyon, “Response of onion plants to arbuscular mycorrhizae: 2. Effects of nitrogen fertilization on biomass and bulb firmness”. *Mycorrhiza*, 11: 145-150 (2001).
- [7] C.L. Powell, G.E. Clark, and N.J. Verberne, “Growth response of four onion cultivars to several isolates of VA mycorrhizal fungi”. *New Zealand Journal of Agricultural Research*, 25: 465-470 (1982).
- [8] K. Fujita, S. Ogata, K. Matsumoto, T. Masuda, G.K. Ofosu-Budu, and K. Kuwata, “Nitrogen Transfer and Dry Matter Production in Soybean and Sorghum Mixed Cropping System at Different Population Density”. *Soil Sci. Plant Nutr.*, 36(2): 233-241 (1990).
- [9] G.X. Chu, Q.R. Shen, and J.L. Cao, “Nitrogen fixation and N transfer from peanut to rice cultivated in aerobic soil in an intercropping system and its effect on soil N fertility”. *Plant and Soil*, 263: 17-27 (2004).
- [10] A. Inal, A. Gunes, F. Zhang, and I. Cakmak, “Peanut/maize intercropping induced changes in rhizosphere and nutrient concentrations in shoots”. *Plant Physiology and Biochemistry*, 45: 350-356 (2007).

Skill of *Warige* as A Seasonal Climate Forecast in Lombok, Indonesia

Ismail Yasin^{1*}, Mahrup¹, Mansur Ma'shum¹, Sukartono¹, Husni Idris²

¹Faculty of Agriculture University of Mataram, Jalan Majapahit Mataram 83125, E-mail:

²Program of Forestry University of Mataram, Jalan Pemuda Mataram 83125

*puslisda@gmail.com

Abstract

Seasonal climate variability has a pronounced effect on the agricultural sector in Lombok. A seasonal climate forecast model based on indigenous knowledge was implemented and tested its forecast skill. The seasonal climate forecast implements the day of “*tumbuk*” (overhead sun) in Lombok (8.5° S) which is associated with moon phases. If overhead sun corresponds to crescent (6th), it is predicted to have above normal rainfall for in coming season. If overhead sun is on a full moon phase (16th), it is predicted to have normal (average) rainfall, and when overhead sun falls on last quarter or waning phase (26th), rainfall tend to be below normal or dryer than average. The data used were a 60 year monthly rainfall data over Lombok Island. Java Calendar available at <http://kalenderjawa.com> was applied to find out moon phase at overhead sun since year 1950. Verification of forecast using 60 year monthly rainfall data in Lombok shows a significant differences of seasonal rainfall of wet years compared to dry year. Forecast skill Analysis using LEPS method shows skill score ranged from 3,6 to 24.meaning that forecasting capability of *Warige* quite accurate for Lombok Island's rainfall. It is strongly recommended exploring the possibility of basic principle of *Warige* to be applied in broad areas of Indonesia which have similar geographical condition with the original area of *Warige* in Lombok.

Keywords: *Seasonal climate variability, Seasonal climate forecast, Warige Tumbuk, overhead sun, Sasak calendar, moon phase., forecast skill, LEPS*

1. Introduction

Sasak ethnic in Lombok is well known as a community with rich of culture and tradition. They live in erratic seasonal rainfall, hence most farmers were dependent on dry land or rainfed farm system. Ancient agriculture of Sasak community was carried out under strict rule of conduct in getting harmony with nature (Mahrup et al., 2009, Yasin et al., 2013).

Changes in civilization along with implementation of green revolution have made people mind more pragmatic. Farmers changed from subsistence practices to more commercial agriculture. Current practice of agriculture is highly dependant on external inputs such as fertilizers and pesticides. Progress in irrigation made them no longer dependent on old practices such as use of *Warige* for seasonal climate forecast. meanwhile extreme weather event such as excessive rain during dry season frequently causes crop failure due to flood. It is evidently a strong cause of tobacco plant failure in Vertisols Lombok (Yasin et al., 2011; Yasin, 2015).

Traditionally Sasak Ethnic of Lombok believes that the cause of seasonal rainfall variability is due to interaction of celestial bodies in the sky i.e. position of sun and moon relative to the earth. Sasak community believed that change in moon position relative to the sun may promote or hinder rain event (Mahrup et al., 2009). Establishment of “*tumbuk*” (overhead sun) date which is associated with moon phase is the way of Sasak community determining the onset of rainy season. In wet year (overhead sun date associated with crescent) the onset of

rainy season is on mid November followed with heavy rainfall on December. In dry year (overhead sun date associated with waning) the onset of rainy season is on early to mid December followed with sporadic rainfall on the following months. Nevertheless the characteristics of seasonal or annual rainfall is not simply following the rule. It may vary from year to year and from place to place. Therefore the objective of this research is to examine the skill of *Warige* in forecasting seasonal rainfall characteristics in Lombok Indonesia.

2. Materials and Methods

2.1 Location and Data Requirement

The study was conducted in the center of tobacco plantation in southern part of Rinjani mountains Lombok Island. Data required include daily and monthly rainfall taken from selected rainfall gauge within study location. The data belong to BMKG stations and BISDA NTB. Rain gauges selected were Gerung, Mantang Jonggat, Pringgarata, Janapria, Penujak, Pujut, Terare, Sikur, and Jerowaru.

2.2. Determination Overhead sun and Moon Phase

The most critical stage in *Warige* system is determination of overhead sun and moon phase which is coincidence at the time of *tumbuk* (Overhead sun). Overhead sun in Lombok occurs on every October 15th.in Lombok which is in 8,5^oS. The date is associated with lunar phase at the time. When lunar phase is crescent (about date of 1st to 10th of lunar calendar), it is predicted that the rain will be heavy during December, January and February (DJF). When lunar phase is full moon (11th to 20th) it is predicted to have normal rain during those months, and when lunar phase is Waning moon (21th 29th or 30th) it is predicted to have less rainfall during DJF months..We used Java Calendar <http://kalenderjawa.com>.to find out moon phase at the date of overhead sun from year 1950 to current year (2015).

2.3. Forecast Skill Analysis

Prediction skill of *Warige* was tested by using LEPS (Linear Error in Probability Space) method (Pott et al., 1996). We used indices -3 for dry, 0 for moderate and +3 for wet. For individual forecast, if the position of cumulative distribution of forecast is P_f (value range from 0,0 s/d 1,0), and cumulative distribution of observation is P_o , then LEPS score is formulated as follows:

$$S = 3(1 - |P_f - P_o| + P_{f2} - P_f + P_{o2} - P_o) - 1 \quad (1)$$

From above equation can be seen that probability of P_o is given maximum skill score (1) when $P_f = P_o$. Besides, the nearest skill with “true” forecast at extreme of cumulative distribution is given score almost 2. “True” forecast in the middle of cumulative distribution ($P_o = 0,5$), is given small score (around 0,5). The worse score that probably happen is -1.0 which is reverse of forecast value of extreme occurrence at an extreme observation. (such as, $P_o = 0,0$ and $P_f = 1,0$).(Ward and Folland, 1991).

To have total score of whole skill, it is given a set or ensemble of forecast. Skill score from 100% to -100%, Average skill (SK) is formulated as follows (Potts *et al.*, 1996.):

$$SK = \frac{\sum 100S}{\sum S_m} \quad (2)$$

LEPS measures forecast error as “distant” in probability of cumulative distribution selected.(frequently happens from verification of observation) between forecast and proper observation. If error in forecast is the same as observation error, the LEPS score will be zero

(Frederiksen *et al.*, 2000).

3. Results And Discussion

3.1 Pattern of Wet and Dry Years

Based on moon phase on the day of overhead sun the wetness year changes with regular pattern. For example, from November 1999/2000 to October 2015 the pattern of rainfall during rainy season was WMD WMD, MD, WMD, WMD, MD, WMD, where W is wet, M is moderate and, D is dry.. In dry season the pattern would be DMW DMW, MW, DMW DMW, MW, DMW.

Every wet year (rainy season with high rainfall) will be followed with dryer condition of dry season. However the wetness or the dryness of every season never the same with previous wet or dry year. Each year has different amount of rainfall. This differences are caused by different date of overhead sun. For example in case of wet year (overhead sun associated with crescent (date 1st to date 10th). When overhead sun fall near date 1st rainfall tend to have dry year characteristics; meanwhile when overhead sun fall near date 10th rainfall tend to have moderate year characteristics, vice versa.

Moon phase on the date of overhead sun is evidently related to the shift of convective rainfall occurrence. If overhead sun occurs on crescent, the moon is in southern hemisphere and it will be in northern hemisphere when the sun reach 20^oS in mid December..The period of dry spell corresponds to the presence of moon in southern hemisphere in its synodic cycle. This can be explained by using a luni-solar calendar (Mahrup *et al.*, 2008). When overhead sun (15 October) associated with waning the moon is south hemisphere in its synodic cycle when the sun reach 20^oS. This will hinder rain occurrence (dry spell) during the time. According to Mahrup *et al.* (2008) and Yasin *et al.* (2011) the cause of wet and dry spell is gravity forces between sun and earth and between earth and moon. In full moon the moon directly face the earth resulting in high tide (Bradley, *et al.*, 1962; Brier et al, 1965;). Due to a resultant of gravity forces (sun and moon) exerted on the earth is so great, then spring tide is performed when the sun, moon and earth are in a straight line. Similar events occur during the full moon phase, in which the sun, earth and moon are in a straight line for second time. On the first quarter and the last quarter caused Lowest tides (neap tides) (Brier and Bradley, 1964);. Spring tide has a great effect on dynamics of sea water which is the origin of atmospheric water vapor nearby (Serway, 1990). Gravity from the moon is directly transferred to the mass of water directly perpendicular to the position of the moon. If full moon and new moon phase take place in the southern hemisphere, then the effects of gravity will be experienced by a water body in the southern hemisphere, and vice versa (Mahrup et al., 2008).

At period of overhead sun the sun rays make a right angle in Lombok. The sun goes southward and gives its heat energy onto Indian Ocean (Linacre and Geerts, 1982). It results in increasing evaporation rate in the ocean, increasing sea surface temperature and relative humidity of atmosphere. Snellius Law explains that incoming radiation which is on right angle onto a flat plane (earth surface) produces the highest intensity (Serway, 1990). Energy of sun reaches the earth surface is constant of about 1,367 watt/m², or 3.67x 10²¹ cal per per day with *albedo* of about 30% (Linacre and Hobbs, 1977,). Temporal and spatial variation of the energy from the sun on earth surface depends on the position of the earth on its orbit (Tjasyono, 2007).

3.2. Forecast Skill of Warige

The result of LEPS test showed that skill level of rainfall forecasting based on *Warige* ranged from moderate to strong. Nevertheless, it is quite obvious that skill distinguishes

between rainfall types in wet and dry years. Analysis of *Warige* skill by LEPS method of climate forecast *Warige* showed a significantly different between rainfall in wet and dry years with skill ranged from 0.49 to 8.10 for rainy season and from 3.6 to 24 in dry season at several locations in the southern part of Mount Rinjani Lombok . (Table 1) .

Table 1. Prediction of Rainfall and Skill Analysis for Warige in Southern Lombok

Location	Type Climate	Wet Season (NDJFM)			Skill LEPS	Dry Season (MAMJ)			Skill LEPS
		Dry	Normal	Wet		Dray	Normal	Wet	
Gerung	D4	745	872	793	0,49	387	389	427	24,8
Mantang	C3	1394	1664	1630	3,10	605	645	715	7,80
Jonggat	D3	1148	1273	1344	8,10	659	519	669	6,40
Pringgarata	D3	1044	1029	1059	10,8	500	450	571	6,90
Pujut	D4	1125	1197	1297	1,90	357	304	378	5,00
Penujak	D3	1079	1089	1170	11,0	316	341	439	3,60
Janapria	D4	1244	1074	1061	0,50	500	450	571	6,90
Terare	D4	1169	1098	1239	5,24	360	295	366	6,80
Sikur	D3	1095	962	1106	2,78	402	422	465	5,90
Jerowaru	E4	986	877	988	2,00	131	183	221	14,4

A positive number of LEPS indicates the level of consistency between the predictor (*Warige*) with predictand (forecasting output). When the value of LEPS is 0 means that forecasting result is similar to real data observation of average value. If the value is negative, meaning that forecasting results is worse than average. When a large positive value of LEPS indicate that prediction results are very consistent with real data observation (better than average value)..

4. Conclusion

Warige is a model for seasonal climate forecast which is based on celestial bodies observation. The principal method of *Warige* is observation of the date of overhead sun or “tumbuk” then associates it with moon phase at the date. If overhead sun correspond to crescent (6th), then rainfall in coming growing season (DJF) will be above normal or wet season. If the over head sun falls on the full moon phase (16th), the rainfall in growing season will be normal (moderate), and when overhead sun coincides with waning moon (26th), the growing season will be slightly dry (not drought) Verification of forecast using 50 year monthly rainfall data in Lombok shows a significant differences of seasonal rainfall of wet years compared to dry year. Forecast skill Analysis using LEPS method shows skill score ranged from 0.49 to 8.10 for rainy season, and 3,6 to 24.for dry season, meaning that forecasting capability of *Warige* quite accurate, mainly during dry season for Lombok Island’s rainfall. It is strongly recommended exploring possibility of basic principle of *Warige* to be applied in broad areas of Indonesia which have similar geographical condition with the original area of *Warige* in Lombok.

References

- [1] Bradley, D.A., M.A. Woodbury and G.W. Brier. 1962. Lunar synodic period and widespread precipitation. *Sci.*, 137: 748-749

- [2] Brier, G.W and D.A Bradley. 1964. The lunar synodical period and precipitation in the United States. *J.Atmos. Sci.* 21: 386-395
- [3] Linacer, E. Hobbs, J., 1977. The Australian climate environment. John Wiley and Sons. Brisbane. 354p.
- [4] Linacre, E. & Geerts, B. (1982). Rainfall, temperature and lunar phase. <http://www-das.uwyo.edu/~geerts/cwx/notes/chap10/moon.html>
- [5] Mahrup, I. Yasin, H. Idris. 2008. Verifikasi model *Warige* dengan southern oscillation index dalam prakiraan sifat iklim: . pp. 211-216. Proceeding of the National Seminar for the 41st Dies Natalis of The Faculty of Agriculture, Mataram University on 23 - 24 February 2008.
- [6] Mahrup, I. Yasin, H. Idris. 2009. Revitalisasi model *Warige* dengan Southern Oscillation Index dalam prakiraan sifat iklim: Suatu kajian ilmiah terhadap kearifan lokal suku Sasak di pulau Lombok.. . pp. 211-216. Proceeding of the National Seminar for the 41st Dies Natalis of The Faculty of Agriculture, Mataram University on 23 - 24 February 2008
- [7] Potts J. M., C. K. Folland, I. T. Jolliffe, dan D. Sexton, 1996: Revised “LEPS” scores for assessing climate model simulations and long-range forecasts. *J. Climate*, **9**, 34–53. [available online](#)
- [8] Serway, R.A., *Physics for scientists and engineers*. Third Edition. Saunders College Publishing. Philadelphia. 1321p.
- [9] Tjasyono, B., 2007. *Meteorologi Indonesia I: Karakteristik dan Sirkulasi Atmosfer*. Badan Meteorologi dan Geofisika. Bandung. 191p.
- [10] Yasin I. 2013. *Kompilasi Sistem Prakiraan Iklim Musiman Berbasis Kearifan Lokal dengan Indikator Fenomena ENSO Sebagai Alat Bantu Pengambilan Keputusan Tanam Padi-Tembakau dan Palawija di Pulau Lombok*. Laporan Hibah Disertasi.
- [11] Yasin I. 2015. *Adaptasi Budidaya Tanaman Semusim Akibat Perubahan Iklim: Pengembangan Model Prakiraan Iklim Musiman Berbasis Kearifan Lokal dan Fenomena ENOS di Pulau Lombok*. Disertasi PPsFP UB. Malang (unpublished)
- [12] Yasin, I., Idris, H. & Mahrup. (2011). *Kompilasi sistem Warige dengan Southern Occillation Index (SOI) dan Sea Surfase Temperature (SST) sebagai model prakiraan iklim lokal di Nusa Tenggara Barat*. 187 p. Laporan penelitian Ristek (unpublished).

Simple Solar Desalination for Seawater at Kec. Bayan Kab. Lombok Utara

Dhony Hermanto^{*)}, Nurul Ismillayli, Siti Raudhatul Kamali, Fahrurazi

Department of Chemistry, Faculty of MIPA – University of Mataram, Mataram

**)Email: dhony.hermanto@gmail.com*

Abstract

The water crisis is one of main problems that routinely occur in Kabupaten Lombok Utara, especially Kecamatan Bayan. Due to its characteristics i.e. limited availability of water, poor soil fertility, poor both economically and level of education sanitation and communities, production of clean water by using simple, effective and affordable technology are needed. The socialization and counseling followed by practicing on production of low cost solar desalination device that easy to maintain. The process included setting and optimizing of device desalination, physical, chemical and microbiological properties determination of both seawater and fresh water, socialization and production workshop of desalinator to some farmer groups of Kec. Bayan. Result showed that produced water is low mineral water that safe and drinkable due to its standards meet Drinking Water Quality Requirements based on Peraturan Menteri Kesehatan Republik Indonesia Number 492/Menkes/PER/IV/2010 at April 19, 2010. Product of this activity is expected to be an alternative solution to overcome water crisis despite still needed some refinement for increasing its productivity.

Keywords: *desalination, fresh water, seawater, solar energy.*

1 Introduction

Clean water is essential to human life and is a critical feedstock in a variety of key industries including electronics, pharmaceuticals and food [1][2]. All humans daily consume water to sustain life and maintain a good health, therefore water conservation is important and its quality must meet specific standards. The quality of water is determined by many factors such as physical, chemical or biological parameters.

The world is facing formidable challenges in meeting rising demands of clean water as the available supplies of freshwater are decreasing due to (i) extended droughts, (ii) population growth, (iii) more stringent health-based regulations, and (iv) competing demands from a variety of users. It has been reported that lack of access to clean water was routinely occur in Kabupaten Lombok Utara, especially Kecamatan Bayan [3]. People use nearby water springs that flowed by using a small pipe or hose for clean water pipelines built unevenly local government. While people who live far from water sources should be drilled to a depth of 100 meters or walk up to 3 km more to get clean water [4]. Geographically, most of KLU is coastal region, while there is an abundance of seawater, it cannot be used for daily activities such as agriculture and consumption. The sea water contains high levels of salt from 3 to 4.5% [5] and TDS (Total Dissolve Solid) high that cannot be used directly . There is a need for a way to desalinate seawater that is both effective and affordable.

There are many ways to desalinate water. Two examples are reverse osmosis and the use of pressure to drive water through a filter[6]. These methods are good for producing a large amount of fresh water but systems consume a lot of fuel, electricity or filters in operation. Those systems are not suitable for Bayan society because of the high running cost. Solar desalination is the most effective method that suits the target society's needs[7]. The sun's radiation evaporates the water leaving only salt behind. Once evaporated, the water recondenses and collects into a specific storage container then condensed water is free of salt

and safe to drink. In this study developing a simple solar desalination for producing fresh water using low cost and easy to maintain device was done. Its result then publish by socialization and production workshop of desalination device to some farmer groups of Kec. Bayan.

2 Material and Method

Desalination device consist of three main components i.e. container of sea water, cover device and freshwater reservoir. The materials need to be corrosion resistant, light weight, and durable enough to withstand daily use over an extended period of time. The final design should be small enough to be carried and set up by one person with no oversight. The material are aluminum, glass, wood, nail, glass and silicon red adhesive. The activities carried out with several stage : 1) design optimization and desalination device testing, 2) condensat water quality testing by using standart method, 3) socialization and production workshop of desalination device.

This program was done with two partners, namely the farmer groups "SPB 212" and UPTD Department of Agriculture Plantation Forestry Maritime Affairs and Fisheries (DPPKKP) Bayan district. Farmer groups as user of device while UPTD Department of Agriculture Plantation Forestry Maritime Affairs and Fisheries (DPPKKP) of Kec. Bayan acts as a liaison between the extension with farmer groups in Kec. Bayan and helps to utilize and disseminate the results program.

3. Result and Discussion

3.1 Design Optimization and Desalination Device Testing

Aluminum as containers seawater was chosen because it's good heat conductivity properties and resistant to corrosion by seawater (obtained from the formation of aluminum oxide, Al_2O_3 on aluminum surface). Glass was chosen as the cover device to catch the water vapor and condense it. The glass used has thickness of 3 mm, thicker glass will store enough heat so that condensation is slower. When the desalination apparatus exposed to the sun, solar radiation entering through the cover glass toward the sea water in container. Good heat conductivity of aluminum container causes the temperature of glass, room and sea water increase due to increasing intensity of the sun. Temperature inside of device is greater than environment temperature . It is caused by transmited and trapped heat inside of it. The higher temperature of sea water, the faster movement of molecules, hence it will lead to more rapid mass transfer process from a liquid to a vapour phase. The sea water in the container evaporates and attaches to inner glass cover. Condensing process is influenced by the temperature of glass cover chamber. Condensate water could be seen sliding down the glass into canal and flowing to collection bottle. The prototype device consist of 2 models with different slope. First prototype (A) has a pyramidal geometry with slope of 56° and the second prototype (B) has a triangular prism geometry with slope of 30° , as shown in Fig. 1 below

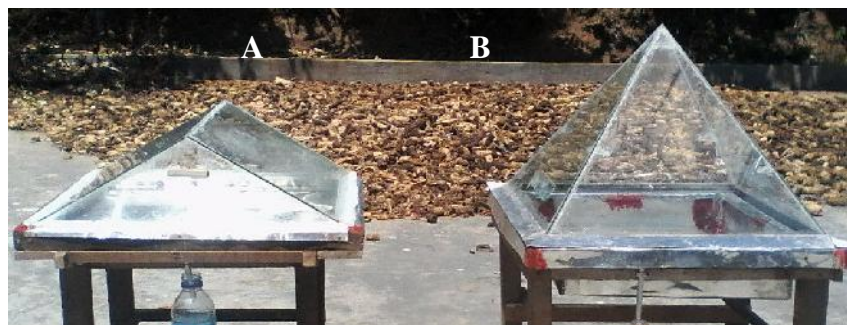

Figure 1. (A) Prototype pyramid geometry and (B) Prototype triangular prism geometry

The prototype testing carried out for 7 days in Bayan village by heating under the sun together since 09.00 am until 06.00 pm. The water level in the container effect the evaporation, the more water in the container, the longer water evaporation occure. However, the lack of water will cause overheating then cracking of cover glass. Additionally, the desalination device must be tight so that leakage of water vapor can be minimized. Geometry and slope of cover glass, rate of evaporation and condensation affect the volume of condensate obtained, as shown in Table 1. The evaporation is better when the temperature of sea water in the aluminum container is higher. While, faster condensation occurs when the temperature of cover glass is cooling down. This is indicated by the rapid condensation when the late afternoon. Based on Table 1, it can be seen that the higher intensity of solar radiation, the higher environment temperature and the more water condensation occur.

Table 1 Test result of prototypes

Type Prototype	Size characteristics	Tests on day							
		Parameter	1	2	3	4	5	6	7
Prototype A	p= 46,5 cm = 46,5 cm t= 13,5 cm = 30°	Temp. (°C)	27-32	26-31	27-32	28-32	28-32	28-32	28-32
		Condensate Vol.(mL)	458	428	448	465	467	469	470
Prototype B	p= 46,5 cm = 46,5 cm t= 34 cm = 56°	Temp. (°C)	27-32	26-31	27-32	28-32	28-32	28-32	28-32
		Condensate Vol.(mL)	390	350	387	410	407	420	428

3.2 Condensate Water Quality Testing

Results of laboratory analysis of the water quality of the sea water and condensate as shown in Table 2. All parameters has value below the maximum levels allowed and categorize as low minerals water.

Table 2 Water quality parameters tested

Tested Parameter	Value		
	Sea water	Condensate ^a	max.value allowed ^b
Physical Parameter			
Smell	odorless	odorless	odorless
flavor	Salty	tasteless	tasteless
TDS	61,5 mg/L	0	500 mg/L
Temperature	27 °C	27 °C	Air temp. ±3°C
Chemical Parameter			
Fluorida	1,3 mg/L	0 mg/L	1,5 mg/L
Aluminum	0,01 mg/L	0 mg/L	0,2 mg/L
Iron	0.002 mg/L	0 mg/L	0,3 mg/L
sulphate	5.680 mg/L	0 mg/L	250 mg/L
Nitrite	4 mg/L	0 mg/L	3 mg/L
Hardness	1.380 mg/L	0 mg/L	500 mg/L
Chloride	19.000	0 mg/L	250 mg/L
pH	7,3	7	6,5-8,5
Sodium	10.300 mg/L	0 mg/L	200 mg/L
Microbiological Parameter			
E. Coli.	-	0	0 /100 mL analyte
Total coliform	-	0	0 /100 mL analyte

a.The test results in the laboratory of Chemistry and Analytical Chemistry, University of Mataram

b.Regulation of the Minister of Health of the Republic of Indonesia No. 492/Menkes/PER/IV/2010 on

3.3 Socialization And Production Workshop Of Desalination Device

Socialization activities carried out by inviting some representatives of farmer groups in Bayan and several local community leaders. Basic principle of desalination device and how to make it by utilizing available and affordable was presented in the socialization. The method used is followed by a lecture and discussion / question and answer session to determine the extent of exposure of the participants in receiving the material. This activity was continued with production workshop of device, as in Fig. 2.



Figure 2 Socialization activities IBM Based Solar Desalination in Kec. Bayan, KLU

Positive response on this transfer technology was shown by participants. They expect this appropriate technology can be an alternative solution to overcome the water crisis in their area.

4. Conclusion

It has created desalination device for seawater based on solar power by using low cost, durable materials and easy to maintain. Based on the test parameters of physical, chemical and microbiological condensate water is low mineral water and safe to consume. Public response is very good and active during the activities and expect desalination device is an alternative solution to overcome the water crisis despite still needed some refinement for increasing its productivity.

Acknowledgements

This project was funded by DP2M Kemenristek-DIKTI through I_bM scheme.

References

- [1] B.Tansel, *Recent Patents on Chemical Engineering*, 1: 17–26 (2008)
- [2] RD Ambashita and M.Sillanpaa, *Journal of Hazardous Materials*, 180: 38-49 (2010)
- [3] Suara Komunitas, Dusun Tebayak, Lombok Utara Kesulitan Air Bersih, (2011) <http://suarakomunitas.net/dusun-terbayak--lombok-utara-kesulitan-air-bersih>
- [4] NTB terkini, *17 Dusun Di Lombok Utara Kekurangan Air Bersih* (2012) <http://ntbterkini.com/17-dusun-di-lombok-utara-kekurangan-air-bersih>
- [5] Sasakura. *Desalination Technology and Its Application*, P.T. Sasakura Indonesia: Jakarta (1995)
- [6] T.Jitsuno, and K. Hamabe. *Journal of Arid Land Studies*. 22(1): 153 -155 (2012).
- [7] Jr. SG. Bethel, DV. Dell'Accio, MF. Haffenreffer, ZT. Modest, MB. Wegma (2012) http://www.mie.neu.edu/ME_2012_04_Low-Cost_.pdf

Production of *Lentinula edodes* (Shiitake mushrooms) on inoculated logs of a range of tree species

Irwan Mahakam Lesmono Aji¹

¹*Study Program of Forestry University of Mataram, Jl. Pendidikan No.37, Mataram 83125, e-mail: irwanmla@unram.ac.id*

Abstract

Shiitake (*Lentinula edodes* (Berkeley) Pegler) produces an edible mushroom that has been cultivated for centuries in China, Korea, Japan, Singapore, Thailand and other Asian countries. Shiitake mushrooms grow naturally on decaying wood of hardwood trees and have traditionally been grown on short lengths of freshly-cut logs. Logs of six tree species were harvested from farm forestry plantations in Victoria and inoculated with shiitake infected dowels imported from the United States. Over the course of the next 18 months the logs were soaked four times to initiate fruiting. The fresh mushrooms were harvested and weighed to allow a comparison between log species and size. *Quercus robur* was the most productive species. Over the course of the trial (four fruitings) the oak logs produced almost 1 kilogram of fresh mushrooms per log which was significantly more than *E. cladocalyx* (527 g/log) and *Alnus glutinosa* (465 g/log) and *Eucalyptus nitens* (389 g/log) which were all, in turn, significantly more productive than *Populus* sp. (140 g/log) and *Acacia melanoxylon* (98 g/log). Larger logs produced more fruit although this may have been related to the greater number of inoculations.

Keywords : *lentinulaedodes, mushroom, production, shiitake.*

1. Introduction

1.1. Background

Shiitake (*Lentinula edodes* (Berk.) Pegler) produces an edible mushroom that has been cultivated for centuries in China, Korea, Japan, Singapore, Thailand and other Asian countries [1]. It is now grown in many other countries including Brazil, Canada, the Netherlands, the United Kingdom and the United States [2] and is the second most commercially marketed mushroom in the world after the button mushroom (*Agaricus bisporus* (J.E. Lange) Imbach) [3 & 4].

Over the last three decades, the commercial production of shiitake mushroom has increased from an estimated 350,000 tons in 1965 to about 7.5 million tons in 2000 [2]. Since the 1950s, mushroom production in Australia has been one of the fastest growing food crop industries and is currently regarded as the second most important fresh vegetable type [5 & 6]. Shiitake production is very small by comparison and has only recently gained recognition as a commercial alternative. In 1994, the total Australian production of specialty mushrooms (of which shiitake and oyster mushrooms are the main types) was thought to be less than 300 tons [7]. By 2005, the domestic market for specialty mushrooms had increased to 1000 tonnes and was expected to continue to grow, albeit at a modest rate [6]. With particular respect to this study, a company in Tasmania is currently producing shiitake mushrooms on a eucalypt-based substrate and selling the product into mainland markets [8].

Although much is known about the life cycle and cultivation of shiitake mushrooms almost all the published research pertaining to the commercial production of shiitake

mushrooms originates from the northern hemisphere, particularly northern Asia and the US, and almost none involves Australian tree species as growth substrates. The RIRDC subsequently funded a research program at the University of Sydney which examined the prospects for producing shiitake mushrooms on an artificial substrate [9]. The researchers suggested that, although the mushrooms produced on a “synthetic sawdust log” were inferior to those produced on logs, the lack of logs of the appropriate hardwood species and a high labour costs meant that the potential of developing an industry based on the use of the log method in Australia was limited. Since this initial research was done there has been little development of the commercial production of shiitake mushroom in Australia.

1.2. Shiitake production

Shiitake mushrooms grow naturally on decaying wood of hardwood trees and have traditionally been grown on short lengths of freshly-cut logs. Modern commercial production has proved successful on both logs and alternative substrates such as wood shavings and peat moss [2]. There has been no serious exploration of the potential for Australian forest owners to utilise small logs of native or plantation forest species for shiitake mushroom production, such as eucalypt (*Eucalyptus* spp.).

While a range of tree species have been used for shiitake production, the most common species used are of oaks (*Quercus* spp.). Alternative species that have been trialled in the northern hemisphere include Alder (*Alnus incana* (L.) Moench), Birch (*Betula pendula* Roth.), Red Oak (*Quercus rubra* L.), Black Cherry (*Prunus serotina* Ehrh.), Sassafras (*Sassafras albidum* (Nuttall) Nees), Eastern Sycamore (*Platanus occidentalis* L.) and China Fir (*Cunningham lanceolata* (Lambert) Hooker [10; 11; 12; 13]. The results suggest that the choice of wood species can affect yield and timing of mushroom production although none have reported any impact of species on the food value of the mushrooms produced [11 & 13].

1.3. Aim and Objectives

The overall aim of this study is to investigate the potential for log-based cultivation of shiitake mushroom on a range of wood species currently available as thinnings from farm forestry plantations in Victoria by comparing them with species commonly used in the northern hemisphere.

2. Methods

2.1. Harvest and inoculation

Logs were stored for a short time prior to inoculation with shiitake (*Lentinula edodes* (Berk.) Pegler) spawn imported from the United States. The inoculation involved drilling many small holes along the length of each log and hammering in a short wooden dowel of alder (*Alnus* spp) which carried the fungal hyphae. Holes and wood's ends are sealed with bees wax to preserve moisture. The inoculated logs were then stacked in a shade house. The logs were watered regularly for more than 4 months prior to being soaked to stimulate fruiting and stacked in fruiting racks for observation and harvesting. The mushrooms produced on each log were harvested and weighed.

2.2. Incubation of logs during mushroom cultivation

Watering logs during the cultivation period depended on daytime temperature. An automatic timing device installed inside the shade house was set to water logs twice a day for

approximately 5 minutes when the temperature remained between 15 to 25 °C. When the temperature in the shade house was between 25 and 35 °C, the automatic watering system was set for watering three times a day with one or two additional periods of watering by spray nozzles. Four automatic watering periods per day along with one or two periods using spray nozzles were necessary when the temperature was over 40 °C. When the mycelium appeared to be well developed in most species and volunteer mushrooms were beginning to appear indicating it was time to soak the logs to initiate fruiting. Soaking was done by un-stacking the logs and submerge it in a large tank (1.5 m diameter and 1 m depth) of water for approximately 24 hours.

3. Results & Discussions

3.1. Log viability

Fruiting was initiated four times during the course of the trial. Although the oak logs were significantly more viable than the logs of any other species in the first fruiting cycle, at least 80% of the logs of each species produced mushrooms in the third fruiting cycle. The results from the fourth fruiting cycle were low across all the species.

3.2. Mushrooms yields

The fresh mushrooms produced from each log during each fruiting period were collected and weighed. Although the oak performed well (70 % viability and a total yield of almost 2 kg per log) during the first fruiting period the poor performance of the other species (less than 30 %) made it impossible to perform any meaningful statistical analysis. Interestingly, an alder log had the highest individual production (600 g). As viability improved over the course of the trial differences in yield between the species became more evident.

Oak again performed well in the second fruiting (90 % viability and an average yield of over 500 g/log). One oak log produced 1 kg of fresh shiitake mushroom in a single fruiting cycle. Their superior early viability and production meant the oak logs had produced, on average, 686 gram of mushrooms in two fruiting cycles compared to just 298 g per log for alder, 255 g per log for sugar gum, 188 g per log for shining gum, 32 g per log for blackwood and 31 g per log for poplar. It was not until the third fruiting cycle that the viability and production from the other species approached that of oak.

Although the average yields from the oak, alder and sugar gum actually declined the third fruiting cycle was, overall, the most successful with log viability across the trial being over 90% and almost 50 per cent of the logs producing more than 200 g of shiitake mushrooms. Table 1 summarise the results and show that, in terms of shiitake production per log, there was no significant difference between the performance of the sugar gum and oak. Shining gum produced significantly less than the oak and sugar gum but more than either the blackwood or poplar. The alder logs were highly variable.

The total production from each species over the course of the four fruitings is presented in Table 1. Oak proved to be significantly better than any other species in the trial producing almost 1 kilogram of fresh produce per log. The eucalypt species and alder were not significantly different producing around 400 to 500 g per log on average for each species. Blackwood and poplar were very poor shiitake producers yielding less than 150 g per log.

Table 1 The yield of fresh mushrooms per log (including unviable logs) for each fruiting cycle and over the course of the trail

Wood Species	No. logs	1st Fruiting			2nd Fruiting		
		Viability (%)	Total yield (g)	Log Yield (g/log)	Viability (%)	Total yield (g)	Log Yield (g/log)
Oak	10	70%	1846	185	90%	5006	501
Blackwood	7	14%	55	8	29%	168	24
Shining gum	10	20%	245	25	70%	1625	163
Alder	7	29%	740	106	57%	1347	192
Poplar	7	14%	60	9	29%	157	22
Sugar gum	7	29%	190	27	86%	1594	228

Wood Species	No. logs	3rd Fruiting			4th Fruiting		
		Viability (%)	Total yield (g)	Log Yield (g/log)	Viability (%)	Total yield (g)	Log Yield (g/log)
Oak	10	100%	2988	299 ^a	20%	74	7
Blackwood	7	100%	449	64 ^d	14%	15	2
Shining gum	10	80%	1697	170 ^b	70%	327	33
Alder	7	86%	1039	148 ^{bc}	57%	131	19
Poplar	7	86%	750	107 ^{cd}	14%	10	1
Sugar gum	7	100%	1885	269 ^a	29%	17	2

Wood Species	No. logs	Total for 4 fruiting		
		Viability (%)	Total yield (g)	Log Yield (g/log)
Oak	10	100%	9914	991 ^a
Blackwood	7	100%	687	98 ^c
Shining gum	10	80%	3894	389 ^b
Alder	7	100%	3257	465 ^{bc}
Poplar	7	86%	977	140 ^c
Sugar gum	7	100%	3686	527 ^b

4. Conclusions

This research compared yield of shiitake mushroom grown on six tree species of oak (*Quercus robur*), sugar gum (*Eucalyptus cladocalyx*), alder (*Alnus glutinosa*), shining gum (*Eucalyptus nitens*), poplar (*Populus* sp.) and blackwood (*Acacia melanoxylon*). Although the yields from oak were the highest and blackwood the lowest, the research clearly demonstrates that shiitake mushrooms can be grown in Victoria on logs of native and introduced species, and that native eucalypt species, such as shining gum and sugar gum, may be viable alternative species for log-based shiitake production in Australia.

References

- [1] Ciesla, W.M. 2002. Non-Wood Forest Products from Temperate Broad-Leaved Trees. FAO. Rome.
- [2] Royse, D.J. 2001. Cultivation of shiitake on natural and synthetic logs. The Pennsylvania State University. Pennsylvania
- [3] Przybyłowicz, P.R. and Donoghue, J 1988. Shiitake Growers Handbook-The art and science of mushroom cultivation. Kendall Hunt Pub Co. Iowa.

- [4] Oei, P 1996. Mushroom cultivation: with special emphasis on appropriate techniques for developing countries. Tool. The Netherlands.
- [5] Davis, J. 2000. 'The edible and medicinal mushrooms industry in Australia'. International Journal of Medicinal Mushrooms. Vol 2. pg. 87-89.
- [6] Australian Mushroom Growers Association (AMGA) 2005. 'State of the Australian Mushroom Industry' in Australian Mushroom Growers Association. Accessed 04 September 2007. From <http://www.mushrooms.net.au/2004_2005_statistics.pdf>.
- [7] Richards, R. 1995. 'Development of the Australian specialty mushroom industry' in Rural Industries Research & Development Corporation. Accessed 09 February 2008. From <<http://www.rirdc.gov.au/pub/compendium/1995/pr-014.html>>.
- [8] Hyde, K. 2000. 'Thirty Australian champions shaping the future for rural Australia' in Rural Industries Research & Development Corporation. Accessed 12 February 2008. From <<http://www.rirdc.gov.au/champions/HuonValleyMushrooms.html>>.
- [9] Cho, K.Y. and Radford, D.V. 1999. 'Cultivation of shiitake mushrooms' in Rural Industries Research & Development Corporation. Accessed 12 February 2008. From <<http://www.rirdc.gov.au/programs/February-1999-Page1.htm>>.
- [10] Shieh, J.C., Hwang, S.G. and Sumimoto, M. 1991. 'Cultivation of shiitake mushrooms on the logs of a conifer, *Cunningham lanceolata*'. Mokuzai Gakkaishi. Vol. 37. No. 3. pg. 266-274.
- [11] Raaska, L 1992. 'The growth of shiitake (*Lentinula edodes*) mycelium on alder (*Alnus incana*) and birch (*Betula pendula*) wood logs'. Material und organismen. Vol. 27. Issue 2. pg. 117-134.
- [12] Shukla, A.N. 1994. 'Cultivation of Japanese mushroom shiitake in India'. The Indian Forester. Vol 120. Issue 8. pg. 714-719.
- [13] Sabota, C 1996. 'Strain of shiitake mushroom [*Lentinula edodes* (Berk.) Pegler] and wood species affect the yield of shiitake mushrooms'. HortTechnology. Vol 4. Issue 4. pg. 388-393

Shear Analysis And Design of Reinforced Concrete Interior Beam Column Joint Using King Cross Steel Profile

Rahmani Kadarningsih^{1,2,*}, Iman Satyarno¹, Muslikh¹, Andreas Triwiyonono¹

¹Department of Civil and Enviromental Engineering Universitas Gadjah Mada, Yogyakarta, Indonesia

²Departement of Civil Engineering Universitas Negeri Gorontalo, Gorontalo, Indonesia

* Email: rahmanikadarningsih@rocketmail.com

Abstract

This paper discuss the analysis and design of king cross steel profile to be implemented as alternative reinforcement in reinforced concrete beam-column joints. King Cross is a built-up or fabricated steel section. Standard sizes can be made by welding 2 T-Beams into the web of a hot rolled IWF, forming the shape of a cross. With the simplifying assembling the use of King-cross steel profile implants at beam-column-joints as a shear reinforcement could be expected to replace the transversal reinforcement and enhance the joint shear strength. Therefore various arrangements of beam-column reinforcement are studied analytically. These include beam-column joint without reinforcement at all, beam-column joint with king cross steel profile reinforcement, and beam-column joint with combination of king cross steel profile and conventional steel bars reinforcement. Theoretically the application of king cross steel profile can reduce the need of conventional steel bars reinforcement. Moreover as the king-cross steel profile can fully resist the developed shear stress, it may not necessary to introduce a limitation of shear stress in the reinforced beam column joint.

Keywords: beam column joint, joint shear capacity, joint shear strengthening, joint shear stirrup, king cross steel profile.

1. Introduction

In special momen resisting frame structure, the beam column joint is a crucial area that require special design. In a condition that the need of joint shear capacity is high so that required high amount of steel bars reinforcement in beam-column joints. The large requirement of the joint stirrup causes the space of the stirrups is too dense and difficulties for assembling. With this background, the king cross steel profile is used to increase the shear capacity in the joint and to reduce steel bars reinforcement in beam-column joints. To compare the effect of king cross steel profile on the joint shear capacity then made some design of the eksperimental specimen. The design is shown in Table 1.

Table 1. Comparision the joint shear strength design type beam column joint

No	Spesimen	Shear strengtening of beam column joint	Purpose
1	BCJ1	Without strengthening	Find out concrete shear capacity
2	BCJ2	0,07Vs stirrup design	compare the shear capacity of BCJ2 to BCJ3
3	BCJ3	0,07Vs king cross profile desin	
4	BCJ4	0,14Vs stirrup design	compare the shear capacity of BCJ4 to BCJ5 and BCJ3 to BCJ5
5	BCJ5	0,14Vs king cross profile desin	
6	BCJ6	The combination of 0,07Vs stirrup design and 0,07Vs king cross profile desin	compare the shear capacity of BCJ6 to BCJ4

2. Determine the material properties and the beam column joint dimension

The dimensions and material properties of the beam column joint (Figure 1) that is designed based on the analysis of two-storey structures in seismic regions [1] are as follows:

The concrete compressive strength $f'_c = 30$ MPa

The yield strength of longitudinal bar $f_y = 423,68$ Mpa

The yield strength of transversal bar $f_y = 387.93$ Mpa

The yield strength of web king cross profile $f_y = 203,7$ Mpa

The yield strength of flens king cross profile $f_y = 237,15$ Mpa

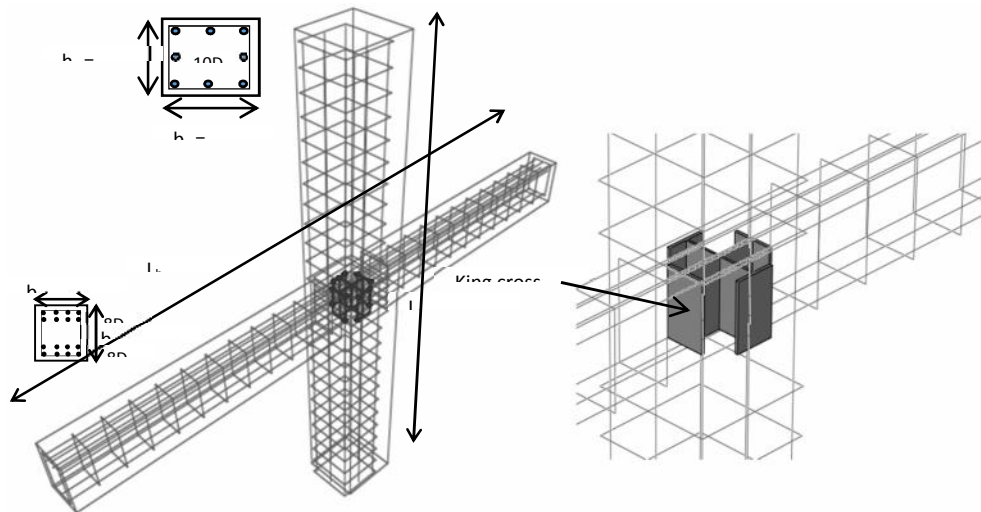

3. Calculate the design shear force of beam column joint

The magnitude of the shear force of the joint is the difference in the amount of the beam tension and the compression force to the horizontal shear force that works on the column.

$$V_u = T_s + C_s - V_c \tag{1}$$

The amount of the shear force design is calculated by various method and are tabulated as Table 2. The analysis results show that the calculation of the beam moment ($M_{pr,b}$), the column shear force (V_c), the beam tension force (T_s) and the beam compression force (C_s) of all the method are similar sufficiently. So that the calculation result of the joint shear force design (V_u) can be consider significant. And to expect the joint failure than is taken The smallest V_u value is $V_u = 1036,59$ kN.

Table 2 The joint shear force design (V_u)

Analysis method	M beam ($M_{pr,b}$)	Column shear force (V_c)	Beam tension (T_s) and compression force (C_s)	The joint shear force design (V_u)
ACI- ASCE (352R-02) [2]	$M_{pr,b1} = A_{s1}\alpha f_y \left(d - \frac{a}{2}\right) = 115,14 \text{ kNm}$ $M_{pr,b2} = A_{s2}\alpha f_y \left(d - \frac{a}{2}\right) = 115,14 \text{ kNm}$	$V_c = \sqrt{f'_c} \cdot 1 + V_{c2} = \frac{(M_{pr,b1} + M_{pr,b2}) \left(1 + \frac{h_c}{2l_b}\right)}{l_c} = 88,13 \text{ kN}$	$T_s = \alpha f_y A_{s1} = 562,36 \text{ kN}$ $C_s = \alpha f_y A_{s2} = 562,36 \text{ kN}$	$V_u = T_s + C_s - V_c = 1036,59 \text{ kN}$
Park and Paulay, 1974 [3]	$M_{pr,b1} = A_1 \alpha f_y \left(d_1 - d'_1\right) = 102,91 \text{ kNm}$ $M_{pr,b2} = A_2 \alpha f_y \left(d_2 - d'_2\right) = 102,91 \text{ kNm}$	$V_c = \sqrt{f'_c} \cdot 1 + V_{c2} = \frac{(M_{pr,b1} + M_{pr,b2}) \left(1 + \frac{h_c}{2l_b}\right)}{l_c} = 78,77 \text{ kN}$	$T_s = \alpha f_y A_{s1} = 562,36 \text{ kN}$ $C_s = \alpha f_y A_{s2} = 562,36 \text{ kN}$	$V_u = T_s + C_s - V_c = 1045,94 \text{ kN}$
Response 2000	$M_{pr,b1} = 107,4 \text{ kNm}$ $M_{pr,b2} = 107,4 \text{ kNm}$	$V_c = \sqrt{f'_c} \cdot 1 + V_{c2} = \frac{(M_{pr,b1} + M_{pr,b2}) \left(1 + \frac{h_c}{2l_b}\right)}{l_c} = 82,207 \text{ kN}$	$T_s = 52,9 \text{ kN}$ $C_s = 59 \text{ kN}$	$V_u = T_s + C_s - V_c = 1015,79 \text{ kN}$

4. Calculate the concrete, stirrup and king cross steel profile shear capacity of joint

The joint shear capacity (V_u) contributed by the concrete shear capacity (V_c) and the shear capacity of the joint stirrup (V_s), so formulated as follows:

$$V_u = V_c + V_s \quad (2)$$

The concrete shear capacity of joint (v_c) according to Park and Paulay are calculated by a beam shear design without stirrups that sustain the shear forces and the axial compression. ACI 318-71 permit the use of more simple equation to calculate V_c that undergo the column axial force (N_u) in column area (A_g) into [2]

$$v_c = 0.2905\sqrt{f'_c} \sqrt{1 + 0.2903 \frac{N_u}{A_g}} \quad (MPa) \quad (3)$$

The shear capacity of the joint stirrup (V_s) is calculated using three methods:

- 1) The shear capacity of the joint stirrup based on the truss mechanism [2]

$$A_v = v_s \frac{sb_w}{f_y} \quad (4)$$

- 2) The shear capacity of the joint stirrup based on acting force mechanism on the joint and near joint element [2]

$$A_v = \frac{V_s s}{(a-d')f_y} \quad (5)$$

- 3) The shear capacity of the joint stirrup based on SNI 03-2847-1992 [4]

$$A_{jh} = \frac{V_s h}{f_y} \quad (6)$$

The shear strength contributions of the king cross steel profile are

- (1) The contribution of the web of the king cross section

For columns with the king cross steel section as in Figure 2, the shear strength of the joint along the plane of the web is mainly retained by the web. According to the specifications of AISC - LRFD, the shear strength is retained by the web V_{sw} as [5],[6]

$$V_{sw} = 0.6F_{yw}d_c t_w \quad (7)$$

- (2) The contribution of the flange of the king cross section

In addition it is also proposed the shear strength that is provided by two longitudinal flanges V_{slf} which is estimated at [6]

$$V_{slf} = 2 \times \left[\frac{2}{3} (0.6F_{yf} \times A_f) \right]$$

- (8) And then the beam column joint shear design is concluded in Table 3.

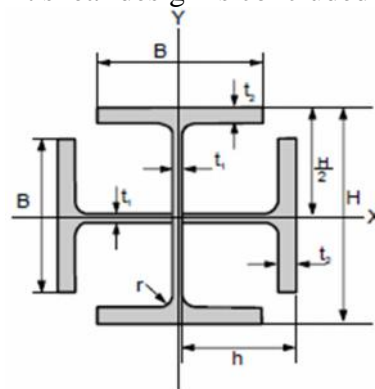

Figure 2.. King cross profile cross section

Table 3 The joint shear design

Specimen	Shear strengtening of beam column joint	Stirrup of joint design	The dimension design of king cross profile
BCJ1	Without strengthening		
BCJ2	0,07Vs stirrup design	650,5	
BCJ3	0,07Vs king cross profile desin		H = 60 mm B = 30 mm t1 = 2 mm t2 = 3 mm
BCJ4	0,14Vs stirrup design	6101	
BCJ5	0,14Vs king cross profile desin		H = 95 mm B = 50 mm t1 = 2 mm t2 = 3 mm
BCJ6	The combination of 0,07Vs stirrup design and 0,07Vs king cross profile desin	650,5	H = 60 mm B = 30 mm t1 = 2 mm t2 = 3 mm

References

- [1] M. Wijaya, *Retrofitting Of Reinforced Concrete Interior Beam-Column Joints Using Polyester Resin Concrete*, Thesis, Civil Engineering Graduate Program Gadjah Mada University, Yogyakarta, 2015.
- [2] ACI – ASCE Committee 352 (ACI 352R-02), *Recommendation for Design of Beam – Column Connections in Monolithic Reinforced Concrete Structure*, American Concrete Institute, Farmingham Hils, MI, 2002.
- [3] Park, R. dan Paulay, T., *Reinforced Concrete Structures*, Jhon Wiley, New Zealand, 1975.
- [4] BSN, SK SNI T-15-1991-03, *Tata Cara Perhitungan Struktur Beton untuk Bangunan Gedung*
- [5] AISC 360-10, *Specification for Structural Steel Buildings*
- [6] Chen, C. dan Lin, K., Behavior and strength of steel reinforced concrete beam – column joints with two-side force inputs, *Journal of Constructional Steel Research*, 65: 2009, 641–649

Polytomous Logistic Regression in Analyzing the Presence of National Pilot Mosque in Karang Baru Mataram, 2016

Nurul Fitriyani^{1*}, Lailia Awalushaumi¹, Agus Kurnia¹

¹*Department of Mathematics, University of Mataram
Jalan Majapahit No. 62 Mataram 83125, Indonesia
Email: nurul.fitriyani@unram.ac.id

Abstract

The objective of the article was to explore the usage of Polytomous Logistic Regression (PLR) in analyzing the presence of National Pilot Mosque in Mataram City, especially in Karang Baru year 2016. PLR is used to predict a dependent variable (with more than two categories) given one or more explanatory variables. PLR shows how multinomial response variable Y depends on a set of k explanatory variables, $X = (X_1, X_2, \dots, X_k)$. In this study, the PLR was used to determine the effect of the Quality of Idarah, the Quality of Imarah, and the Quality of Ri'ayah to the existence of the National Pilot Mosque, measured by the intensity of visits to mosques in Mataram City, especially in Karang Baru year 2016. This research used primary data, which was obtained through questionnaires at some point in Karang Baru. The application of PLR in analyzing the presence of National Pilot Mosque especially in Karang Baru, Mataram has not been done before. Therefore, this study was expected to be the first step to help the government in order to develop the potential of human resource through the presence of the National Pilot Mosque.

Keywords: *National Pilot Mosque, Polytomous Logistic Regression, Regression Model*

1. Introduction

In order to improve the function of the mosque, Ministry of Religious Affairs as a state institution that function in the development of religious life need to provide guidance and appreciation to the mosque committee. The government should give an adequate attention to the mosque manager (Takmir) in the management and the prosperity of the mosque by seeing their magnitude task and role. The attention could be like the development, evaluation, and assessment of the performance of all the elements in the mosque, in according to create the mosque which have the best quality that can be used as National Pilot Mosque. In order to develop and establish the National Pilot Mosque, the pilot mosque assessment should be carried out gradually from the national, provincial, and district or city.

This study was conducted to analyze the correlation between the presence of the National Pilot Mosque in Kota Mataram, particularly in Karang Baru year 2016, with some of the factors that influence it. If the relationship be known, then the next steps that can be taken by the relevant institutions can be more focused. Therefore, we need a statistical analysis, such as regression analysis, to determine the pattern of the relationship.

Regression analysis is a statistical analysis used to determine the relationship between the dependent variable and the independent variables [1]. Logistic regression model can be used when the dependent variable is categorical [2]. Logistic regression model with two categories in the dependent variable is called a binary logistic regression model, while the model with more than two categories in the dependent variable called polytomous logistic regression (PLR) models [3]. Therefore, the aim of the research was to analyzed the relationship between the presence of the National Pilot Mosque measured by the intensity of the visits to the

mosques in Kota Mataram, particularly in Karang Baru, year 2016, with some of the factors that influence it by using PLR.

2. Materials and Methods

The data used in this study were primary data obtained through questionnaires and interviews. In addition, the researchers also used secondary data obtained from the West Nusa Tenggara Central Bureau of Statistics.

The presence of the National Pilot Mosque was measured by the intensity of the visits to the mosque (Y), which was expressed in three categories. The category was $Y = 0$ for a visit to the mosque "less than twice"; $Y = 1$ for a visit to the mosque "two to four times"; and $Y = 2$ for a visit to the mosque "more than four times". The independent variables used consisted of the Quality of Idarah (X_1), the Quality of Imarah (X_2), and the Quality of Ri'ayah (X_3) on mosques in Mataram, particularly in Karang Baru year 2016. Each of these independent variables expressed in three categories, i.e. $X = 0$ for the quality of mosque "Low"; $X = 1$ for the quality of the mosque "Moderate"; and $X = 2$ for the quality of the mosque "High". Each independent variable consisted of several sub-variables using Likert scale.

Idarah are the development and the cooperation regulation activities of many people in order to achieve a particular purpose such as planning, organization management, administration, finance, and supervision. Imarah is an attempt for the prosperity of the mosque as a place of worship, coaching people, and improving the welfare of the pilgrims as an implementation program of Five Time Worship Prayer, Friday Prayer, training of Imam, Khatib, Muadzin, and the development of worshipers, education such as Taklim Assembly, Economic Empowerment for people, like cooperative and Baytul Mal, organizing the Islamic and the National Day, Mosque Clinic, and the others. Whilst, Ri'ayah means the development of facilities and infrastructure of mosque, such as the architectural form of the building, the maintenance of the damage, maintenance of hygiene, maintenance of equipment and facilities, and so forth [4], [5].

The statistical analysis steps were as follows: (1) Study of literature; (2) Determination of the formulation of the problem and research objectives; (3) Variables identification; (4) Data collection; (5) Validity and reliability test; (6) Data analysis; (7) Results and discussion; and (8) Conclusion.

3. Results and Discussion

PLR was used to analyze the relationship between the presence of the National Pilot Mosque measured by the intensity of visits to the mosques in Kota Mataram, particularly in Karang Baru year 2016, with several factors that influence it. The descriptive statistics of all the variables studied given in Table 1 as the initial value. This was to know the characteristics of the data that were used.

Table 1 shows that the average number of the intensity of visits to the mosque was 1 ($Y = 1$, meaning that a visit to the mosque was 2 to 4 times a day), with a deviation standard of 0.803. the average number of Quality of Idarah was 1.79 (more directed to the mosque with high quality), with a deviation standard of 0.461. Furthermore, the average number of Quality of Imarah was 1.42 (more directed to the mosque with moderate quality), with deviation standard of 0.495. The average number of Quality of Ri'ayah was 1.45 (more directed to the mosque with moderate quality), with deviation standard of 0.499.

Table 1 Descriptive Statistics of Data

No	Variable	Mean	Deviation Standard
1	Intensity of Visits to Mosque (Y)	1.00	0.803
2	Quality of Idarah (X ₁)	1.79	0.461
3	Quality of Imarah (X ₂)	1.42	0.495
4	Quality of Ri'ayah (X ₃)	1.45	0.499

Based on the Goodness-of-Fit results, the p-value of Pearson chi-square statistic was 0.369 (i.e., $p = 0.369$) and is, therefore, not statistically significant. A statistically significant result (i.e., $p < 0.05$) indicates that the model does not fit the data well. Based on this measure, the model fits the data well.

Another option to get an overall measure of the model is to consider the statistics presented in the Model Fitting Information. This measure can be used to consider whether the variables added, were statistically significantly improve the model compared to the intercept alone (i.e., with no variables added). The p-value of final model using likelihood ratio test was 0.000 ($p = 0.000$), which means that the full model statistically significantly predicts the dependent variable better than the intercept-only model alone.

The greater importance were the results presented in Table 2, which considered the overall effect of a variable (overall statistical significance value), as shown below:

Table 2 Likelihood Ratio Test

No	Effect	Chi-square	Sig.
1	Intercept	0.000	.
2	Quality of Idarah (X ₁)	13.371	0.010
3	Quality of Imarah (X ₂)	14.283	0.001
4	Quality of Ri'ayah (X ₃)	5.221	0.073

Table 2 shows which of the explanatory variables were statistically significant. It can be seen that the Quality of Idarah variable was statistically significant because $p = 0.010$ (the "Sig." column). On the other hand, the the Quality of Imarah variable was also statistically significant because $p = 0.001$. The last variable, Quality of Ri'ayah, was statistically significant by seeing $p = 0.073$ compared to the significance level ($\alpha = 7.5\%$). Based on this results, the explanatory variables (the Quality of Idarah, Imarah, and Ri'ayah) significantly affected the dependent variable (the Intensity of Visits to Mosques).

Unlike the Likelihood Ratio Test in Table 2, Table 3 below represents the parameter estimates (also known as the coefficients of the model). It represents the estimated PLR coefficients for the models. The PLS estimated *k-1* models, where $k = 3$ was the number of categories of the dependent variable. As there were three categories of the dependent variable (Y), we can see that there were two sets of logistic regression coefficients (two logits), with "> 4 times" visits as the reference category. The first set of coefficients were found in the "< 2 times" row. This represented the comparison of the "< 2 times" visits category to the reference category. The second set of coefficients were found in the "2 – 4 times" row. This represented the comparison of the "2 – 4 times" visits category to the reference category. It can be seen that each dummy variable has a coefficient for each of the explanatory variable (X₁, X₂, and X₃). Therefore, since the parameter estimates were relative to the reference category, the standard interpretation of the PLR is that for a unit change in the independent variable, the logit of dependent relative to the reference category is expected to change by its respective parameter estimate given the variables in the model were held constant.

Table 3 Parameter Estimate

Intensity of Visits to Mosque (Y)		B	Std. Error	Wald	Sig.	Exp(B)
< 2 times	Intercept	-0.791	0.317	6.237	0.013	
	[X ₁ =0]	20.145	1.149	307.485	0.000	5.610E8
	[X ₁ =1]	0.825	0.544	2.304	0.129	2.283
	[X ₁ =2]	0 ^b
	[X ₂ =1]	1.194	0.360	10.991	0.001	3.299
	[X ₂ =2]	0 ^b
	[X ₃ =1]	-0.002	0.359	0.000	0.997	0.998
2 - 4 times	[X ₃ =2]	0 ^b
	Intercept	-0.342	0.285	1.435	0.231	
	[X ₁ =0]	19.093	0.000	.	.	1.958E8
	[X ₁ =1]	1.435	0.509	7.955	0.005	4.201
	[X ₁ =2]	0 ^b
	[X ₂ =1]	1.079	0.351	9.475	0.002	2.942
	[X ₂ =2]	0 ^b
[X ₃ =1]	-0.670	0.350	3.672	0.055	0.511	
[X ₃ =2]	0 ^b	

There were 6 (six) coefficients (the "B" column) that were statistically significant, compared to the compared to the significance level (alpha = 7.5 %). The coefficients were: (1) coefficient for the intercept of the first set (p = 0.013, from the "Sig." column); (2) coefficient for [X₁=0] of the first set (p = 0.000); (3) coefficient for [X₂=1] of the first set (p = 0.001); (4) coefficient for [X₁=1] of the second set (p = 0.005); (5) coefficient for [X₂=1] of the second set (p = 0.002); and (6) coefficient for [X₃=1] of the second set (p = 0.055).

4. Conclusion

The Quality of Idarah, the Quality of Ibadah, and the Quality of Ri'ayah significantly affected the Intensity of Visits to Mosques, by seeing the overall effect (overall statistical significance value). It can clearly be seen that the three qualities of mosque affected the presence of the National Pilot Mosque measured by the intensity of visits to mosque in Mataram City, especially in Karang Baru, year 2016. By this results, showed that the government could increase the quality of Idarah, Ibadah, dan Ri'ayah, in order to increase the intensity of visits to mosques in Mataram City, especially in Karang Baru.

References

[1] Eubank, R.L., *Spline Smoothing and Nonparametric Regression 2nd Ed.*, New York, Marcel Dekker, 1999.
 [2] Agresti, A., *An Introduction to Categorical Analysis 2nd Ed.*, New Jersey, John Wiley & Sons, Inc., 2007.
 [3] Hosmer, D. W. and Lemeshow, S., *Applied Logistic Regression 2nd Ed.*, New York, John Wiley & Sons, Inc., 2000.
 [4] Kanwil Kemenag Riau (tt). *Mosque Management (Idarah, Ibadah, and Ri'ayah aspect)*, accessed from riau.kemenag.go.id/file/file/urais/iegc1422345631.pdf, on April 12th, 2016.
 [5] The Director General of the Islamic Community Guidance, *the Director General of the Islamic Community Guidance No. DJ.II/ 725 year 2013 about Technical Guidelines for Assessment Pilot National Mosque*, accessed from <http://gorontalo.kemenag.go.id/file/file/BimasIslam/nowj1384413733.pdf>, on April 12th, 2016.

Shear Capacity Of Hybrid Coupling Beam

Nursiah Chairunnisa^{1,2*} Iman Satyarno¹, Muslikh¹, Akhmad Aminullah¹

¹Civil and Environmental Engineering Department of Gadjah Mada University, Yogyakarta, Indonesia

²Civil Engineering Department of Lambung Mangkurat University, Banjarmasin, Indonesia

* Email: chairunnisaftunlam@gmail.com

Abstract

Coupled shear-wall structures are commonly applied for intermediate and high rise building to provide the withstand of lateral loading caused by an earthquake and wind loading. The failure mechanism of coupling beams affect the behaviour of coupled shear wall system because coupling beams are normally imposed to high shear stresses. The use of steel truss in coupling beam is considered as a new alternative method of coupling beam, solution to the problem for enhancing shear strength in coupling beam. The use of steel truss coupling beam encased in reinforced mortar can restrain the shear behaviour of coupling beam. This paper presents the analytical analysis shear design of various type of coupling beams including diagonal reinforced concrete coupling beam, steel truss coupling beam with and without buckling consideration and hybrid coupling beam that using steel truss encased in reinforced mortar. All type of coupling beams will be designed with the scale of 1:2.5 and span to depth ratio of model is 1.78 that requires for diagonal bars according to SNI 2847:2013 as the building code requirements for structural concrete under seismic design in Indonesia

Keywords: *coupled shear-wall, coupling beam, steel truss, reinforced mortar*

1. Introduction

SNI-2847:2013 Building Code Requirements for Structural Concrete [1] is the guideline for seismic design in Indonesia. This code requires the use of diagonal reinforcement for coupling beams having span-to-depth ratios lower than two. Moreover, The experimental test of [2] described that diagonal arrangement of reinforcement for coupling beam present sufficient resistance of shear strength for deep coupling beam with small span-to-depth ratios. Unfortunately, the applying diagonal reinforcement is difficult to construct on site. The utilizing steel truss reinforcement is considered as the alternatives method of coupling beam with encased in reinforced mortar for substituting the diagonal bars of coupling beam. This paper describes analytical analysis for various type of coupling beam using steel truss and encased mortar including diagonal reinforced concrete coupling beam.

2. Design of coupling beams

To asses the shear capacity of coupling beams, 10-stories building and span-to-depth ratio for coupling beam less than two for each level was chosen as a prototype coupled shear wall structure that adopted from [3] Assumed member sizes of structure are shown in Table 1 and 8th level was chosen as a model for experimental phase.

Table 1. Geometry and Shear forces of Prototype Structures of Coupled Shear wall [3] and [4]

No	Level	Width	Depth	Shear force (kN)		Material Properties
				[3]	[4]	
		(b)	(h)			
1	8	300	800	456	422.07	Beam reinf $f_y = 275$ MPa
2	7	350	800	592	555.03	
3	6	350	800	644	609.57	Hoop/tie reinf $f_y = 275$ MPa
4	5	350	800	676	647.37	Concrete $f_c' = 30$ MPa
5	4	350	800	669	643.16	(above level 3) $f_c' = 25$ MPa
6	3	350	800	592	550.56	
7	2	350	1500	908	1212.17	

The target shear capacity for all models of coupling beams are taken as 422.07 kN was adopted from previous researchers [4] as a prototype structures and all type of coupling beams will be created with the scale of 1:2.5. Design procedures for these models based on SNI 2847:2013 [1] and are basically based on a simple truss analogy for steel truss and hybrid coupling beam [4]. The dimension of coupling beams models is 120 mm x 225 mm with length of beam is 400 mm. Span-to-depth ratio of models is 1.78 and V_u exceeding $0.33\sqrt{f_c'}A_{cw}$. The target of cylindrical compressive strength is 25 MPa.

3. Diagonal reinforced concrete coupling beam.

Shear capacity of diagonal reinforced concrete coupling beam is provided by concrete transversal and diagonal reinforcements contribution. This model can be shown in Fig.1

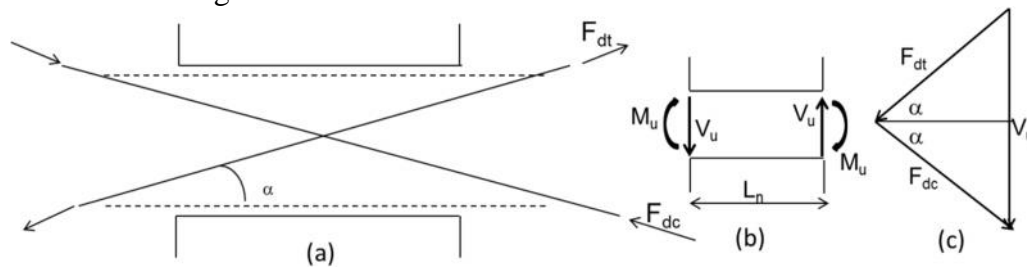

Fig.1. Model of diagonal coupling beam (a) configuration of diagonal bars

$$V_{total} = V_c + V_s + V_{diagonal} \quad (1)$$

Transversal bars shall be distributed along coupling beam with total area not less than $0.002b_w s$. So, the next step is to calculate the required area of diagonal bars according to Eq. 2. Each groups of diagonal bars have to comprise with four reinforcements.

$$V_n = 2A_{vd}f_y \sin r \leq 0.83\sqrt{f_c'}A_{cw} \quad (2)$$

where α is the angle between the diagonal reinforcement and longitudinal axis of coupling beam.

Diagonal bars should be encased by transverse reinforcement with outer dimension not less than $b_w/2$ in direction parallel with b_w and $b_w/5$ for other sides.

4. Steel truss coupling beam

The use of steel truss coupling beam is considered as an new alternative method of coupling beam, solution to the problem for enhancing shear strength in coupling beam. In this study, the steel truss coupling beams consist of double angle steel and angle steel profiles. The diagonal force component (F_d) and the shear resistance of steel truss can be obtained by Eq.3.

$$F_D = A_s f_y \text{ and } V_{steeltruss} = 2F_D \sin \tau \quad (3)$$

Model 3 can be defined as model 2 with buckling consideration design. In this model, diagonal and longitudinal members have to fulfill buckling requirement according to SNI 1729:2015 [5] as Specification for Structural Steel Building as the guideline in Indonesia that can be enclosed as Eq. 4 and Eq.5

$$\text{If } \frac{Kl}{r} \leq 4.71 \sqrt{\frac{E}{f_y}} \text{ or } \frac{f_y}{F_e} \leq 2.25 \text{ and } F_e = \frac{f^2 E}{\left(\frac{kL}{r}\right)^2} \text{ with } F_{cr} = \left[0.658 \frac{f_y}{F_e} \right] \quad (4)$$

and

$$\frac{Kl}{r} > 4.71 \sqrt{\frac{E}{f_y}} \text{ or } \frac{f_y}{F_e} > 2.25 \text{ with } F_{cr} = 0.877 F_e \quad (5)$$

The total capacity of diagonal members and shear capacity in model 3 is calculated by Eq.6

$$F_{D(model3)} = A_s F_{cr} \text{ and } V_{steeltruss} = 2F_{D(model3)} \sin \tau \quad (6)$$

5. Hybrid coupling beam

Hybrid coupling beam is model 4 that can be defined as steel truss coupling beam encased in reinforced mortar. The utilizing of encased reinforced mortar in steel truss is to prohibit premature buckling and enhance the shear capacity of coupling beam. The shear resistance of this model is provided by steel truss and reinforced mortar. The design procedural this model similar with steel truss coupling beam in model 2. Additionally, design of reinforced mortar can be designed as ordinary reinforced concrete beam. The total shear resistance provided by hybrid steel truss as model 4 is calculated by Eq. 7

$$V_{total} = V_{mortar} + V_s + V_{steeltruss} \quad (7)$$

The shear capacity and the geometric dimension of those type of coupling beams models are tabulated in Table 2 and Table 3.

Table 2. Shear capacity of various arrangement reinforcement of coupling beams

No	Type of coupling beams	Vc / Vmortar (kN)	Vs (kN)	Vd (kN)	Vtotal (kN)
1	Diagonal reinforcement	20.10	21.08	32.99	74.17
2	Steel truss without buckling consideration	-	-	68.23	68.23
3	Steel truss with buckling consideration	-	-	88.64	88.64
4	Hybrid steel truss	18.58	20.93	59.49	98.99

Table 3. Geometry dimension of design various type of coupling beam models

Diagonal reinforced coupling beam	Steel truss coupling beam without buckling consideration		Steel truss coupling beam with buckling consideration		Hybrid coupling beams			
	Horizontal Element	Diagonal Element	Horizontal Element	Diagonal Element	Horizontal Element	Diagonal Element	Reinforced mortar with f_c' mortar=30Mpa	
Diagonal bars	Double Angle Steel	Angle steel	Double Angle Steel	Angle steel	Double Angle Steel	Angle steel	Longitudinal Bars	Transversal Bars
4 ϕ 6	2L 30.30.3	L.30.3 0.3	2L35.3 5.3	L35.3 5.3	2L 30.30.3	L.30.3 0.3	2 ϕ 6	ϕ 6-200

Geometry sketch of test specimens and reinforcement details are shown in Fig. 2.

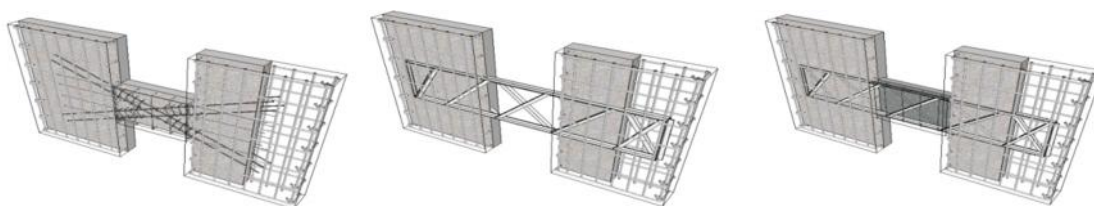

Fig.2 Geometry sketch of various type of coupling beams models (a) Model-1, (b) Model-2 & 3 and (c) Model-4

References

[1] SNI 2847:2013, *Persyaratan Beton Struktural untuk Bangunan Gedung*, BSN, Jakarta, 2013.
 [2] T. Paulay., Binney, J. R."Diagonally Reinforced Coupling Beams of Shear Walls, Shear in Reinforced Concrete, SP-42." American Concrete Institute, Farmington Hills, Mich., pp. 579-598.1974.
 [3] T. Paulay, M.J.N. Priestley, *Seismic design of reinforced concrete and masonry building*, John Wiley and Sons Inc, New York, 1992.
 [4] N. Chairunnisa, I. Satyarno, Muslikh, A.Aminullah, "Analysis and Design of Shear Wall Coupling Beam using Hybrid Steel Truss Encased in Reinforced Mortar", *3rd International Conference on Sustainable Civil Engineering Structures and Construction Materials 2016 (SCESCM 2016)*, Bali, Indonesia, 2016.
 [5] SNI 1729:2015, *Spesifikasi untuk Bangunan Gedung Baja Struktural*, BSN, Jakarta, 2015.

The Modification and Analyzing of heat Loss of The Heater System in The Knockdown Fumigator Type

M. Munandar Prayuda¹, Sukmawaty², Guyup Mahardhian D.P.²

¹*Undergraduate Department of Agricultural Engineering, Faculty of Food and Agroindustrial Technology, University of Mataram*

²*Lecturer Department of Agricultural Engineering, Faculty of Food and Agroindustrial Technology, University of Mataram*

Email : Sukmawaty14@yahoo.com

Abstract

The development of fumigator has reached much increase. One of them is the fumigator knockdown type. But in that fumigator the substance which is smoked do not smoked well, the substance disposed baked than smoked. On that case, it needed modification in order to make the substance can be smoked well. The purposes of this research are to modify and to analyze the system of the heater of fumigator knockdown type. The experimental method was used in this research. The data and adding biomass 0,5 kg taken in every 30 minutes in 8 hour. Parameters taken are temperature, the energy that produces by biomass, heat loss, and the efficiency of heat system. The modifications are to separate the system of heater with fumigation room by using burner in form of cube in dimension 0.35 X 0.35 X 0.35 with 28 kg capacity of piece of coconut shell, blower and two distributor pipe. The heat loss of this fumigator system occurred at burner and distributor pipe smoke. The result of this research shows that heat loss at burner and distributor pipe smoke are the combination of heat loss by convection, conduction, and radiation. The total energy of the heat loss at hearth is 8802.042 KJ, and the distributor pipe smokes are 307.68 KJ. The efficiency of the burner and the heater system are 40.40% and 38.32% respectively.

Keywords: *heat loss, system heater, fumigation*

1. Introduction

Fumigation can be defined as the process of penetration of volatile compounds in fish produced from burning wood which produce product with specific taste and flavor (Bower, et al, 2009). Fumigation also extend the shelf life because of the antibacterial activity (Abolagba and Igbinevbo, 2010), inhibit enzymatic activity in fish which can affect the quality of smoked fish (Kumolu- Johnson et al., 2010).

The traditional fumigation has many drawbacks, including long time process, low fuel efficiency, more heat waste, and low level of hygiene. Base on these problems, it is need the appropriate innovation for fumigation process by using fumigator.

Fumigator with biomass as fuel is expected to improve the efficiency of the agricultural processing product. The types of biomass fuel used are wood, coconut shell, saws husk, coco and others.

Model of fumigator has been widely developed, among others are fumigator rack type, oven model, and knock down type. This research used knock down type. This fumigator is designed to be easily taken anywhere so it can be used anywhere. Based on the designer, this fumigator has disadvantage which the product not smoked well because the product was baked than smoked. This condition occurs because the heating system used located just below

the fumigation chamber so the heat was distributed more widely obtained from the wall of the fumigation chamber.

Based on that reason, it is needed to modify this fumigator so that the heating system separately from the fumigator chamber and also needed blower to blow the smoked into the fumigation chamber. Therefore, to get the result as desired it is necessary to know the heat blown into the fumigator chamber, heat loss in the heating system, and heat loss in the conduit. It is expecting that the heat generated by heating system is not vain. The objective of this study is to determine the amount of heat generated and heat lost in heating system during fumigation process of knock down type of fumigator after modification and analysis of heat lost on heating system.

2. Materials and Methods

2.1. Materials and Equipments

The material used in this study is coconut shell. Equipment used are: a set of knock down type of fumigator, cutting machine, welding machine, measurer tape, elbow ruler, thermocouple, data logger, an analytical balance, thermometer

2.2. Research Step

Investigation steps were as follows : Preparing equipment and materials, modification to the heating system, preliminary study to determine the condition of the equipment, measuring the research parameters such as temperature, energy produced by biomass, the amount of energy come into the fumigator chamber, heat lost during fumigation process. Addition of biomass and data retrieval was done every 30 minutes.

2.3. Calculation parameters

Temperatures observed were on furnace, conduit pipe, and ambient temperature. Furnace temperatures were on the biomass in the furnace and all sides furnace walls. On the conduit pipe were temperatures in and out of the pipe.

Energy generated by fuel coconut shell calculated by (Keating, 2007):

$$Q_f = m_f \times HHV \dots\dots\dots(1)$$

Key :

Q_f = heat energy of combustion of biomass, (kJ)

m_f = biomass fuel mass burned during combustion, (kg)

HHV = heat value of biomass fuel combustion per unit mass, (kJ/kg)

Heat lost in biomass furnace occurs on the wall, either on vertical or on horizontal walls. The accumulation of heat lost on the vertical and horizontal wall of furnace can be calculated by the formula (Holman, 1981):

$$Q = (u \times (T_g - T_{\infty})) + \left(\frac{K_b}{A} \times \Delta x \times \Delta T\right) + (\sigma \times A \times \epsilon(T_L^4 - T_{\infty}^4)) \dots\dots\dots(2)$$

where : Q = heat lost (kJ)

h = convective heat transfer coefficient (W/m²K)

A = surface area (m²)

T_D = temperature of furnace vertical wall (K)

T_L = temperature of furnace horizontal wall(K)

T_{∞} = ambient temperature (K)

T_f = temperature of the furnace chamber (K)

- ΔT = temperature difference between wall and ambient (K)
- K_u = conductivity of air (W/mk)
- σ = Stefan-boltzman constant : $5,67 \times 10^{-8}$
- ε = emissivity of object

The value of furnace efficiency is the ability to distribute the heat, which can be determined by the following equation (Darmawan, 2003):

$$\eta = \frac{Q_{e1}}{Q_f} \times 100 \% \dots\dots\dots(3)$$

$$Q_e = Q_f - Q_T \dots\dots\dots(4)$$

$$Q_f = m_f \times HHV \dots\dots\dots(5)$$

where:

- Q_T = heat lost total (kJ)
- Q_f = heat energy of combustion of biomass, (kJ)
- m_f = biomass fuel mass burned during combustion, (kg)
- Q_e = furnace efektif energy (kJ)

3. Results and Discussion

3.1. Dimension dan Characteristic of Furnace and Conduit Pipe

Furnace is made of iron. Iron plate was chosen for furnace because of the strength and heat resistant. Furnace was designed as cube with the dimension of 0.35x0.35x0.35 (m) and the thickness of 0.003m. The maximum capacity of the furnace of coconut shell without porosity is 28 kg. When the porosity taking into account of the capacity, the capacity around 7- 12 kg. Conductivity value of furnace varied depending on the temperature of the furnace. The value of the furnace emissivity is 0.61 because of using ferrous materials.

Table 1. Furnace Specification

Materials	Iron (<i>Iron, then rusted red</i>)
Shape	Cube
Side wall (m)	0.35
Thickness (m)	0.003
Capacity (kg)	28
Conductivity (W/m°C)	36-73
Emissivity	0.61

Based on the shape of the furnace, cube, the furnace wall composed by 6 iron wall. The surface area of each wall of the furnace can be seen in Table 2.

Table 2. Surface Area of the Furnace

Furnace Surface Area (m ²)					
Left (A _{L1})	Right (A _{L2})	Front (A _{L3})	Back (A _{L4})	Bottom (A _{L5})	Top (A _{L6})
0.1225	0.1225	0.1172	0.1172	0.1225	0.1225

Based on Table 2, it can be seen that surface area for front and back side walls smaller than the others because on those side wall were hollow.

3.2. Conduit Pipe

Conduit pipe is media to connecting the furnace and the fumigation chamber. The specification of the conduit pipe can be seen in the following table.

Table 3. Specification of Conduit Pipe

Materials	Iron (<i>Iron, then rusted red</i>)
Shape	Cylinder
Length (m)	0.25
Thickness (m)	0.004
Diameter Outer (m)	0.09
Diameter Inner (m)	0.082
Surface Area of the Pipe Wall (m ²)	0.064
Conduktivitiy (W/m°C)	36-73
Emissivity	0.61

Material used in the conduit pipe same with the material for furnace is iron with the emissivity 0.61. The shape of the pipe is cylinder with the length 0.25 m and the thickness 0.004 m. For the conductivity value also same with the furnace conductivity value which is vary depending on the temperature flow. This conduit pipa is not covered by insulator so that the cylinder conduit pipe in direct contact with the air.

3.3. Heat Lost from Furnace

Furnace heat loss occurring in several places, among others, vertical and horizontal side walls, Vertical furnace walls are furnace wall which stand upright. These vertical walls divided into four: left side wall, right side wall, front side wall and rear side wall. While horizontal walls divided into two, top side wall and bottom side wall. Heat loss that occur in the furnace can be seen the Table 4.

Table 4. Heat Loss on Furnace

Heat Loss on Furnace					
Left (Q _{L1})	Right (Q _{L2})	Front (Q _{L3})	Rear (Q _{L4})	Bottom (Q _{L5})	Top (Q _{L6})
839.31 W	810.45 W	691.61 W	852.39 W	920.30 W	775.96 W
1510.76 kJ	1458.81 kJ	1244.91 kJ	1534.30 kJ	1656.55 kJ	1396.72 kJ

Based on Table 4, it can be seen that the greatest heat loss obtained on the bottom wall of the furnace, which is equal to 1656.55 kJ. This occur because the combustion of biomass is in direct contact with the bottom wall, so this condition allowing the heat lost faster than the other side. The smallest heat lost found in the front wall because the position of this wall is a bit far from the biomass combustion. When viewed from the biomass combustion, the smallest heat lost should be from the top side wall, because the distance from the biomass combustion is the biggest. But the heat lost on the top side bigger compare with the front side because the fire produced of biomass combustion blow to the top of the furnace.

3.4. Heat Loss from Conduit Pipe

Heat loss from conduit pipe which is connected furnace and fumigation chamber should be taking into account beside heat loss from furnace walls. The analysis used in the calculation of heat lost from conduit pipe approximated by the similar equation that used for furnace walls. The calculation of heat loss data for conduit pipe can be seen in Table 5.

Table 5. Measurement Data on the Conduit Pipe

Dimension	Value
Temperature of fumigation chamber	321.9
Coefficient of expansion	0.0031
Conduktivty of material (W/m°C)	55
Surface area (m ²)	0.064
Prandtl number	0.703
Grashof number	1.13E+08
Rayleigh number	8.01E+07
Nusselt number	55.82
Convective heat transfer coefficient (W/m°C)	37.95
Resistancy (K/°C)	5.84
Heat transfer coefficient mean (W/°C)	0.17
Emissivity	0.61
Heat Loss (W)	170.93
Heat Lost (kJ)	307.68

Heat loss from conduit pipe smaller compare with the furnace walls which is 307.68 kJ. Based on the result obtained, the conduit pipa effective in inhibiting the heat loss to the environment. This condition occur because the length of the conduit pipe only 0.25 m, so the heat lost from along the conduit pipe can be minimized. Based on the surface area, the lost also small, so the conduit pipe can be distributed heat optimally.

3.5. Efficiency Heating System

The performance of the furnace can be measured by the efficiency of the furnace. The efficiency of this furnace is calculated from the furnace and heating system. The efficiency is calculated by comparing effective energy used with energy given to the system. The value of efficiency of furnace and heating system can be seen in Table 6.

Table 6. Furnace and Heating System Efficiency

Furnace Efficiency (%)	Heating System Efficiency (%)
40.40	38.32

Based on Table 6, it can be seen that the efficiency of furnace 40.40%. The furnace efficiency obtained is quite substantial for a successful energy channeled into conduit pipe for almost half of energy biomass combustion. Energy that can be supplied to the conduit pipe is 5967.708 kJ of 14769.75 kJ that produced by biomass. The furnace can be said to be efficient because the heat energy generated is large enough because most of the furnace operates with relatively low efficiency (about 7%) compared with other combustion appliances . Factor which caused quite high efficiency is due to the use of not fullcapacity of the biomass in the furnace. The difference between heating system and furnace isthat the heating system is a set of apparatus which used to channel the smoke produced fromfurnace. Heating system consist of furnace, blower, conduit pipe for air and smoke. Heatingsystem efficiency that calculated in this study is the combination of smoke conduit pipe and furnace. Based on Table 6, heating system efficiency is 38.32 %. This signifies that energy goes to fumigation chamber big enough for 5660.03 kJ.

4. Conclusion

Based on the results and discussion, a number of conclusions are as follows:

1. The furnace and conduit pipe is made of metal with conductivity 73 W/m°C and emissivity 0.61.
2. The biggest heat loss is in the bottom wall of the furnace of 1656.55 kJ.
3. Heat loss in the conduit pipe of 307.68 kJ.

4. Furnace efficiency and heating system of 40,40% and 38.32% respectively.

Suggestion

From the results, discussion and the conclusions, it is advisable to conduct further by modification the furnace to reduce the heat loss from the heating system.

References

- [1] Abolagba OJ and Igbinevbo EE. 2010. *Microbial load of fresh and smoked fish marketed in Benin metropolis Nigeria*. Journal of Fisheries and Hydrobiology 5(2):99-104.
- [2] Bower CK, Hietala KA, Oliveira ACM, and Wu TH. 2009. *Stabilizing oils from smoked pink salmon (Oncorhynchus gorbuscha)*. Journal of Food Science 74(3):248-257.
- [3] Darmawan, Dian. 2003. Uji Kinerja Alat Pengering Tipe Efek Rumah Kaca Dengan Energi Surya dan Tungku Biomassa Sebagai Sistem Pemanas Tambahan Untuk Proses Pengeringan. Bogor : Institut Pertanian Bogor.
- [4] Holman, J.P.. 1981. Heat Transfer 10 th ed. Ney York : McGraw-Hill.
- [5] Kumolu-Johnson CA, Aladetohun NF, and Ndimele PE. 2010. *The effect of smoking on the nutritional qualities and shelf-life of Clarias gariepinus (Burchell 1822)*. African Journal of Biotechnology 9(1):073-076.
- [6] Keating, Eugene L. 2007. Applied Combustion 2nd ed. US : Taylor & Francid Group.

Design of Seismic Recorder with Single-Axis Geophone for Passive Seismic Monitoring

I Wayan Sudiarta^{1,*}, Raja Fathurrahman Akmaludin¹, Dian Wijaya Kurniawidi¹, Made Sutha Yadnya²

¹*Physics Study Program, Faculty of Mathematic and Nature Sciences, the University of Mataram Mataram, NTB, Indonesia*

²*Department of Electrical Engineering, Faculty of Engineering, the University of Mataram, Mataram, NTB Indonesia*

* Email: wayan.sudiarta@unram.ac.id

Abstract

Seismic events such as earthquakes have influenced our life. To monitor seismic events requires a seismic recorder that consists of five parts : (1) a single axis geophone with natural frequency of 1 Hz, (2) a signal conditioning circuit, (3) an ADC circuit, (4) an RTC circuit and (5) an SD logger circuit. Simple test have shown that our seismic recorder can record seismic waves up to 70 samples per second, and with amplification of 1400 times. Seismic monitoring for two weeks in the City of Mataram have shown that seismic waves are clearly shown and produced by human activities during the night and the day, and natural phenomena such as earthquakes. Analysis of P and S waves of two earthquakes that happened during time of the seismic monitoring have shown that the distance of the epicenters of the earthquakes are obtained to be in agreement with epicenters provided by the Indonesian Agency for Meteorology, Climatology and Geophysics (BMKG).

Keywords: *Seismic recorder, Single-axis geophone*

1 Introduction

Seismic waves in the earth crust are, for examples produced by the movement of tectonic plates, human activities, tides and winds. Characteristics of seismic waves can be used to determine subsurface structure of the earth. One can use active seismic sources (known as the active seismic method) and natural seismic sources (the passive seismic method) [4]. To record natural seismic vibrations, a passive seismic recorder is needed. The conventional seismograph which used is a seismograph with short-time records, its only capable to short-term record. The main purpose of this study is to produce a device with single-axis geophones that is capable of recording natural seismic activities for a long period of time [1], it is low cost and low power device. This device is then applied to record seismic waves in the City of Mataram.

2 Related Work

Study on a design of the device for the detection of passive seismic phenomena such as earthquakes was conducted by Zhang [8] for a design geophone to detect an earthquake using MEMS. Application for monitoring volcanic activity with wireless sensor network (WSN) was done by Werner-Allen et. al [6]. A study to determine locations of hydrocarbon was also conducted by Mohammed [3].

3 Hardware Design

The seismic recorder consists of a single axis geophone LF-24, a signal conditioning

circuit (see Fig. 1 (a)), Data logger shield, an Arduino Mega, an ADC circuit ADS 1115.

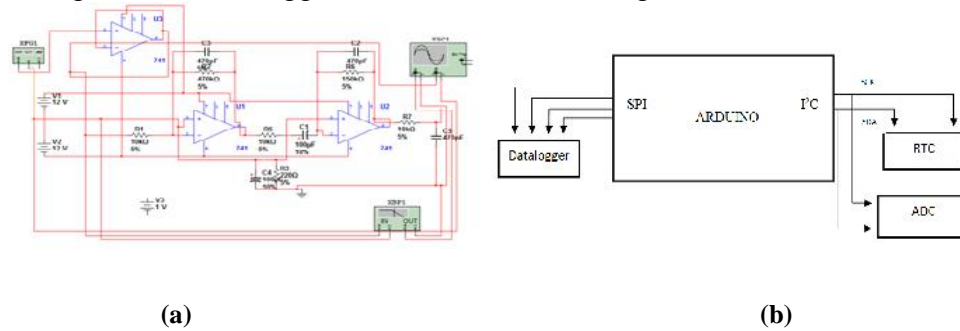

Figure 1. Single-axis system (a) signal conditioning circuit for the seismic recorder (b) conceptual diagram system

3.1 Single-axis Geophone System Design

The design of signal conditioning using operational amplifier with active filter system and strengthening, besides signals conditioning are also converted signal using a ADC ADS1115 with 16 bit resolution. The design of the signal conditioning can be seen from Figure 1 (a) with reinforcement cascade and band-pass filter [2]. Then for the system design and system timer recording (see Fig. 1 (b)) using the data logger shield with the type of communication with arduino using SPI for recording system and I²C timer system.

3.2 System Testing and Data Retrieval

System testing is done to determine whether the system is designed to work in accordance with the draft, testing of the system consists of laboratory testing. The analysis procedure for recording data on a long-term passive seismic activity starting from obtained data recording for one week, data generated some files that are the result of recording per hour for one week, and then merge the files according to the recording time. Results of one week of data is then processed using Matlab with STFT methods to see the difference frequencies occur at any time. Then, with the data STFT characterization was carried out to see phenomena that occur during recording [5].

4 Results and Discussion

Results single-axis system design geophone can be seen in Figure 2 (a) consists of signal conditioning, system timer and recording system.

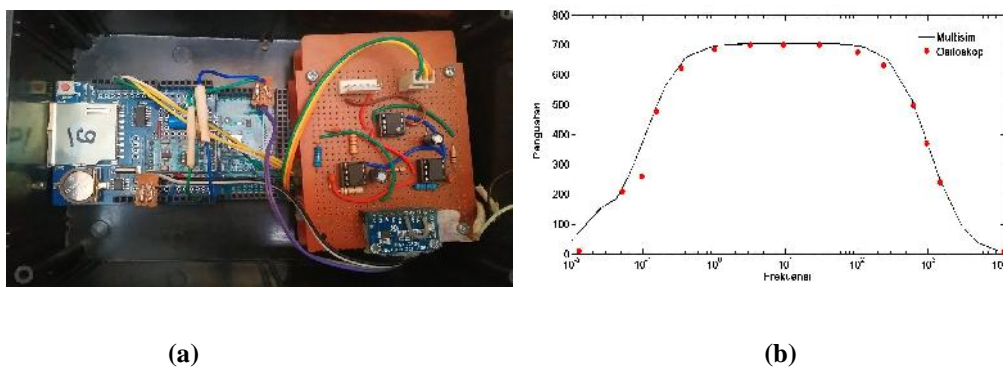

Figure 2 System results (a) Single-axis geophone design result (b) bode diagram result

Signal conditioning consists of active filter, amplifier and ADC, timer and recording system designed using data logger module shield and Arduino as the controller system. The results of the design to produce systems that are capable of storing and managing time digital. The results of the input signal conditioning to arduino then processed and determined when the signal came by RTC and recording systems store data signal recording and time data from

the RTC and then storing them in SD-card.

4.1 Design Testing Result

System testing is done on a laboratory scale and outside testing, the purpose of this test is that the designed system capable of recording seismic waves passive. Single-axis system testing geophone testing laboratory scale to the signal conditioning, ADC, timer systems and recording systems. Testing signal conditioning bode diagram band pass filter using multisim with cut-off frequencies between 0.345 Hz and 270.081 Hz and gain 706.042 times. The results obtained from the program multisim compared with the results of measurements with the oscilloscope showed in Figure 2 (b), the results were very close to the simulation results with multisim with cut-off frequency of 0,351 Hz - 240.08 Hz.

4.2 Long term record Result

Long-period recording seismic activity aims to record human activity and activity within one week, Figure 3 is a spectrogram of recording results for one week.

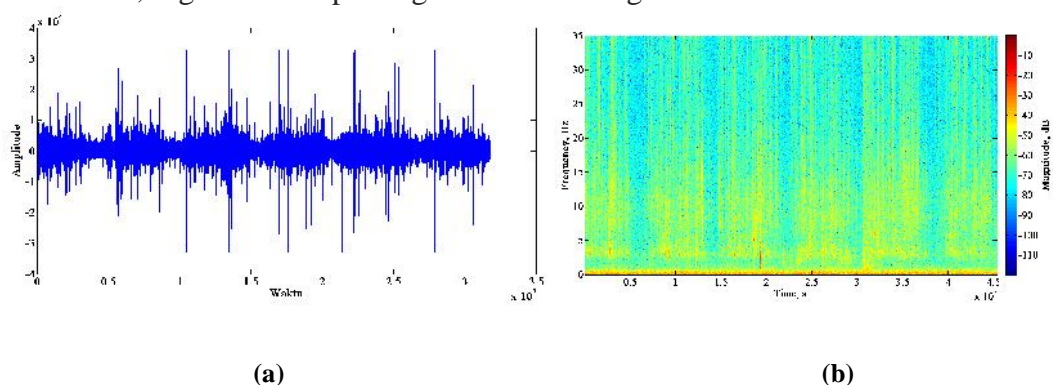

Figure 3 Long-term record results (a) one week record signal results (b) one week record spectrogram results

Long-term passive seismic recording there are several phenomena such as earthquakes recorded, the activity of motor vehicle traffic and activities in the morning and evening. Figure 4 (a) and Figure 5 (a) shows the phenomenon of earthquakes and the time recorded on Thursday 9 June 2016 at 10:41 wita and 12:13 wita, it corresponds to the time recorded by BMKG time of occurrence of the phenomenon of earthquakes.

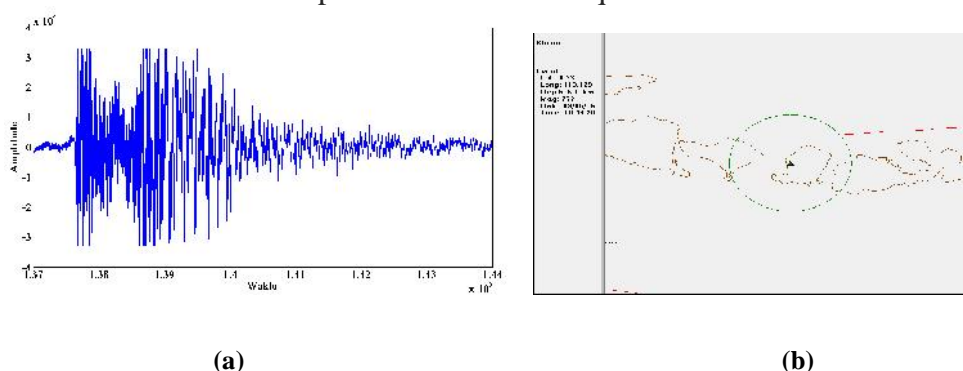

Figure 4 Earthquake event (a) earthquake record at 10:41 wita (b) Epicenter result for earthquake record at 10:41 wita

Results picking seismic wave in Figure 4 (a) was difference in arrival time for the P and S waves which is 12 seconds, to determine the distance of the epicenter resulting from the earthquake epicenter distance [7] is 100.8 Km (see Fig. 4 (b)) from geophone.

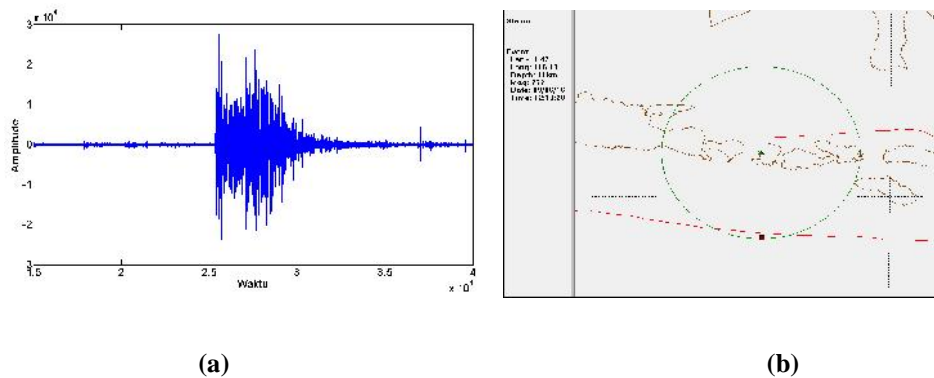

Figure 5 Earthquake event (a) earthquake record at 12:13 wita (b) Epicenter result for earthquake record at 12:13 wita

The quake, which occurred at 12:13 wita showed great magnitude so as to obtain arrival time differences for P and S waves are used digital filter to smooth the result of the recording of Figure 5 (a) is obtained wave arrival time difference of 39 seconds obtained epicenter of the earthquake [7] is 327.6 Km (see Fig. 5 (b)) from geophone.

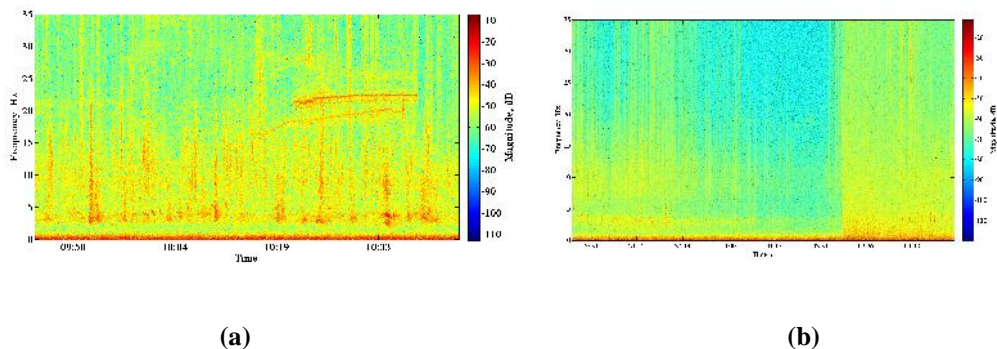

Figure 6 Human Activity (a) human activity spectrogram results (b) human activity in day and evening results

Seismic activity caused by humans in general can be seen in Figure 6 (b) it's at 03:00 wita humans activity started, this is indicated by an increase in magnitude at all frequencies recorded. Human activity is a motor vehicle passing near the geophone can be shown in Figure 16, where the horizontal red line at a frequency of 20Hz - 23Hz, it is repeated every day at 10:00 wita to 11:00 wita and 04:00 wita. to 18:00 wita.

5 Conclusions and Future Work

Based on the result of design and recording Single-axis geophones, it can be concluded that design and testing single-axis geophone can perform passive seismic activity with frequency between 0.325 Hz and 270,364 Hz, gain by 1400 and sampling record 70 Hz and recording long-term passive seismic activity obtained natural phenomena such as earthquakes with epicenter distance 100.8 Km and 361,2 Km, also record human activity.

For development single-axis geophone system is necessary to improve its system in higher and faster data processing using raspberry pi, high-resolutions ADC 24-bit and IOT-based to facilitate data recording, also apply to volcano monitoring and measure the building motions.

References

- [1] Bowness, D and Lock, A C., 2007, Monitoring the Dynamic Displacement of Railway Track., *proceeding of the institution of mechanical engineers, part F : journal of rail and rapid transit*

- [2] Haskov, J and Gerard . W., 2004. *Instrumentations In Earthquake Seismology*. Springer : Dordrecht, Netherlands.
- [3] Mohammed, Y, 2009 . *Low-frequency passive seismic experiments in Abu Dhabi, United Arab Emirates: implications for hydrocarbon detection*. The Petroleum Institute. UEA.
- [4] Sheriff, R. E., and Geldart, L. P., 1995. *Exploration Seismology 2nd Edition*. Cambridge University Press: New York. USA.
- [5] Walker, D. 2008, *Recent developments in low frequency spectral analysis of passive seismic data*. First break, 26, 67-77.
- [6] Werner-Allen, G. Johnson, J. Ruiz, M. Lees, J. Welsh M., 2005 ,Monitoring volcanic eruptions with a wireless *sensor network*, *Wireless Sensor Networks, Second European Workshop*, Harvard University., Boston, MA, USA.
- [7] Wood, M. M. (2007, April 16). *UPseis*. Retrieved June 5, 2016, from Michigan Tech: <http://www.geo.mtu.edu/UPSeis/locating.html>.
- [8] Zhang Xiaodan, Ke Xizheng, Zhang Zhiyu, 2010, Research on Micro-Electro-Mechanical-Systems digital geophone, *International Conference on Artificial Intelligence and Computational Intelligence*, Beijing, China.

Zinc Supply and Root Pruning on Growth and Relative Zinc Absorption Rate by Transplanted Rice (*Oryza sativa* L.)

Mulyati

*Department of Soil Science, Faculty of Agriculture, University of Mataram
Jalan Pendidikan 37 Mataram 83125 Lombok. Telp. 0370621435
Email : felicia2810@gmail.com*

Abstract

Zn deficiency is associated with the seedlings development growth stage. Therefore, rice seedlings appear to be sensitive to Zn deficiency after transplanting into flooded soil. The purposes of the present study were to investigate the effect of Zn application and root pruning on growth and Zn absorption by transplanted rice. Pots were arranged in a factorial complete randomized design with three replicates, which comprised of 7 rates of Zn (0, 20, 40, 80, 160, 320 and 640 $\mu\text{g Zn kg}^{-1}$ air dry soil), with 0 and 50 % of root pruning. The obtained data were analysed statistically by using the analysis of variance. The results showed that the relative Zn absorption rate were closely related to the dry weight of shoot and root. Root pruning had a lower rates of Zn absorption than those of without pruning. Therefore, root pruning impaired plants growth and eventually reduced dry matter production. In conclusion, root recovery and root function of transplanted rice were sluggish by low Zn supply and root pruning, and increasing Zn application could not compensate for the pruned roots.

Keywords : *Zinc, root pruning, absorption, transplanted rice.*

1. Introduction

Zinc (Zn) deficiency is recognized as one of the most widespread soil constrain in rice production (Sillanpää, 1990). Nutritional disorder of rice associated with micronutrients have escalated as modern technology for rice production has been applied. These include increase crop requirements on the soil's ability to supply Zn, use of urea and phosphate fertilizers which the resulting of P – induced Zn deficiency (Srivastava *et al.*, 1999). Recent research shows that micronutrients particularly Zn have an important role in root stress (Welch, 1995). Marschner (1993) reviewed that plant roots may also influence the availability and uptake of mineral nutrients by releasing of root exudates, which induce changes in the rhizosphere. The rhizosphere modification of rice roots may be as the important factor in decreasing the concentration and mobility of Zn in the flooded soil.

Zinc deficiency mostly occurs in flooded rice, because flooded soil causes drastic change in the chemical and biological reaction in the soil (Turner & Patrick, 1986). It could be related to the chemical properties of flooded soil which decrease Zn availability and also attributed to the inefficient Zn absorption of transplanted rice seedlings. When soil is flooded, the concentration of most nutrients such as phosphorus (P) in the soil solution increases but it decrease in Zn availability (Tandano & Yoshida, 1978).

Generally, Zn deficiency is associated with the seedlings development stage of growth at 15 to 20 days after seedlings emergence (Wells *et al.*, 1993). Therefore, rice seedlings appear to be sensitive to Zn deficiency after transplanting into flooded soil. Flooded soil reduces most of plants growth by affecting physiological processes such as decrease in absorption and transport ions through roots. It may cause plants suffer from

nutrient deficiency, because translocation of the nutrients from roots to the shoots is often restricted by lack of aeration (Huang *et al.*, 1995). Zinc deficiency can be corrected by applying Zn compounds to the soil or transplanted wetland rice seedlings for further growth especially in the critical early growth stage (Quijano-Guerta *et al.*, 2002). A small amount of Zn apply to the nursery may be feasible, effective and efficient for uptake nutrients (Reyes & Brinkman, 1968).

Seedlings are pulled up from the nursery without regard to the amount of roots that are retained on each plant (Grist, 1975). In addition, Jack (1923) cited Grist (1975) stated that the physiological factors involved in transplanting are obscure, the damage of the root system at transplanting or root pruning would stimulate the plant growth and. The mechanisms of rice growing in flooded soil after transplanting and their nutrients absorption especially for Zn is poorly understood. Therefore, it is worthy to investigate the effect of Zn supply and root pruning on the growth of transplanted rice relate to the relative Zn absorption rate, in order to overcome the recovery of root function.

The purposes of the present study were to investigate the effect of Zn application and root pruning on the vegetative growth stage of transplanted rice; and also to determine the relative Zn absorption rate by transplanted rice with 50 % root had been pruned and without pruning.

2. Materials and Methods

Treatment. A pot experiment conducted in a trace-element glasshouse. Rice seedlings treated with seven rates of Zn supplied as $\text{ZnSO}_4 \cdot 7\text{H}_2\text{O}$, respectively : 0, 20, 40, 80, 160, 320 and 640 $\mu\text{g Zn kg}^{-1}$ air dry soil, and root pruning (0% pruning or without pruning and 50% of root pruning). Each treatment combination comprised of three replications. Pots were arranged in a Factorial Randomized Block Design.

Seedling growth. The rice cultivar (cv) was used IR-36 Rice seeds dormancy was broken by heating seeds at 35 °C for 24 hours. Seeds were placed for 48 hours on brown filter paper moistened with 1 mM CaSO_4 and 10 $\mu\text{M H}_3\text{BO}_3$ solution at room temperature to initiate germination. Seeds were sown in a seedbed by using sand culture. Before sowing, the sand were rinsed in DDI water. Complete nutrients were applied into the seedbed soil including 50 $\mu\text{g Zn kg}^{-1}$ air dry soil to provide adequate nutrients for seedling growth. Rice seeds were raised in a seedbeds for 24 days before being transplanted into Zn treated soils.

Plant culture. Representative soil were collected from the field on 0-20 cm depth. Air dried soil were sieved through a stainless steel screen (4x4 mm) and mixed, then placed in 5 kg portions of air dry soil the plastic bags fitted inside plastic pots. All treatments were receive basal nutrients as follow : 174 K_2SO_4 , 98 $\text{CaCl}_2 \cdot 2\text{H}_2\text{O}$, 93 NH_4NO_3 , 90.7 KH_2PO_4 , 24.6 $\text{MgSO}_4 \cdot 7\text{H}_2\text{O}$, 8.5 $\text{MnSO}_4 \cdot 7\text{H}_2\text{O}$, 1.3 $\text{CuSO}_4 \cdot 5\text{H}_2\text{O}$ 0.85 H_3BO_3 , and 0.4 $\text{NaMoO}_4 \cdot 2\text{H}_2\text{O}$ mg kg^{-1} air dry soil. The macronutrients were purified to remove Zn by using dithizone in chloroform at pH 6.5 to 7.5 (Hewitt, 1966). The nutrient solutions were added to the soil and mixed thoroughly, then watered until flooded to 3-5 cm above the level of the soil surface. Soil in each pot was paddled for 2 weeks before transplanting.

Six selected seedlings were transplanted into each pot. At 7 days after transplanting (DAT), seedlings were thinned to 3 plants per pot. Seedlings sampled at thinning were weight for fresh and dry weight, and also used for Zn determination. Transplanting were done gently, then carefully pull away for one by one plant. The soil was maintained at flooded condition (3-5 cm) throughout the experiment with double deioned water (DDI) water, every week 280 NH_4NO_3 mgkg^{-1} were applied to each pot. Pots were maintained in temperature controlled water baths at 28 - 30 °C.

Harvest procedure. Rice seedlings growth was measured 30 DAT. Plants were cut at ground level (1 cm from the soil surface) as shoot and root samples were washed carefully to remove soil with DDI water. Fresh and dry weight of shoots and roots were recorded.

After that, all plant samples were oven dried at 65-70 °C until constant weight achieved. Root length was measured by using Comair root length scanner (Newman, 1966).

Plants and soil analysis. The plant samples were milled for analysis. Zinc concentration was determined after digesting samples in concentrated HNO₃ at 135-140 °C by using an inductively couple plasma - optical emission spectrometry (ICP-OES) (Zarcinas *et al.*, 1987).

Data analysis. Collected data from the experiment were analysed statistically by using analysis of variance, When F-values were significant at P < 0.05, means comparison among treatments were compared by employing Fisher's least significant difference.

3. Results and Discussion

3.1. Zinc Responses on the Growth

These visible symptoms of Zn deficiency observed at 12 days after transplanting, with absence of Zn and low Zn supply (20 µg Zn kg⁻¹ soil), and mild symptoms at 40 also µg Zn kg⁻¹ soil. It occurred both in plant with root had been pruned or root damaged and without pruning or intact root system. Zn deficiency symptoms marked by yellowing and had brown spot on the young and old leaf blades. Young leaves became chlorotic, bronzing of the leaves, internodes short, plants became dwarf, produced few tillers and new leaves were formed smaller than plants supplied with adequate Zn, plants growth were retarded. As a result, plants produced lower root and shoot dry matter. While, plants supplied with 80 µg Zn kg⁻¹ soil or higher did not show any of visible sign of Zn deficiency symptoms.

Shoot and root dry matter production responded positively (P < 0.05) by Zn application and root pruning, no interactive effect was found between Zn supply and root pruning (Table 1). Without Zn supply and low Zn supply and combination with 50 % root pruning were strongly depressed shoot dry weight. Root dry matter responded to increasing Zn supply in similar way to shoot dry matter.

The maximum shoot dry matter was obtained at 40 µg Zn kg⁻¹ soil, and at 40 to 160 µg Zn kg⁻¹ soil shoot dry matter exhibited a plateau, and no significant difference was found between 160 and 640 µg Zn kg⁻¹ soil. Indeed, raising Zn supply from 40 to 640 µg Zn kg⁻¹ soil had no significant effect on the shoot growth Thus, this suggests that rice plant had a lower functional requirement of Zn for the growth and development. In addition, root pruning resulted in reduced the dry matter production, and increasing of Zn application could not compensate for the pruned root (Bar-Tal *et al.*, 1994).

Table 1. Effect of zinc supply and root pruning on shoot dry weights (g plant⁻¹) of rice cv. IR-36 at 15 and 30 days after transplanting.

Treatment		Dry weights (g plant ⁻¹)	
Zinc level (µg kg ⁻¹)	Root pruning (%)	Shoot	Root
0	0	2.20 ± 0.22	1.17 ± 0.03
	50	2.10 ± 0.20	0.81 ± 0.09
20	0	2.91 ± 0.06	1.19 ± 0.03
	50	2.77 ± 0.30	0.93 ± 0.07
40	0	3.03 ± 0.26	1.23 ± 0.09
	50	3.01 ± 0.11	0.96 ± 0.04
80	0	3.12 ± 0.10	1.24 ± 0.18
	50	3.10 ± 0.04	0.97 ± 0.03
160	0	3.26 ± 0.04	1.27 ± 0.19
	50	3.25 ± 0.13	0.98 ± 0.06
320	0	3.29 ± 0.16	1.29 ± 0.10
	50	3.21 ± 0.12	1.00 ± 0.09

640	0	3.37 ± 0.03	1.31 ± 0.07
	50	3.20 ± 0.05	1.02 ± 0.07

Values are means of three replicates ± SE.

Root dry matter production increased progressively by Zn supply and root pruning. Zinc supply from 0 to 20 µg Zn kg⁻¹ did not increase root dry matter production. The maximum root dry matter was attained at 80 µg Zn kg⁻¹ soil. Thus, shoot growth of transplanted rice required a higher external Zn requirement compared with root growth. This result was similar to previous study on transplanted oilseed rape (Mulyati, 2004). Root growth and development are characterised by a complex interaction between roots and shoots, and between roots and the environment (Marschner, 1993). These study indicated that the maximum shoot growth required a higher external Zn supply compared with root growth. At the early growth stage, root and shoot growth required the same level of Zn supply.

Plants with low Zn added and without Zn added were significantly depressed root and shoot dry matter both in root had been pruned and without root had been pruned. These result confirmed that the higher external Zn requirement for transplanted rice is due to the requirement for shoot growth rather than root growth. It has been well accepted that root system such as root diameter, volume and length are crucial factors in determining plant growth and crop yield through nutrients uptake and water (Morita & Abe, 1996; Yamauchi *et al.*, 1996). Increasing Zn supply and 50 % root pruning had a significant effect on shoot : root ratio (Figure 1). For adequate Zn supply and high Zn supply shoot : root ratio tended to be stable or consistent. The removal of 50 % roots produced higher shoot : root ratio than that of plants with root had not been pruned. It apparent that root pruning

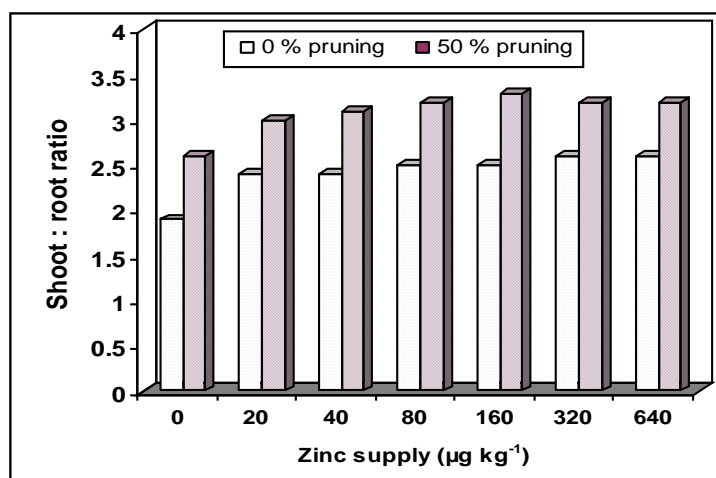

Figure 1. Effect of zinc supply and root pruning on shoot : root ratio of transplanted rice at harvest days.

would have removed a significant portion of root absorbing surface, leading to the increased of external Zn requirement for Zn absorption during the post-transplanting period before the full recovery of root function. Thus, the damage of root system of transplanted rice required a period of time for the root recovery to re-establish a favourable shoot : root ratio. Plants with root had been pruned decreased with time, but plants with root had not been pruned were almost un-change, except for low Zn supply or between 20 and 40 µg Zn kg⁻¹ and without Zn added. Plant with root damaged had higher shoot : root ratio than those of intact root system. The shoot : root ratio induced by root pruning led to impaired the recovery of root function required higher external Zn requirement.

3.2. Root length development

Increasing Zn supply from 0 to 80 $\mu\text{g Zn kg}^{-1}$ soil increased ($P = 0.05$) root length by 10 % at the harvest day or 30 days after transplanting. There was a significant interaction between Zn supply and root pruning (Table 2). Plants with root had not pruned showed a greater ($P = 0.05$) root length development about 15% than plants with root have not been pruned. From this observation, it appeared that shoot growth was more correlated with the response of root length. As for shoot dry weight, the maximum root length also required a higher external Zn requirement compared with root dry matter, the greater the root length development the larger shoot dry matter were obtained. These observation was consistent with the result reported by Yamazaki (1991) on the root system of rice which is constitute by their root morphology such as diameter, length and branching.

3.3. Relative Zn absorption rate

Rate of Zn absorption per unit root fresh weight generally increased with increases in the external Zn supply both with root had been pruned or had not been pruned, but no interactive was found between the treatment (Table 3). The relative Zn absorption rate in

Table 2. Effect of zinc supply and root pruning on the root length development of transplanted rice

Treatment		Root length
Zinc level ($\mu\text{g kg}^{-1}$)	Root pruning (%)	(m plant ⁻¹)
0	0	4.7±0.1
	50	1.2±0.2
20	0	6.3±0.1
	50	4.6±0.1
40	0	7.4±0.1
	50	6.4±0.3
60	0	8.5±0.1
	50	6.9±0.2
80	0	9.6±0.1
	50	7.4±0.2
160	0	9.2±0.2
	50	8.0±0.1
320	0	9.1±0.2
	50	8.4±0.2

Values are means of three replicates \pm SE.

Plants with root had been pruned were slightly higher than plants with intact root systems. Increasing Zn supply from 0 to 40 $\mu\text{g Zn kg}^{-1}$ soil increased rates of Zn absorption, in addition, increase Zn supply from 40 to 640 $\mu\text{g Zn kg}^{-1}$ tended to increase Zn absorption rates but decreased the effectiveness. These means the average of relative Zn absorption tended to remain constant over the four weeks successive weeks of growth period. The dry matter production and yield would not simply determined by the quantity of root, but also influence by the morphological aspect and physiological function of root such as the efficiency of root to absorb water and nutrient from soil (Barber and Silberbush, 1984 ; Iwama & Yamaguchi 1996).

Notwithstanding, there has rarely been study focus on the optimum size of root required to maximise dry matter production with adequate absorption of water and nutrients particularly Zn. The effect of root pruning has been reviewed by Geisler and Ferree (1984),

they reported that root pruning reduced vegetative growth in a number of plant species such as apple. The removal of 50 % the root system will lower the growth rate of the shoot, and change in the availability of photosynthesis products, consequently the decline of photosynthesis product led to decreased of shoot and root weights.

Table 3. Effect of zinc supply and root pruning on relative zinc absorption rate in shoot and root ($\mu\text{g plant}^{-1}$) of transplanted rice.

Treatment		Shoot	Root
Zinc level ($\mu\text{g kg}^{-1}$)	Root pruning (%)	($\mu\text{g plant}^{-1}$)	($\mu\text{g plant}^{-1}$)
0	0	32.9±2.2	15.4±1.4
	50	25.1±2.2	9.3± 0.5
20	0	53.4±1.2	18.2±2.2
	50	36.3±2.3	13.9±0.2
40	0	64.2±3.7	22.7±0.9
	50	52.5±1.3	15.6±0.3
80	0	79.5±2.4	25.4±2.1
	50	74.3±5.7	17.0±0.1
160	0	107.8±2.8	30.4±1.4
	50	88.9±3.7	18.1±0.2
320	0	134.0±4.0	35.5±0.1
	50	78.3±2.9	25.4±0.1
640	0	125.6±1.4	36.7±1.7
	50	114.2±2.6	35.4±1.6

Values are means of three replicates \pm SE.

Indeed, post-transplanting growth of rice may vary with the period time for the root recovery phase, which influence with the environmental factors condition such as soil pH, soil temperature, soil water, waterlogging, nutrient availability and also plant factors including nutrients status of the seedling and seedling vigour.

4. Conclusions

This study has shown that transplanted rice required external Zn requirement not only for the root growth, but also for the shoot growth and root length development. Apparently, root pruning impaired growth rates and eventually reduced shoot and root dry matter production. Plant with 50 % root had been pruned reduced the shoots and roots of dry matter of transplanted rice, which decreased the relative Zn absorption rate. It can be concluded that root recovery and root function of transplanted rice were sluggish by low Zn supply and root pruning.

These results suggest that Zn supply should be applied to the nurseries, in order to obtain the vigorous seedlings to enhance the earlier establishment in the main-field ; and need to be explored further by studying the mechanism of root recovery of transplanted rice or by different plant species.

References

- [1] Barber, S.A. and M. Silberbush. 1984. Plant root morphology and nutrient uptake. *In* Root, Nutrient and Water Influx, and Plant Growth. Eds. S.A. Barber and D.R. Bouldin. *Amer. Soc. Agron.* 49: 65-87.
- [2] Bar-Tal, A., A. Feigin, I. Rylski, and E. Pressman. 1994. Effect of root pruning and N-NO₃ solution concentration on nutrient uptake and transpiration of tomato plants. *Scientia Horticulturae* 58 : 77-90.
- [3] Geisler, D. and D.C. Ferree. 1984. The influence of root pruning on water relations, net photosynthesis, and growth of young 'Golden Delicious' apple trees. *J. Amer. Soc. Hort. Sci.* 109 (6): 827-831.
- [4] Grist, D.H. 1975. Rice. Fifth edition. *Whitstable Litho Ltd.* Kent.
- [5] Huang, B., J.W. Johnson, D.S. NcSmith and D.C. Bridges. 1995. Nutrient accumulation and distribution of wheat genotypes in response to waterlogging and nutrient supply. *Plant and Soil.* 173 : 47-54.
- [6] Iwama, K. and J. Yamaguchi. 1996. Difference in root system development among crop species and genotypes. *In* Root and Nitrogen in Cropping Systems of the Semi-Arid Tropics. Eds. O. Ito, K. Katayama, C. Johansen, J.V.D.K. Kumar Rao, J.J. Adu-Gyamfi and T.J. Rego. *Japan International Research Center for Agricultural Science (JIRCAS)*. No. 3 :173-184.
- [7] Marschner, H. 1993. Zinc uptake from soils. pp. 59-77. *In* *Zinc in Soil and Plants*. A.D. Robson (Ed). Kluwer Academic Publishers. London.
- [8] Morita, S. and J. Abe. 1996. Development of root systems in wheat and rice. *In* Root and Nitrogen in Cropping Systems of the Semi-Arid Tropics. O. Ito, K. Katayama, C. Johansen, J.V.D.K. Kumar-Rao, J.J. Adu-Gyamfi and T.J. Rego (Eds.). *Japan International Research Center for Agricultural Science (JIRCAS)*. No. 3: 185 -209.
- [9] Mulyati, 2004. Zinc requirements of transplanted oilseed rape. Ph.D Thesis. Murdoch University. WA. Australia.
- [10] Newman, E.I. 1966. Method of estimating the total length of root in a sample. *J. Appl. Ecol.* 3: 139-145.
- [11] Quijano-Guerta, C., G.J.D. Kirk, A.M. Portugal, V.I. Bartolome and G.C. McLaren. 2002. Tolerance of rice germplasm to zinc deficiency. *Field Crop Research.* 76: 123 – 130. Elsevier.
- [12] Rayes, R.Y. and R. Brinkman. 1968. Some methods to minimize zinc deficiency in transplanted wetland rice. *IRRI*. Manila. Philippines. pp. 646-655.
- [13] Sillanpää, M. 1990. Micronutrients assessment at the country level: An International Study. FAO Soils Bulletin. No. 63. Food and Agricultural Organization of the United Nation. Rome. Italy.
- [14] Srivastava, P.C., M.S. Gangwar and V. P. Singh. 1999. Adsorption-desorption of zinc in Mollisols and their relationship with uptake of fertilizer-applied zinc by rice. *Commun. Soil Sci. Plant Anal.* 30(3 & 4) : 471-481.
- [15] Tadano, T. and S. Yoshida. 1978. Chemical changes in submerged soils and their effects on rice growth. *In* *Soil and Rice*. Ed. International Rice Research Institute. pp 399-420. *International Rice Research Institute*, Los Banos, Philippines.
- [16] Turner, F.T. and W. H. Patrick. 1986. Chemical changes in waterlogged soils as result of oxygen depletion. *9 th. International Congres of Soil Science*. Adelaide. Australia.
- [17] Welch, R.M. 1995. Micronutrient nutrition of plants. *In* *Critical Review in Plant Science*. 14(1): 49-82.
- [18] Wells, B. R., B.A. Hueyand and R. J. Norman. 1993. Rice. *In* Nutrient Deficiencies and Toxicities. pp. 15-19. W. F. Bennett (Ed.). *The Am. Phyto. Soc. APS Press*. St.Paul, Minnesota.USA.

- [19] Yamauchi, A., J.R. Pardales and Y. Kono. 1996. Root system structure and its relation to stress tolerance. In Root and Nitrogen in Cropping Systems of the Semi-Arid Tropics. O. Ito, K. Katayama, C. Johansen, J.V.D.K. Kumar Rao, J.J. Adu-Gyamfi and T.J. Rego (Eds.). *Japan International Research Center for Agricultural Science (JIRCAS)*. No. 3 : 211-233.
- [20] Zarcinas, B A., B. Cartwright and L R Spouncer. 1987. Nitric acid digestion and multielement analysis of plant material by inductively couple plasma spectrometry. *Comm. Soil Sci. Plant Analysis*. 18: 131-146.

Making Learning Media of Statistical Physics Course Using The Internet Offline Browser for Physics Students in PMIPA FKIP of Mataram University

Muhammad Taufik¹, Aris Doyan¹, Susilawati¹, Gunawan¹

¹ Study Program of Physics Education, Department of Mathematics and Natural Sciences, Faculty of Teachers Training and Education, Mataram University

Abstract

Statistical physics nowadays is more attractive and has a broad application area, not merely as a bridge thermodynamics to better understanding of the microscopic world, more so even statistical physics can also be applied in the world economy such as the stock market. It's hopeful for students to master and love statistical physics and we realize the necessity of preparing learning media which is effective and efficient in terms of both cost and time. This research is motivated by the lack of statistical physics learning resources in Indonesian language both print and online versions, especially for the needs of prospective physics students in the department of mathematics and natural sciences FKIP Unram. Though the outlook is very bright and statistical physics is the study of physics field which to date continues to grow. Many new things emerge from statistical physics research. Very unfortunate if students in learning activities cannot access this information to the maximum due to lack of resources, especially in Indonesian language. On the other hand, a lot of Results of study is the availability of statistical physics learning media that written in Indonesian language which can be accessed online and offline. For online, we develop website using geogle sites while offline browsing, we choose HTTrack software.

Keywords : *Learning Media, Statistical Physics, offline browsing*

1. Introduction

Statistical physics course is one of the subjects that must be followed by all students majoring in physics education in department of mathematics and natural sciences at faculty of teachers training and education of Mataram University. This course weighs 3 credits. For more than ten years of support this course, we find that statistical physics courses until now a part difficult to learn, especially for most students. This is because the content of the discussion in statistical physics requires an understanding not require a high level of mathematical ability is also high. Plus, the ability of English students who are still not standard, so it is very difficult to understand the concepts of statistical physics is a lot written in English. It is actually not that hard to be something that is difficult for students. In terms of content, it is recognized that the way of understanding of statistical physics is different from other subjects such as wave physics, thermodynamics and mechanics. It needs Intact and integrated knowledge of several other studies should be completely embedded in students. Directly related to success in understanding statistical physics, students must already have a strong foundation in mathematical physics, thermodynamics, classical mechanics, quantum mechanics and solid The lack of resources in Indonesian language literature both print and online versions, coupled with a lack of prerequisite knowledge lead to difficult students learn and capture the full meaning and benefits of studying statistical physics. The use of web-based media which is written in Indonesian language as a companion in the learning process is increasingly needed to cope with the problems that arise because of the limitations of time,

space, and other amenities.

2. The Theoretical Side

2.1. Statistical Physics

Statistical physics is a branch of physics that uses methods of probability theory and statistics, and particularly the mathematical tools for dealing with large populations and approximations, in solving physical problems. It can describe a wide variety of fields with an inherently stochastic nature. Its applications include many problems in the fields of physics, biology, chemistry, neurology, and even some social sciences, such as sociology. Its main purpose is to clarify the properties of matter in aggregate, in terms of physical laws governing atomic motion[1].

Statistical Physics deals with many particle systems. Systems are very many particles occur in: gas, liquid, solid and electromagnetic radiation (photons) Such a system is present on the system of physics, chemistry, biology. The study of many particles are used in virtually all areas of modern physics that saw the system from the standpoint of microscopic [2].

How different understanding of statistical physics with other subjects such as wave physics, thermodynamics and mechanics. In statistical physics, will depart from the abstract issue which is actually a mathematical study materials such permutations and combinations. Statistical physics can be regarded as a matter of mathematical statistics given the physical boundary conditions, so the problems of pure mathematics into having physical interpretation. Required abstraction high enough to understand these issues [3].

When dealing with the collection of gas particles, atomic or subatomic particles more, the use of statistics cannot be avoided. Therefore, the number of particles studied is very large, ie more than 10^{20} particles. Each particle has six variables to describe the complete state of motion, three spatial coordinates and the three components of momentum. Very unlikely to explain the dynamics of these particles one by one by the incredible amount of particles, despite using all the computers in the world today. The approach provided by statistical physics are seeing average properties of the particles without having to see the particles individually.

2.2 Media Web-Based Learning

As a rule, educational experiences that involve the learner physically and that give concrete examples are retained longer than abstract experiences such as listening to a lecture. Instructional media help add elements of reality – for instance, including pictures or highly involved computer simulations in a lecture. Kinds of media is internet website. The terminology, the website is a collection of pages of the site, which is summarized in a domain or subdomain, whose place is in the World Wide Web (WWW) on the Internet is a collection of web-documents that are scattered across multiple computer servers located around the world and connect into the network through a network called the Internet [4].

Almost 80% of internet service is the website. The main factor that makes the website is growing so fast is because of the spread of information through the website very quickly and cover a large area (worldwide), is not limited by distance and time, In addition, today again the trend of making a personal website or blog. Generally website has several functions, namely: communication function, the function of information, entertainment functions, and functions of the transaction (Asep Herman Suyanto, 2006: 5). Various functions held by the website leads development flexibility for various purposes, especially for improving the quality of learning. Web-based learning is a learning activity that utilizes media sites (websites) which can be accessed through the Internet. Web-based learning, also known as "web-based learning" is one of the implementation of electronic learning (e-learning). The advantages of web-based learning is independency (autonomy), accessibility and enrichment.

Independency (Independence) is the aspect of flexibility in the provision of time, place, teachers and teaching materials. This causes more centered to student learning (student-centered learning). Accessibility (accessibility) is a learning resources more accessible through distribution on the Internet with greater access than the distribution of learning resources in conventional learning and Enrichment (Enrichment) is a learning activity, presentation of course material and training materials as enrichment, allow the use of information technology devices such as video streaming, simulation and animation.

3. Materials and Methods

This research is a research development with 4-D models. Stage 4-D includes define, design, develop, and desiminate. Define phase is done by analyzing the course syllabus, analyze textbooks, reviewing literature media web-based learning, At the design stage, resulting model to be used as a web-based media. Develop phase consists develop a systematic framework for learning statistical physics that can be uploaded on the website. In Phase dessiminate, learning media of statistical physics that is ready for use and therefore need to be disseminated to immediately be used.

4. Results and Discussions

The results of this study are the availability of instructional media web-based statistical physics. Students designated or registered in this course can access the information and use it as a learning resource.

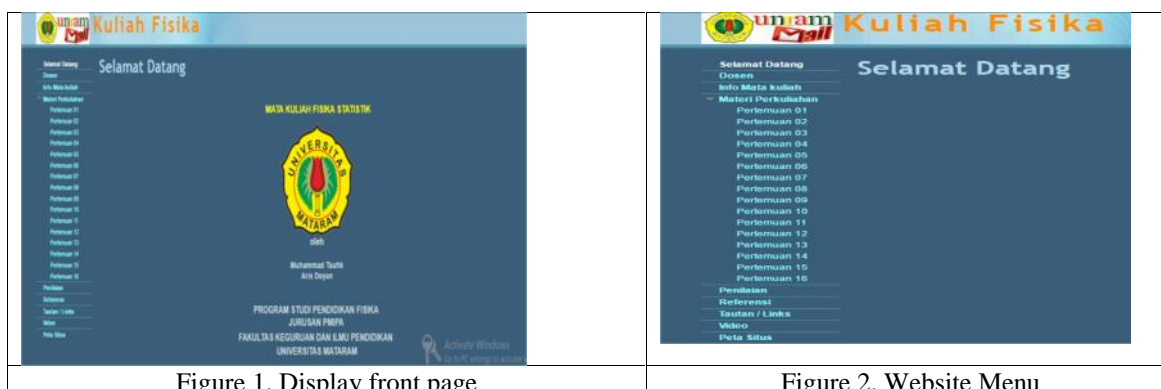

Figure 1. Display front page

Figure 2. Website Menu

In Figures 1 above is displayed the front page of the website or the welcome page lecture Statistical Physics. Then the page is also displayed in the form of a menu page or pages can be used as navigation browsing on the internet. These menus can be seen clearly in Figure 2. Menu prepared for learning purposes is a menu Welcome, lecturer, course info, Creative Class, Assessment, Resources, Links / Links, Video and Sitemaps. Explanation of each menu in outline, are presented in the following section navigation menu. The navigation menu on the website is the menu Welcome, lecturer, course info, Creative Class, Assessment, Resources, Links / Links, Video and Map Sites Menu lecture presentamaterials contain an outline of the lecture material, video from youtube, material and intact file that can be downloaded directly by students.

5. Conclusions

The web based media of statistical physics is available right now google site which is stored on google using mataram university mail, www.unram.ac.id and every students who has registered to the lectures can access that site.

References

- [1] https://en.wikipedia.org/wiki/Statistical_physics
- [2] Abdullah, Mikrajuddin, 2016, Fisika Statistik untuk Mahasiswa MIPA, <http://www.buku-e.lipi.go.id/utama.cgi?lihatarsip&mikr001&1363078185> diakses tanggal 10 Februari 2016
- [3] Hikam, AS, 2016, Fisika Statistik, <http://hikam.freevar.com/kuliah/fistat/> diakses tanggal 10 Februari 2016
- [4] MitraEdumedia Yogyakarta, 2010, Pembelajaran Berbasis Web, <http://mitraedumediayk.blogspot.co.id/p/pembelajaran-berbasis-web.html> diakses tanggal 10 Februari 2016

Potential for Mass Rearing of the Egg Parasitoids, *Ooencyrtus malayensis* and *Hadronotus leptocorisae* (Hymenoptera: Scelionidae) on *Nezara viridula* Eggs

Aisah Jamili^{1*}, Yen Kusnita¹

Faculty of Agriculture

¹University of Nahdlatul Wathan Mataram

*Email: qawlanhafidza@yahoo.co.id

Abstract

Ooencyrtus malayensis and *Hadronotus leptocorisae* are egg parasitoids, considered as ideal candidates for managing the *Leptocorisa acuta* through augmentative release. *Nezara viridula* eggs are extensively used for mass rearing. *O. malayensis* accepted eggs for parasitization, but not accepted for *H. leptocorisae*. This research of parasitization parasitoid were determined using mass *N. viridula* eggs. The eggs were exposed to female of 1-4 day old eggs parasitoid. Observation were conducted until 20 days. The study was conducted under laboratory condition with photoperiod of 12 hours light and 12 hours dark. The result percent parasitism *O. malayensis* and *H. leptocorisae* is different significantly ($P < 0,05$), *O. malayensis* parasitism was highest (70,00 % $\pm 14.47\%$), *H. leptocorisae* parasitism was (0 %) at 10 eggs/female parasitoid. The parasitism not significant when population different *O. malayensis* ($P > 0,05$). It is concluded that *N. viridula* parasitoid is suggested for mass rearing *O. malayensis*. Our objectives were to develop an efficient rearing technique for *L. acuta*, and to determine the basic bionomics and demographic parameter, necessary for future augmentative biological control programs.

Keywords: mass rearing, *Ooencyrtus malayensis*, *Hadronotus leptocorisae*

1. Introduction

Ooencyrtus malayensis and *Hadronotus leptocorisae* species are widely used egg parasitoids for biological control of insect pests *Leptocorisa acuta* through augmentation and release. In this process, a steady production or supply of the egg parasitoids. is essential to achieve successful control. Jamili and Haryanto (2012) found the *Ooencyrtus malayensis* and *Hadronotus* as parasitoid of *L. acuta*'s parasitized eggs in different location at Lombok. Our objectives were to develop an efficient rearing technique for *Leptocorisa acuta*, and to determine the basic bionomics and demographic parameter, necessary for future augmentative biological control programs.

2. Materials and Methods

This study was conducted during 2016 at the Department of Agrotechnology of Faculty of Agriculture, University of Nahdlatul Wathan Mataram.

2.1 Eggs parasitoid *Ooencyrtus malayensis* and *Hadronotus leptocorisae*

Ooencyrtus malayensis and *H. leptocorisae* parasitoid colony also are established by collecting the *L. acuta* egg parasitized from the same field of rice plant. Adult wasp which emerged from host eggs were maintained in glass tube at laboratory, and fed on 10% honey solution. Female wasp which had mated within 24 hours after emergence were used for

parasitization(1-4 day).

2.2. *Nezara viridula* Eggs

Nezara viridula were collected in soya bean plant field maintained without insecticides at Plasticcylinder 20x30 cm, under a 12L:12D photoperiod. The eggs of newly released by female *N. viridula* were put in a plastic cylinder (5x10 cm). Then attached on a thick paper (made of carton length 10 cm and weight 1 cm), each paper contain 10 egg items, then ready to parasited.

2.3. Host preference

Preference of *Ooencyrtus malayensis* and *Nezara viridula* parasitoid were determined using no choice test. *Nezara viridula* eggs were used as the proven alternate host for the rearing of *Ooencyrtus malayensis* and *Hadronotus leptocorisae*. Egg cards were prepared by using 10. The eggs were exposed to female of 1-4 day old eggs parasitoid. Egg cards in each batch were placed in 10 cm tall, 4.3 cm diameter glass vials separately. Diluted honey was supplied as food for the parasitoids. After 20 days, the egg cards were examined under a dissecting microscope (10 x 4, Olympus CX21) to determine the parasitization. The parasitized eggs could easily be detected as they turn black due to the developing immature stage of parasitoid inside the egg. The study was conducted under laboratory condition with photoperiod of 12 hours light and 12 hours dark. This experiment was replicated 7 time. Eggs parasitized were counted and percent parasitism was computed by dividing the number of parasitized egg by the total number of *N. viridula* eggs.

2.4. Effect of parasitoid densities on parasitism of *Ooencyrtus malayensis*

Fresh eggs of 1-4 day *Nezara viridula* 10 were glued on each card of the same size as mentioned above and kept in jars each with 7 replications. After sexing 1 female, 2 female and 1 pairs of *Ooencyrtus malayensis* were kept as mentioned above paragraph. After 24 h exposure *Ooencyrtus malayensis* were removed and after 20 days the data on percentage (%).

3. Results and Discussion

3.1. Potential use of *N. viridula* eggs for production of *O.malayensis* and *H. Leptocorisae*

Parasitoid *Ooencyrtus malayensis* accepted *N.viridula* eggs as a suitable host for parasitization. But not parasitoid *H. leptocorisae*. There were significant differences of acceptance between parasitoid (Figure. 1, *Kruskal wallis* $P < 0,05$). Mean of *O. malayensis* $70,00 \pm 14.47$ %, *H.leptocorisae* 0 %.

These results indicated that the *N. viridula* eggs could be mass rearing *Ooencyrtus malayensis*. Nothing of parasitized *H. leptocorisae* happened because the embryo *N. viridula* had developed into another stage and encapsulated. The aging, growth and development of host could influenced host immune system. This immune system would be threatening for parasitoid (Mattiacci & Dicke, 1995).

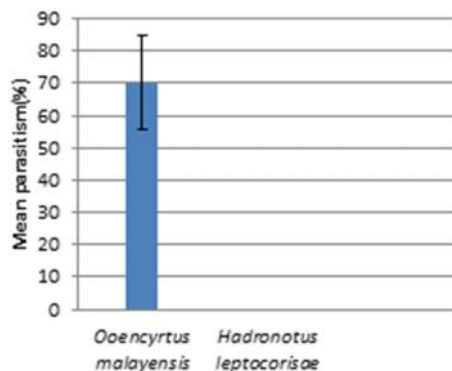

Figure 1. The Parasitism of *Ooencyrtus malayensis* and *Hadronotus Leptocorisae* on *Nezara viridula* eggs

3.2. Density of egg parasitoid *Ooencyrtus malayensis* from *Nezara viridula* eggs

The result percent parasitism *Ooencyrtus malayensis* did not different significantly among 1, 2 and 3 parasitoid densities (Figure 2 ; *One-way anova*, $F = 0.33$; $df = 2$; $P = 0,72$), *O. malayensis* parasitism was highest (85.00 ± 9.57) at 10 eggs/2 female parasitoid. while pairs (78.57 ± 9.86) and decreased of density one tail female (70.00 ± 14.47).

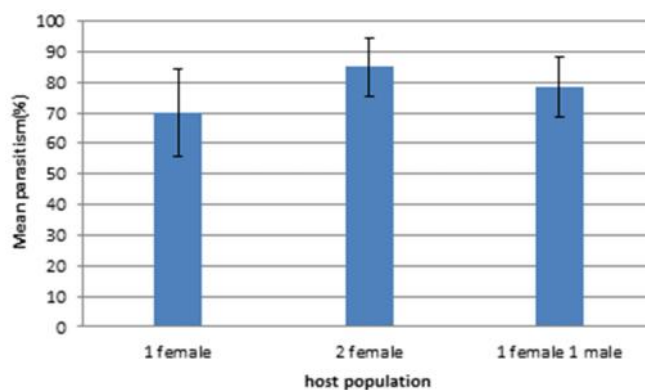

Figure 2. Parasitism of *Ooencyrtus malayensis* on *Nezara viridula* eggs of parasitoid density differently

The percentage of parasitized eggs was independent of parasitoid density at low densities of parasitoids and was inversely dependent at high densities. Khan et al. (2004) reported the highest parasitism (48.25%) at 20 eggs/single pair which is in agreement with our present study. Lu (1992) observed that increase in parasitoid density reduced the number of parasitized host eggs per female. Vorgas and Nishida (1982) observed that the parasitized species and the relative density of hosts affected the number of parasitized eggs.

4. Conclusions

Rearing *O.malayensis* using *N.viridula* eggs as alternate host is technically feasible. But not to *H. leptocorisae*. Potential for using *N.viridula* eggs for parasitization was evident. Percent parasitism *Ooencyrtus malayensis* did not different significantly among 1 female, 2 female and pairs(1 female and male) parasitoid densities.

Acknowledgement

Kemenristek Dikti is acknowledged for the financial assistance (Grant No.

008/SP2H/LT/DRPM/II/2016/ date 17 February 2016).

Referencesa

- [1] Jamili, A & Haryanto (2012). Potensi Parasitoid telur walang sangit pada Lokasi Pertanian Berbeda. Faperta Universitas Nahdlatul Wathan Mataram, Laporan Penelitian, 100 h
- [2] Mattiacci, L & Dicke, M. (1995). The Parasitoid *Cotesia Glomerata* (Hymenoptera: Braconidae) discriminates between first and fifth larval instars of its host *Pieris brassicae* on the basis of contact cues from grass, silk and herbivore-damaged leaf tissue. *Journal of Insect Behavior*, **8**(4), 485-497.
- [3] Khan MS, Farid A, Farmanullah K, et al. 2004. effect of host and parasitoid density on parasitism efficiency of *Trichogramma chilonis* (Ishii). *Asian Journal of Plant Sciences*, **3**(5): 647-650.
- [4] Lu QG. 1992. A laboratory study on the functional response of *Trichogramma* sp (Hymenoptera: Trichogrammatidae) in Kenya. *Chinese journal of Biological Control*, **8**(4): 151-154.
- [5] Vorgas RI, Nishida T. 1982. Parasitization by *Trichogramma chilonis ishii* (Hymenoptera: Trichogrammatidae) of corn earworm eggs on sweet corn in Hawaii. *Proceedings of the Hawaiian Entomological Society*, **24**:123-126

Factors Related to Stunting in Children Aged 24-59 Months in Narmada Public Health Care

Lina Nurbaiti¹, IDGN Agung², Umara Lani Anika¹, Arina Windri Rivarti¹, Dimas Pambudi Prakoso¹, Nabila Fawzia Putri¹, Nanda Retno Wardhani¹, Agus Gowinda Amijaya¹, Andri Irfan¹

¹Medical Faculty of Mataram University, West Nusa Tenggara, Indonesia,
²Narmada Public Health Care.

Abstract

The persistence cases of moderate and severe malnutrition in Narmada Public Health Care associated with the incidence of stunting. There were 36.43% children under-five who are stunted (short) and 14.12% severely stunted (very short) in the region of West Lombok. Stunting is a major nutritional problem in developing countries. Among 10 countries with the highest number of stunted children worldwide, six countries are in Asia, including Indonesia. Based on WHO data in 2012, stunting affected the growth of 162 million children under-five in the world. Stunting has long-term effects on individuals and society, such as cognitive deficits, poor physical development, decline in productivity, deterioration of health quality, and increase the risk of degenerative diseases. The objective of this study was to determine factors associated with stunting in children aged 24-59 months in Narmada Public Health Care. The study was a descriptive analytical cross-sectional approach. Rule of thumb method was used to determine samples. Samples in this study were 121 parents of children under-five. A questionnaire, FFQ and 2x24 hours food recall was used to collect the data. Statistical analysis used chi square method and logistic regression method. Results showed that 40% toddlers in the work area of Narmada PHC were stunted and 20% were severely stunted. Multivariate analysis showed that only energy intake ($p = 0,000$) that had a significant association with the incidence of stunting in children under five. The p -value of the test Homser and Lameshow is 0,600 and AUC values is 72.2%. Narmada as a part of West Nusa Tenggara had a serious nutritional problem (stunting) according to WHO classification 2005. Energy intake was found as the most influential factor on the incidence of stunting in children under-five.

Keywords: *Children Under-Five, Toddlers, Stunting, Narmada Public Health Centre, Energy Intake*

1. Introduction

Stunting is a reduced growth rate case in human development based on age, at the point of >2 of standard deviations ($<-2SD$) of the WHO child growth standards¹ nutrition status table. Africa (40%) and Asia (36%) have the world's highest number of stunting cases. Among 10 countries with the highest number of stunted children worldwide, six countries are in Asia that is Bangladesh, China, India, Indonesia, Pakistan, dan The Philippines².

Stunting prevalence in Indonesia in 2013 was 37.2%. This number increased compared to 2010 (35.6%) and 2007 (36.8). Within the 37.2% of stunting prevalence, 18.0% was severely stunted and 19.2% was stunted. The stunting prevalence increased from 18.0% in 2007 to 19.2% in 2013.³ According to Basic Health Research (RISKESDAS) in 2010, the prevalence of children of 24 – 35 months of age was higher with value of 41.4% followed respectively with 36 – 37 months of age (38%) and above 48 months of age (30.9%).⁴

Cases of moderate and severe malnutrition in Narmada Community Health Centre

were associated with incidence of stunting. The number of under-five children who gained weight (N/D) in Narmada Community Health Centre catchment area in May 2015 was 51.1%. This showed that the indicator target N/D determined by Health Office has not been achieved yet in which its target is 80%.⁵

Stunting has long-term effects on individuals and society, such as cognitive deficits, poor physical development, decline in productivity, deterioration of health quality, increase in the risk of degenerative diseases, and may inflict decline in Intelligence Quotient (IQ) of children, and disorders of psychomotor development and neurosensory integration.⁶⁻⁹

Previous study showed that nutritional problem factors in Community Health Centre catchment area were macro and micro energy intake, infectious diseases, parents' knowledge and family economic status.¹⁰ Another study found that there was a significant correlation between incidence of stunting and under-five children ungain weight in Community Health Centre catchment area, West Lombok District.⁵

Therefore, the researcher intended to do a further study by analyzing stunting risk factors in order to find a proper program recommendation to overcome nutritional problem in Narmada Community Health Centre catchment area.

2. Materials and Methods

The study used descriptive analytical cross-sectional approach, and was conducted in Narmada Community Health Centre catchment area to 24 – 59-month old under-five children. This study was conducted since the beginning of June until the end of June 2016.

The samples of this study were 24 – 59-month old under-five children in Narmada Community Health Centre catchment area. The samples were determined by using quota-sampling method. Rule of thumb method was used to determine the number of samples and added with correction factor of 10% resulting 121 samples.

Independent variables in this study were energy intake, protein intake, infectious diseases status, exclusive breastfeeding, immunization status, age of under-five children, gender of under-five children, birth weight of under-five children, parents education, parents occupation, and family economic status. Dependent variable in this study was stunted under-five children.

The descriptive analysis aimed at noticing the distribution of variable frequency which were energy intake, protein intake, infectious diseases status, exclusive breastfeeding, immunization status, age of under-five children, gender of under-five children, birth weight of under-five children, parents education, parents occupation, family economic status, and incidence of stunting. The bivariate analysis aimed at recognizing the correlation between variables. Multivariate analysis recognized the correlation value between dependent variable towards incidence of stunting on 24 – 59-month old under-five children in Narmada Community Health Centre catchment area. The analysis used logistic regression test.

The data then would be analyzed by using *software SPSS 16*. The food intake data would be analyzed by using *Software Nutrisurvey 2007*.

3. Results and Discussion

There were 121 of 24 – 59-month old under-five children in Narmada Community Health Centre catchment area that met the inclusion criteria to be the subject of the study, one child under-five was dropped out due to incompleteness of data. The characteristics of the subject of the study were energy intake, protein intake, infectious diseases status, exclusive breastfeeding, immunization status, age of under-five children, gender of under-five children, birth weight of under-five children, parents education, parents occupation, family economic status, and incidence of stunting.

The result showed that 40% of the children under-five in Narmada Community Health Centre catchment area were categorized as stunted, 20% as severely stunted, and 40% as normal nutrition status. This result was in accordance with the previous study in which the stunting percentage was of 43.2% with 56.8% for normal nutrition status on under-five children in Narmada Community Health Centre catchment area. WHO classifies an area into high prevalence when it has stunting percentage of 40%. Based on the data, it could be concluded that West Nusa Tenggara, in general, and Narmada as the part of West Nusa Tenggara are still in high prevalence category based on WHO 2015 classification.¹¹

Bivariate and multivariate analyses were implemented to find odd ratio value and determine which of the factors as the stunting risk factor. Based on the bivariate analysis, the significant factor associated to incidence of stunting in Narmada Community Health Centre catchment area was total energy intake with value of $p=0,000$ ($p<0,05$). Other factors did not have significant correlation to incidence of stunting in Narmada Community Health Centre catchment area ($p>0,05$).

Variables that would be tested using multivariate analysis had been selected by using bivariate analysis to find out the correlation between dependent and independent variables. The chosen variables were variables having values of $p<0,25$ on bivariate analysis. The chosen variables were dependent variables that were energy intake ($p=0,000$) and birth weight (0,152).

Table 1 Logistic Regression Test Result with Stunting Dependent Variable

	Var.	Coefficient	<i>p</i>	OR (IK95%)
Step 1	Energy Intake	1.895	0.000	6.655(2.908- 15.230)
	Birth Weight	1.251	0.283	3.495(0.355- 34.354)
Step 2	Energy Intake	1.920	0.000	6.818(2.992- 15.536)

Based on the multivariate analysis result, energy intake was the most significant factor. A deficient energy intake was 6 times riskier to worsen stunting condition on under-five children.

Test result of *Hosmer and Lemeshow* of $\text{sig.}>0,05$ ($p=0,600$) means that the model was sufficiently appropriate to explain the data in this study. The AUC value of 72,2% showed that the calculation system had average prediction capacity.

Energy intake was one of variables in this study to rate the under-five children food consumption. In this study, the energy intake was divided into two which were deficient energy intake ($< 100\%$ AKG) and adequate energy intake ($\geq 100\%$ AKG). The result showed that the percentage of under-five children having adequate energy intake was 48.3%, meanwhile the rest, 51.7%, was having deficient energy intake ($< 100\%$ AKG).¹⁰

The low rate of energy intake on stunting children group might be caused by some factors; among such were frequency and quantity of food consumption, low energy density, decrease in appetite, and infectious diseases.¹³ This study was in line with other studies stating that there was a significant correlation between energy consumption and incidence of stunting.^{14,15,16} It was caused by inadequate nutrition intake, mainly from total energy, relating to physical growth deficit on pre-school children.¹⁷ Inadequate number and nutrition of food intake was the direct cause of nutritional problem.¹⁸

4. Conclusion

Based on the study result, it can be concluded that most of the 24 – 59-month old under-five children in Narmada Community Health Centre catchment area were categorized as stunted (60%). Most of the 24 – 59-month old under-five children in Narmada Community Health Centre catchment area had deficient energy intake, normal birth weight, female, 24 - 35-month old; got exclusive breastfeeding, and suffered from infectional diseases for the last one month. All children under five received basic immunization. Most of the under-five children parents had low education, low economic status, non-working mother, and father working as a labor.

The most significant factor towards incidence of stunting on the 24 – 59-month old under-five children in Narmada Community Health Centre catchment area was energy intake. Energy intake had 6 times greater effects toward incidence of stunting.

Suggestions

The program of ASHAR (The First Thousand days of Life Action) shall be optimized, mainly in increasing the total energy intake to under-five children through Initiation of Early Breastfeeding, exclusive breastfeeding, complementary feeding started from 6-month old, breastfeeding until the child reach 2 years of age, observation of under-five children growth, and pregnant and breastfeeding mother nutritional improvement. In addition, it is suggested to optimize a balance complementaty feeding for under-five children - mainly for those suffering from nutritional problems -; increase the cadre knowledge about incidence of stunting, and nutritional problems on pregnant women, breastfeeding mother and under-five children; and to involve religious and communitiy leaders in increasing community awareness in order to prevent early marriage.

References

- [1] World Health Organization.(2012). Landscape analysis on countries' readiness to accelerate action in nutrition.
- [2] Badham Dan Sweet. (2010). Stunting: An Overview.*Sight And Life Magazine*.Vol 3 Pp: 40-47. South Africa
- [3] Basic Health Research (Riskesdas). (2013). *Litbangkes*, Health Department of Indonesia.
- [4] Province Health Office of West Nusa Tenggara. (2014). West Nusa Tenggara Health Profile (2014). West Nusa Tenggara.
- [5] Nurbaiti, Patni., et al. (2015). The Correlation between Incidence of Stunting and Ungain Weight on 24 – 59-month old under-five children in Narmada Community Health Centre catchment area. West Lombok: Narmada Community Health
- [6] Dalimunthe Sm. (2013). An Overview of Incidence of Stunting Factors on 24 – 59-month old under-five children in West Nusa Tenggara Province 2010.
- [7] Kusuma K.(2013). Risk Factor of Incidence of Stunting on 2-3-year old children (A study in East Semarang Sub-district) Nutrition Science of Diponegoro Medical Faculty
- [8] Fitri K. (2012). Birth Weight as the dominant factor to incidence of stunting on under-five children (12-59-month old) in Sumatera. Thesis. Depok.
- [9] Stephenson, et al. (2010). Consumming cassava as a staple food places children 2-5 years at risk for inadequate protein intake, an observational study in kenya and nigeria. *Nutritional Journal*.
- [10] Nurbaiti, Hidayatullah, dkk. (2015). An overview of the cause of ungain weight on 24-59-month old under-five children in Narmada Community Health Centre catchment area. West Lombok. Narmada Community Health
- [11] WFP. (2010).Food Security and Vulnerability Atlas of Nusa Tenggara Barat. Accessed on 30 June 2016 on <https://www.wfp.org>
- [12] Astari, L. D., A. Nasoetion, dan C. M. Dwiriani. 2005. *The Correlation between Family Characteristics, Nurturing Pattern, and Incidence of Stunting on 6-12- month old children. Media of Nutrition and Family* 29(20): 40 – 46. Accessed on 20 June 2016 on www.repository.ipb.ac.id
- [13] Asrar, M., H. Hadi, & D. Boediman,. (2009). Nurturing Pattern, Eating Pattern, Nutrition Intake, and their correlation towards Under-five Children Nutrition Status of Nuaulu Tribe Community in Amahai Sub-District, Central Maluku District, Maluku Province. *Journal of Nutrition Clinic of Indonesia*. Accessed on 20 June 2016 on www.ijcn.or.id
- [14] Neldawati. (2000). The Correlation between Feeding Pattern to Children and Other Characteristics and Nutrition Status of 6-59-month old under-five children at Community Nutrition Laboratorium, Research and Development Centere (P3GM) (Analysis of Secondary Data Malnutrition Under-five Children 2005). Depok: Community Health Faculty of UI.
- [15] Roscha Dkk, (2012). A Determinant Analysis of *Stunting on 0-23-month old children in underprivileged area in Central Java and East Java. A Panel of Nutrition Food* 35 (1):34-41. Accessed on 1 July 2016 on www.ejournal.litbang.depkes.go.id
- [16] Hidayah, N. R. (2011). Factors associated with Incidence of Stunting on 24-59-month old Under-five Children in East Nusa Tenggara 2010 (Analysis of Basic Health Research Data 2010) (Thesis). Depok: Community Health Faculty of UI.
- [17] Maxwell, Stephanie. (2011). "Module 5: Cause of Malnutrition". Accessed on www.unscn.org
- [18] UNICEF, (1998). *The State of The World's Children*. Oxford: Oxford University Press.

The Effect Of Shape And Number Of The Tube Of A Flat Plate Solar With A Gravel Absorber On Heat Transfer Rate And Collector Efficiency

Made Wirawan^{1*}, Mirmanto¹

¹*Mechanical Engineering Department, University of Mataram, Jl. Majapahit no. 62, Mataram, NTB, Indonesia.
* Email: wwiralo@yahoo.co.id*

Abstract

Solar energy can be used for heating fluid like gas or liquid. The utilization solar energy can be done using a solar collector. The optimized absorption of the solar energy depends on the collector dimension and component, e.g. the dimension of collector body, the form and shape of the tube, cover, isolation system and absorber material. The current research uses a gravel absorber with a variation of the shape and the number of tube. The shapes of tube absorber are serpentine and parallel. The numbers of the tube are varying from 5, 7 and 9 tubes. The water flow rates were varied from 250, 300 and 350 cc/minute to investigate the maximum performance. The results show that the solar collector heat energy is influenced by the shape and the number of the tube, water flow rates and resident time. The maximum heat transferring to the water occurred at the peak of the solar intensity at around 12.00 to 13.00 P.M. The highest collector efficiency was attained using the 5 parallel tubes and at the flow rate of 350 cc/ minute.

Keywords: *Collector, gravel, heat, tube*

1. Introduction

Solar energy is a renewable energy that has a high potential to be managed and developed, Burhanudin [1]. Indonesia is an area that is on track to 110LS 60LU equator, so Indonesia has much solar energy. Also, in Indonesia the sun may shine all year round. Hence, the solar energy in Indonesia has huge potential to be tapped and converted into useful energy [1].

Solar collector is a device that can be used to improve the effectiveness of direct solar energy utilization. The function of the device is to collect and transfer solar energy to other forms of energy or a useful energy Duffie and Beckman [2], Stefanovic and Bojic [3]. Therefore, in Indonesia, it is important to develop technologies that have that function above. One type of solar collector that is very simple and easy to be made/constructed is flat plate collector.

Solar collectors that are used in general are constructed from metal plates as absorber to absorb the sun's heat [2]. Nevertheless, in this study, the absorber was made of sand and gravel. This absorber is expected to replace the use of a metal absorber and to enhance the heat transfer rate. Based on this expectation, the effect of using different absorbers in this study is to obtain the optimal absorber.

The descriptions contained in the background can be used to discuss the objective of this study. The objective of this study is to know the effect of different absorbers; Case A (gravel absorber with sizes of 4.75 to 6.3 mm), Case B (gravel absorber with sizes ranging from 9.5 - 12.5 mm). The previous study indicated that the best absorber was the Case B, Wirawan and Sutanto [4]. Therefore, in this study the Case B was used with variations of passages and the number of tubes. Due to the variations, this study shows the best tube passage and the number

of the tubes used.

2. Materials and Methods

The experiments were performed at 10:00 am to 17:00 pm. Four identical collectors, see figure 1, were tested. First collector is constructed from a serpentine tube, while the second, the third and the fourth collectors are constructed from parallel tubes of 5, 7 and 9 tubes. The flow rates examined were 250 cc / minute, 300 cc / minute and 350 cc / minute. All of the collectors were placed with an inclination angle of 15° measured from a horizontal plane. All Temperatures were measured using K type thermocouples calibrated against a mercury thermometer, while the volumetric rate was measured manually using a glass volume meter and a stopwatch. The data were collected/recorded every 15 minute.

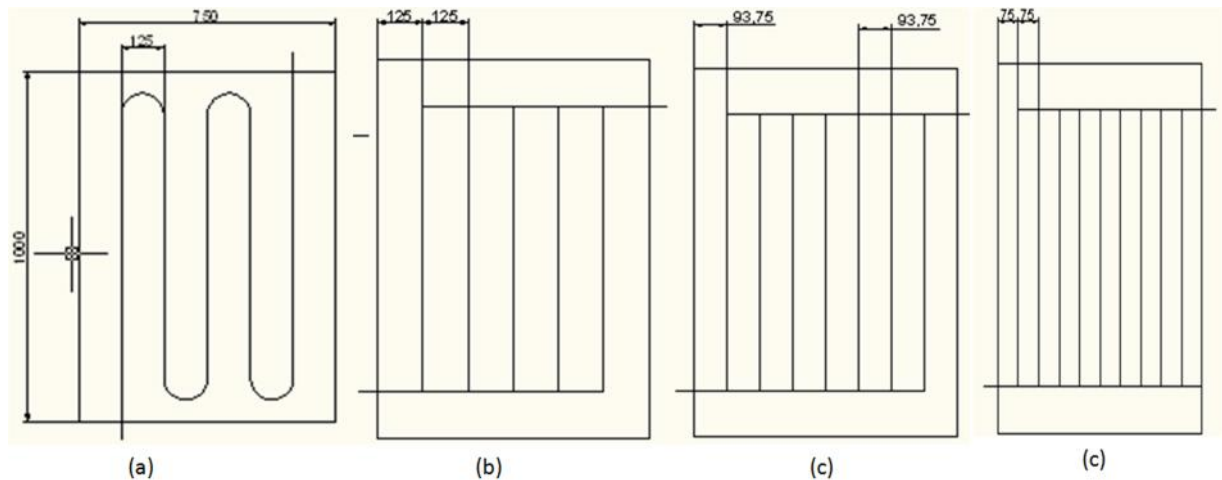

Figure 1 Absorber types; (a) serpentine, (b) parallel with 5 tubes, (c) parallel with 7 tubes, (d) parallel with 9 tubes

3. Results and Discussion

The rate of heat transfer from the collector to the water can be expressed by the amount of heat that can be utilized or used to heat water. In this study, the amount of heat absorbed by the water can be estimated by measuring the inlet and outlet temperatures. The amount of useful heat can be calculated using equation (1), Holman [5] and the results of the calculation are shown in figure 2.

$$q_{use} = \dot{m}c_p(T_o - T_i) \quad (1)$$

where q_{use} is the heat removed by the water, \dot{m} represents the mass flow rate, T_o is the temperature of water at the outlet and T_i is the inlet water temperature. It is very difficult to examine figure 2 because all lines are touching each other whether for the serpentine and parallel tubes.

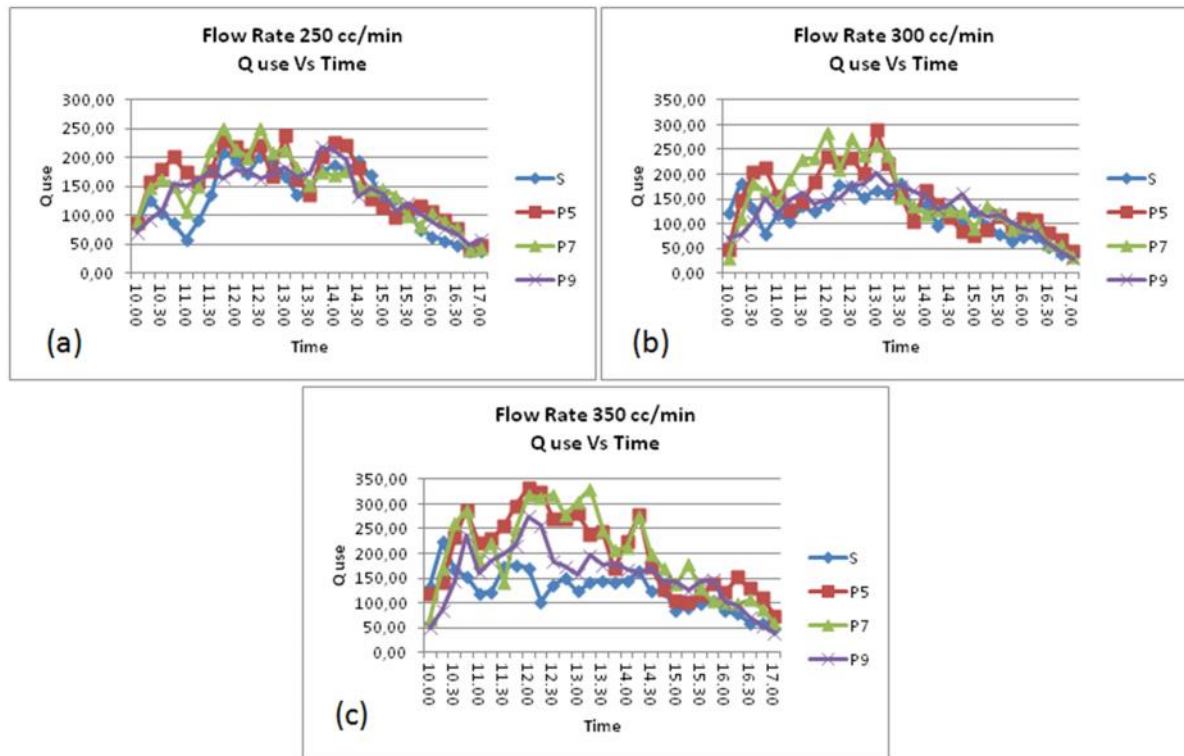

Figure 2. Heat removed by the water for volumetric rates of (a) 200 cc/minute, (b) 250 cc/minute and (c) 300 cc/minute.

Performance of the collector is determined by the amount of useful heat and heat input. One of performance indicators is an efficiency which can be expressed as [2]:

$$y = \frac{q_{use}}{q_{in}} \quad (2)$$

Efficiency represents how much a collector can convert the solar energy to be a useful energy or the useful energy divided by heat input [2]. The experimental maximum efficiency obtained is 43,44% at the mass flow rate of 250 cc / min, 48,07% for the parallel absorber with 7 tubes at a flow rate of 300 cc / min, and of 57,07% for the parallel absorber with 5 tubes at the mass flow rate of 350 cc / min.

4. Conclusion

Based on the research results and discussion, some conclusions can be drawn as follows:

1. The volumetric rate of the working fluid affects the amount of the heat removed by the working fluid (water).
2. The shape and number of tubes give small influences on the heat transfer rate and efficiency.

Acknowledgement

The authors would like to acknowledge the Indonesia Ministry Research, Technology, and Higher Education for the funding (Hibah Bersaing Grant 2016) and the Mataram

University for the facility.

References

- [1] Burhanudin, "Karakteristik Kolektor Surya Plat Datar Dengan Variasi Jarak Penutup Dan Sudut Kemiringan Kolektor", Skripsi, Universitas Negeri Solo, 2005.
- [2] J.A. Duffie and W.A. Beckman, "Solar Engineering Of Thermal Process", 2nd Edition, John Willey & Sons Inc., New York, 1980.
- [3] V.P. Stefonic and M.L. Bojic, "Development And Investigation Of Solar Collector For Conversion Of Solar Radiation Into Heat And / Or Electricity", Thermal Science 10, 2006, pp. 177-187.
- [4] M. Wirawan and R. Sutanto, "Analisa Laju Perpindahan Panas Pada Kolektor Surya Tipe Plat Datar Dengan Absorber Pasir", Jurnal Dinamika Teknik Mesin 1, 2011, pp. 65-72.
- [5] J.P. Holman, "Perpindahan Kalor", Penerbit Erlangga, Jakarta, 1988.

Waters Carrying Capacity for Developing Spiny Lobster Farming using Phosphorous Budget Approach in Ekas Bay, West Nusa Tenggara

Muhammad Junaidi

Study Program of Aquaculture, Mataram University

Email : junaidi_md@yahoo.co.id

Abstract

Phosphorous budget was applied to predict carrying capacity spiny lobster farming in floating net cages (FNC) at Ekas Bay, West Nusa Tenggara. Carrying capacity parameters were determined from physical properties such as total phosphorus content in a year, bay area, bay volume and water height and water flushing time. The calculation resulted in the value water carrying capacity for spiny lobster farming in FNC which is 512.40 tons/year which equals optimal production capacity or about 22,278 FNC units. These values can be used as a reference influencing local government policy for the development of spiny lobster farming at Ekas Bay.

Keywords : *carrying capacity, spiny lobster culture, budget phosphorus, Ekas Bay*

1. Introduction

Since 2000, lobster farming in floating net cages (FNC) has been developing at Ekas Bay, West Nusa Tenggara Province. At that time, there were so many spiny lobster seeds found attached on material such as buoy used to cultivate seaweed and grouper (Priyambodo and Sarifin, 2009). These seeds were taken and raised in FNC. This condition allows spiny lobster farming to sustain. Development of lobster farming at Ekas Bay shows that this activity has been a prime mover for coastal community's economy that has replaced fishing activity and finally reduces coral reef destruction. However, sustainability of this legitimacy is determined by environmental damage generated by spiny lobster farming. Some research has proven that grouper and lobster cultivations using FNC at Ekas Bay produce effluent that goes to water and affects water quality (Krisanti and Imran, 2006; Junaidi and Hamzah, 2014).

This water effluent consisting of food residue and fish feces in the long term will accumulate on water bottom (Rustadi, 2009). The water effluent, together with organic waste from land as a result of anthropogenic activities, will cause phytoplankton bloom or eutrophication that can lead to water pollution (Sachoemar, 2006). Therefore, in order for the farming to sustain, its development needs to be adapted to environmental (water) carrying capacity and water characters. According to that condition, there is a need of data and information used to determine environmental carrying capacity based on water characters at Ekas Bay.

2. Materials and Methods

Determination of water carrying capacity for the development of spiny lobster farming was done using an approach focusing on phosphorous budget (P). Main parameters used in the calculation were annual average of phosphorous total amount (TP, mg/L), bay area (A, m²), water volume at the bay (V, m³), average depth ($Z = V/A$, m) and flushing rate (, per year) calculated based on tidal exchange method (Barg, 1992). Following is the formula used

in the calculation, $(V_h - V_l) / (T \times V_h)$, where V_h = water volume at the bay during the highest tide (m^3), V_l = water volume at the bay during the lowest ebb (m^3), T = tidal period (day). Estimated value of annual total phosphorous applied in this study was based on the previous research (Junaidi et al., 2014) and phosphorous load as a result of spiny lobster farming and anthropogenic activities on the mainland.

According to the data elaborated above, it can be concluded that the determination of carrying capacity can be done using the following steps (Beveridge, 1987; Pulatsu, 2003) :

Step 1. Measuring steady state $[P]_i$ from total concentration of P determined based on annual average of total P concentration in water bodies. This was obtained from some representative samples.

Step 2. Determining $[P]$ maximum that can be accepted by water bodies $[P]_f$ as the result of spiny lobster farming in FNC.

Step 3. Determining water bodies carrying capacity for spiny lobster farming $\Delta[P]$ which is a difference between $[P]$ before the water bodies are used to farm the lobster $[P]_i$ and maximum phosphorous that can be accepted $[P]_f$ after the lobster farming exists. So, $\Delta[P] = [P]_f - [P]_i$

Therefore, $\Delta[P]$ is related to P load from FNC (L_{lobs}), the area of water bodies (A), flushing rate and the ability of water bodies to accept P load (ρ). Following is the formula generated:

$$\Delta[P] = L_{\text{lobs}} (1 - R_{\text{lobs}}) / Z\rho$$

$$L_{\text{lobs}} = \Delta[P] * Z * \rho / 1 - R_{\text{lobs}}$$

$$R_{\text{lobs}} = x + [(1 - x)R];$$

$$\text{In which, } R = 1 / (1 + \rho^{0.5})$$

in which, $\Delta[P] = P$ (g/m^3); L_{lobs} = total P ($g/m^2/year$); Z = average depth of water bodies (m); ρ = flushing rate (volume/year); R_{lobs} = total P soluble in the sediment); x = the total amount of P lost permanently into the sediment.

Step 4. If the area of water bodies (A), total P load that can be accepted (L_{lobs} , $g/year$) and total amount of P load lost into the environment throughout the farming activity (kg P/ton lobster) have been known, the amount of fish produced (ton/year) can be calculated using the following formula:

$$\text{Amount of fish produced} = L_{\text{lobs}} \times A / \text{total P}$$

3. Results and Discussion

Ekas Bay is located in southern part of Lombok Island, West Nusa Tenggara Province. Its position lies alongside north to south with geographical location between $8^{\circ}49'15'' - 8^{\circ}55'0''$ S and $116^{\circ}23'0'' - 116^{\circ}28'45''$ E. This Bay is on the opposite site of Indian Ocean and next to Alas Strait which connects water mass from Indian Ocean and Pacific Ocean. This has caused the bay to accept so much nutrient that it has a potential to be developed into a mariculture area (RDMF. 2004).

The result of RDMF observation (2004) shows that tidal range at Ekas Bay waters is about 2.6 m. According to tidal data collected, the area of Ekas Bay was 5,511.09 ha during the condition of Mean High Water Springs (MHWS), 3,821.56 ha during the condition of Mean Low Water Springs (MLWS) and 4,048.04 ha during the condition of Mean Sea Level (MSL).

Bay volume was calculated using Software Surfer 9.0 in the condition where in MHWS was $576,351,777 m^3$, MLWS was $534,113,527 m^3$ and MSL was $539,775,457 m^3$. According to the tidal data as well as volume and area of the bay, the flushing rate of Ekas Bay waters is $52.49 m^3/year$. Furthermore, the area of Ekas Bay which is appropriate for the development of

spiny lobster farming in FNC is 1,552.15 ha or 28.16% of the area in the condition of MHWS (Figure 1) (Junaidi et al., 2014).

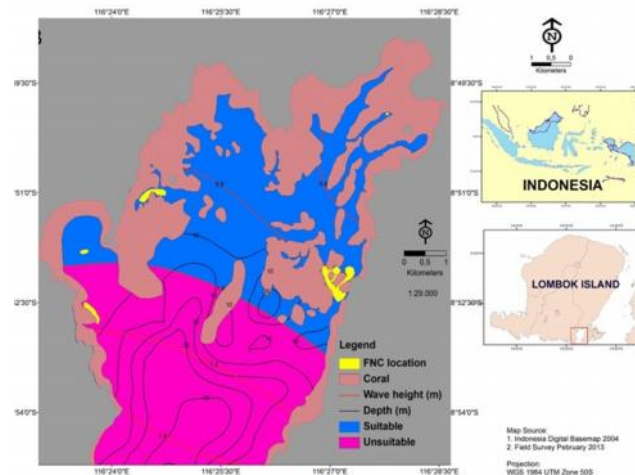

Figure 1. Map of Conformity of Spiny Lobster Farming Development at Ekas Bay
Source: Junaidi et al. (2014)

Parameters used as references in determining water carrying capacity consist of:

- Bay area appropriate for cultivation in FNC (A) = 15,521,500 m² (Junaidi et. al., 2014)
- Average depth (Z) = 8.5 m
- Bay volume (V) = 576,635,777m³
- Flushing time (ρ)=52.94 m³/year
- Shortly P (steady state) which is a result of measurement ([P]_i) = 2.2 mg/m³ (Junaidi and Hamzah, 2014)
- P maximum allowed ([P]_f) = 60 mg/m³ (Beveridge, 1996)
- P proportion lost permanently into the sediment (x) = 0.5 (Pulatsu, 2003)
- Total P load that goes into the environment =1,850.71 kg/ton of spiny lobster (Junaidi et. al., 2014)
- Spiny lobster productivity = 23 kg/FNC (Junaidi and Hamzah, 2014).

Referring to those parameters, carrying capacity calculation based on P waste load could be formulated as below:

$$\begin{aligned} \Delta P &= P_f - P_i = 60 - 2.2 = 57.8 \text{ mg/m}^3 \\ L_{\text{lobst}} &= \Delta[P] * Z * \rho / 1 - R_{\text{lobst}} \\ &= 57.8 * 8.5 * 52.94 / (1 - 0.578) \\ &= 25,783.88 / 0.422 = 61,096.14 \text{ mg/m}^2/\text{year} = 61.10 \text{ g/m}^2/\text{year} \\ R_{\text{lobst}} &= x + (1 - x) * R \\ &= 0.5 + (1 - 0.5) * 0.156 = 0.578 \\ R &= 1 / (1 + 0.747 * \rho^{0.507}) = 1 / (1 + 0.747 * 52.94^{0.507}) = 0.156 \end{aligned}$$

$$\begin{aligned} \text{Total Acceptable Loading (TAL)} &= L_{\text{lobst}} * A \\ &= 61.10 \text{ g/m}^2 * 15,521,500 \text{ m}^2 \\ &= 948,303,671 \text{ g or } 948,304 \text{ kg} \end{aligned}$$

Waste load from spiny lobster farming activities is 259.26 kg P/ton, whereas that of from non-farming activities is 1,591.45 kg P. According to these numbers, Total Acceptable Production can be calculated using following formula:

$$\begin{aligned} \text{Total Acceptable Production} &= \text{TAL} / \text{total P} \\ &= 948,304 \text{ kg} / 1,850.71 \text{ kg/ton} = 512.40 \text{ tons} \end{aligned}$$

If the productivity of FNC (3x3x3) m³ = 0.0023 tons/FNC, the total number of FNC allowed

to operate = $512.40 / 0.023 = 22,278$ FNCs. If a unit of raft has 9 FNC, the maximal number of raft allowed to operate = $22,278 / 9 = 2,475$ rafts.

4. Conclusion

The calculation resulted in the value water carrying capacity for spiny lobster farming in FNC which is 512.40 tons/year which equals optimal production capacity or about 22,278 FNC units. These values can be used as a reference influencing local government policy for the development of spiny lobster farming at Ekas Bay.

References

- [1] Barg, U.C. 1992. Guidelines for the promotion of environmental management of coastal aquaculture development. FAO Fisheries Technical Paper 328. FAO. Rome. 122
- [2] Beveridge, M.C.M. 1987. Cage and pen farming: carrying capacity models and environmental impact. FAO Fish. Tech.Pap.255. FIRI/T255,. Experiment Station, Auburn University, Alabama. 131 p.
- [3] Choi, K.D. 2002. Environmental management of marineculture in Hong Kong. The University of Hong Kong. hub.hku.hk/bitstream/10722/31198/15/FullText.pdf. Diakses Pebruari 2014.
- [4] Junaidi, M and M.S. Hamzah. 2014. Water quality and its effect on growth and survival rate of lobster reared in floating net cage in ekas bay, west nusa tenggara province. *Jurnal ITKT*, 6 (2) : 345-354
- [5] Junaidi, M., S. Andayani, M. Mahmudi and A. Sartimbul. 2014. Organic matter degradation in Lobster culture system and their effect on waters quality in Ekas Bay, Indonesia. Organic matter degradation in Lobster Culture System and their effect on waters quality in Ekas Bay, Indonesia. *Journal of Applied Biotechnology*, 2 (1) : 10-23.
- [6] Junaidi, M., S. Andayani, M. Mahmudi dan A. Sartimbul. 2014. Site Suitability for Lobster Culture Using Multi-Criteria and GIS Analyses in Ekas Bay, West Nusa Tenggara Province, Indonesia. *J. Coastal Conservation*, 18 (4)
- [7] Krisanti, M. and Z. Imran. 2006. Environmental carrying capacity of Ekas Bay for development grouper culture in floating net cages. *J.II.Perta.Ind*, 11(2): 15-20
- [8] Priyambodo, B. and Sarifin. 2009. Lobster aquaculture industry in eastern Indonesia: present status and prospects. In: K. C. Williams (Ed.), *Proceedings of an International Symposium on Spiny Lobster Aquaculture in the Asia-Pacific Region*, Australian Centre for International Agricultural Research, Canberra, p. 36-45.
- [9] Pulatsu, S. 2003. The application of a phosphorus budget model estimating the carrying capacity of Kesikkopru Dam Lake. *Turk J Vet Anim. Sci*, 27 : 1127-1130.
- [10] RDMF. 2004. The carrying capacity of fisheries and marine. Research and Development of Marine and Fisheries Ministry of Maritime Affairs and Fisheries. Jakarta 122 p
- [11] Rustadi. 2009. Control of eutrophication in reservoir using fisheries: case study in Sermo reservoir. *Aquacultura Indonesiana*, 10 (3): 199-208
- [12] Sachomar, S.I. 2006. Analysis of carrying capacity mariculture in Batam estate (BME) Batam. *J.Hidrosfir*, 1 (2) : 52-60

Immobilization of TiO₂ on Coal Bottom Ash and Its Activity Test as A Photocatalyst in Degradation of Methylene Blue Dye

Tuty Alawiyah^{1,*}, Nurul Hidayat², Endang Tri Wahyuni²

¹*Aquaculture Study Program, Mataram University, Nusa Tenggara Barat 55584, Indonesia*

²*Chemistry Department, Gadjah Mada University, Yogyakarta 55281, Indonesia*

Email : tuty_bae@yahoo.com

Abstract

Preparation and characterization of TiO₂ immobilization on bottom ash (TiO₂-bottom ash), and its activity test as a photocatalyst in degradation of methylene blue dyes have been conducted. The preparation was performed by adsorption using titanium (IV) isopropoxide as a source of Ti on bottom ash as a matrix, which followed by thermal treatment at 500 °C for 5 hours. The characterizations were performed using XRD and FTIR methods to determine the effect impregnated of TiO₂. The activity TiO₂-bottom ash photocatalyst on photodegradation of methylene blue dyes was carried out by batch method in a closed reactor with UV lamp and stirring system. Th degradation result of methylene blue was measured using UV-Vis spectrophotometer at 650 nm. The influences of the Ti concentration immobilization on bottom ash and applied TiO₂-bottom ash as photocatalyst have also been studied.

The result of the research show that the increase of Ti concentrations, can the increase of TiO₂ content in TiO₂-bottom ash with the same crystallinity. TiO₂-bottom ash shows higher activity in the process of photodegradation than the pure TiO₂, and bottom ash do. The longer irradiation time can increase the effectiveness of the photodegradation of methylene blue dye by TiO₂-bottom ash photocatalyst up to 300 minutes with the degradation result of 88.25%,

Keyword : *Photocatalyst, TiO₂-bottom ash, photodegradation, methylene blue*

1. Introduction

One source of environmental pollution is industrial waste which uses dye. The use of dyes is the most that the textile industry, such as methylene blue. In the textile industry dye staining residual waste as waste with a relatively large concentration of 20-200 mg/L (Pandey et al,2007).

According to environment minister's decision is Kep-51/MENLH/10/1995 on effluent quality standards, the maximum concentration of methylene blue allowed the 5-10 mg/L. One alternative that is currently evolving to address these problems by using semiconductor photocatalysts through photodegradation reactions. Wastewater treatment system using photocatalyst capable of degrading organic dyes or pollutants into components so that a simpler and safer for the environment, such as H₂O and CO₂. Besides photodegradation method is cheaper, more efficient in the use of chemicals, the process is faster, non-toxic and has the ability to use long-term (Bayati, 2010). In the method for removal catalyzed photodegradation of dyes or other organic compounds commonly used photocatalyst TiO₂ in powder form.

The use of TiO₂ in powder form for waste treatment in general is quite practical, but this powder will spread rapidly to a solution that can reduce its effectiveness. In order to increase the effectiveness of powder needed in large numbers. The use of TiO₂ powder in an amount too much can cause the solution became turbid and easily form a suspension so that the absorption of light by the substrate becomes less perfect, and will have difficulty in separating the solid photocatalyst. One effort to overcome these problems is with the material elicits the support or on a matrix material.

Bottom ash has not been reported as a carrier of the matrix material. With reference to the matter, in this study will be conducted testing the terembankan TiO₂ on the basis of coal ash (bottom ash) as a photocatalyst referred to as TiO₂-bottom ash. Of this research is expected, coal bottom ash which is a solid waste that can pollute the environment can be harnessed into useful materials.

2. Materials and Methods

The tools used in this study is reactor equipped with a set of magnetic stirrer, UV Lamp Black Light Blue (BLB) 40 watt 220 volt with a wavelength of 300-390. Laboratory glassware, IEC Centrifuge (International Equipment Company) AGIMATIC-N, X-ray Diffractometer type 6000X Shimadzu XRD, Infrared Spectrophotometer type Thermo Nicolet Avatar 360, and UV-Vis spectrophotometer 722.

The materials used in the study are Titanium (IV) Isopropoksida (TTIP) 97% (Merck), Abu basis of coal, ethanol 99.99% pa, Whatman 42 paper, Methylene Blue and distilled water. Preparation of TiO₂-bottom ash Photocatalyst is made by reacting as much as 2 grams of bottom ash with 100 mL of Ti (IV) in a variety of concentrations (0.1, 0.25, 0.5 and 1 M). The process was carried out with stirring for 24 hours with a magnetic stirrer. Further separation of solids and the filtrate using Whatman filter paper 42. The solid was then dried and calcined at a temperature of 500 ° C for 5 hours. The resulting photocatalysts were characterized using XRD and IR.

Photocatalytic test performed in a batch reactor system equipped with 40 Watt UV lamps and magnetic plate stirrer. For the solution of methylene blue and TiO₂ powder in erlenmeyer into the reactor and exposed to UV light while stirring with a magnetic stirrer for a certain time. Subsequently the suspension was centrifuged to separate the filtrate from the sediment with a speed of 3500 rpm for 10 minutes. The filtrate obtained was analyzed by using UV-Vis spectrophotometer at a wavelength of 650 nm to determine the

concentration of methylene blue degraded.

3. Results and Discussion

TiO₂-bottom ash preparation results further characterized by using XRD method to determine changes that occur after the immobilization of TiO₂ into the bottom ash. The results of characterization by XRD method is presented in Figure 1.

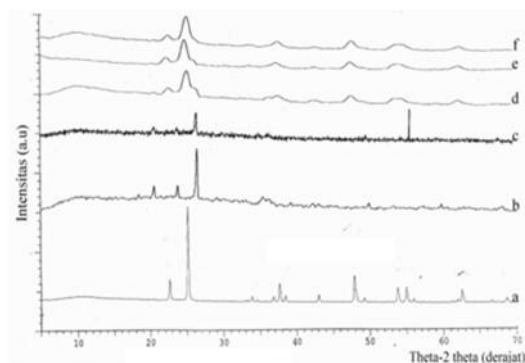

Figure 1. Difraktogram Sinar-X (a) TiO₂ Murni; (b) Abu dasar; (c) TiO₂-AD 0,1 M; (d) TiO₂-AD 0,25 M; (e) TiO₂-AD 0,5 M; (f) TiO₂-AD 1 M

Figure 1 above shows that the difraktogram TiO₂-bottom ash with the lowest Ti concentration give peaks with the same difraktogram bottom ash and has not seen peaks of TiO₂. This indicates that the crystallinity and the amount of bottom ash is still dominant than TiO₂ formed. The increase in Ti concentration of 0.25 to 1.0 M give diffraction peaks similar to TiO₂ despite lower and wider than TiO₂. This indicates that the TiO₂ crystals have formed in the bottom ash with a lower crystallinity than the TiO₂ powder. This happens because the TiO₂ structure formed on the surface of SiO₂ and Al₂O₃ from the ashes of the base so that the crystal growth is not perfect. Besides the peaks of SiO₂ and Al₂O₃ in the bottom ash is not seen, which indicates that the SiO₂ and Al₂O₃ have been covered by TiO₂ crystals dispersed on the surface of the bottom ash. To strengthen the results of XRD characterization using the method in this study to identify the groups functions contained in the photocatalyst TiO₂-bottom ash and the possibility of developing of using an infrared spectrophotometer. The results of the infrared spectra presented in Figure 2.

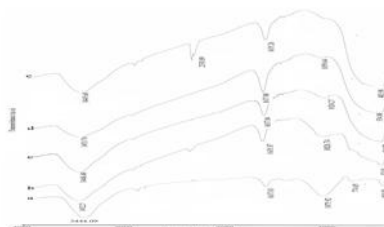

Figure 2. Spectrum of FT-IR a) Abu dasar; b) TiO₂-AD 0,1 M; c) TiO₂-AD 0,25 M; d) TiO₂-AD 0,5 M; e) TiO₂-AAD 1 M 0,25 M; d) TiO₂-AD 0,5 M

Figure 2 shows that the bottom ash gave absorption at wavenumber 1075.92 cm⁻¹ and 774.85 cm⁻¹ are characteristic for the group O-Si-O and Al-O or the Si-O that can be derived from the Al-OH and or the Si-OH and H₂O molecules. TiO₂ provide

successive absorptions at wave number 3441 cm^{-1} , 2337.2 cm^{-1} , 624.9 cm^{-1} which showed a TiOH, TiO₂, and the double layer of TiO. The results of infrared spectra for TiO₂-bottom ash with varying levels of uptake-uptake gave similar IR spectra of bottom ash and TiO₂. It is also seen that the absorption at wavenumber 469 cm^{-1} (Si-O/Al-O) in bottom ash has shifted to $470\text{-}540\text{ cm}^{-1}$. This indicates that the TO₄ (SiO₄ or the AlO₄) has interacted with the Ti-O in TO₂. Ti ion can be bound to the O atom and the other rich TiO₂ electrons so that can form a double layer on the surface of TiO₂ bottom ash.

To determine the effect of TiO₂ on the of bottom ash in this study has been carried out photodegradation of methylene blue by the addition of TiO₂- bottom ash photocatalysts are compared to the photodegradation with TiO₂ and addition of bottom ash. Conditions in the photodegradation process is the concentration of methylene blue dye 50 ppm, the mass of the photocatalyst 50 mg, and 300 minutes of contact time. The results are presented in figure 3.

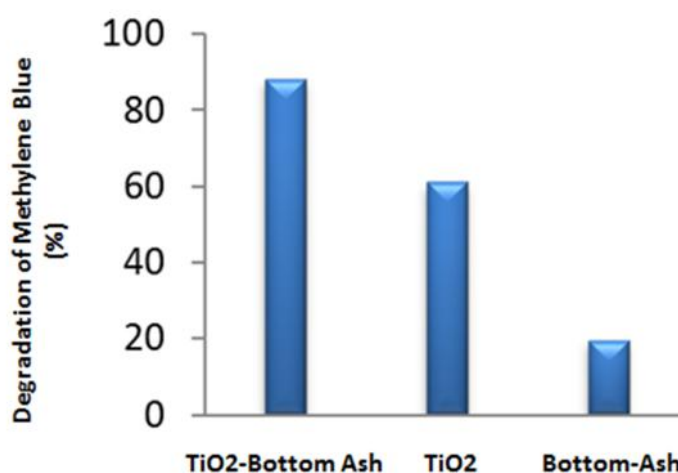

Figure 3. Fotodegradation of methylene blue dyes with using TiO₂-bottom ash, TiO₂, and Bottom ash

Figure 3 shows that the addition of TiO₂-bottom ash, TiO₂, and bottom ash can cause the removal of methylene blue from solution. By irradiating the loss of methylene blue from solution due to the photodegradation reaction by OH · radicals and or absorption on the surface of TiO₂-bottom ash, TiO₂, and bottom ash. In the process of irradiation, OH · radicals can be formed from the photolysis of water and TiO₂ photocatalysis.

The results showed that the effectiveness of TiO₂ photocatalysis-bottom ash is higher than the TiO₂ powder. This is because the particle size of TiO₂ after rest upon the bottom ash to be relatively small so that its surface area becomes larger. Photocatalyst surface area greater contact between the beam and result in a more effective photocatalyst so that the amount of OH · radicals are formed more and more, resulting in a higher effectiveness of photodegradation. particle size becomes smaller, so give fotoactivity higher than TiO₂.

The effectiveness of the process of photodegradation of methylene blue using TiO₂ photocatalyst powder, lower. This is because in addition to larger, TiO₂ is also easily spread so as to form a suspension. This leads to the formation of OH · radicals and the interaction between UV light contact with the methylene blue is reduced, so the photodegradation becomes less effective.

The addition of bottom ash on the photodegradation of methylene blue the lowest yield. Omission in this state due to photodegradation by OH· radicals that only comes from the photolysis of water.

4. Conclusion

Based on the results of research and discussion can be concluded as follows:

1. Immobilization of TiO₂ on bottom ash gave higher fotoaktivitas, both on the photodegradation and the adsorption of methylene blue than the pure TiO₂, and bottom ash with the results of effectiveness degradation is 88.25%, 61.23% and 19.57%.
2. The increase in the concentration of Ti (IV) which rest upon the bottom ash to increase levels of TiO₂ in the TiO₂-bottom ash with the same degree of crystallinity. And rising levels of TiO₂ which rest upon the bottom ash to increase the effectiveness of photodegradation of methylene blue dye.

References

- [1] Attia, J Abbas., 2007, Photocatalytic Degradation of Textile Dyeing Wastewater Using Titanium Dioxide and Zink Oxide, *E-Journal of Chemistr*, Vol.5, No.2, pp.219-223.
- [2] Bayati, Fard,G. Dan Moshfegh,, Photo-Degradation of Methylene Blue over V2O5-TiO2 Nano-Porous Layers Synthesized by Micro Arc Oxidation., *Catal Lett*, 134:162-168.
- [3] Burrows, H.D., Ernestova, L.S., Kemp, T. J., Skurlatov, Y. I., dan Purmal, A.P., dan Yermakov, A.N., 1998, Kinetics and Mechanism of Photodegradation of Chlorophenols, *Sci. Technol. Lett.*, 23, 145-207.
- [4] Ekimov, A.I., Effros, A.I.L. dan Anuchenko, A., 1985, Quantum Size Effect in Semiconductor Microcrystal; *Solid State Commun.*, 5611, 921-1524.
- [5] Fatimah.I, dan Wijaya.K., 2005, Sintesis TiO₂/Zeolit Sebagai Fotokatalis Pada Pengolahan Limbah Cair Industri Tapioka Secara Adsorpsi dan Fotodegradasi, *J Teknoin*, Vol 10 : 257-267.
- [6] Ghanizadeh, dan Asgari.G., Adsorption kinetics dan isotherm of methylene blue and its removal from aqueous solution using bone charcoal, *Reac Kinet Mech Cat*, 102:127-142
- [7] Gunlazuardi, J., 2001, Fotokatalisis pada permukaan TiO₂ : Aspek Fundamental dan Aplikasinya, *Prosiding Seminar Nasional Kimia Fisika II*, 1-5
- [8] Hamdaoui, dan Chiha., 2006, Removal of Methylene Blue from Aqueous Solutions by Wheat Bran, *J.Acta Chim*, 54, 407-418
- [9] Nyquist, R.A., 1997, *Infrared and Raman Spectral Atlas of Inorganic Compounds and Organic Salts*, vol 3, Academic Press, London
- [10] Pabon. E, Retuert, Jaime, Quijada, Raul, Zarate dan Antonio, 2003, TiO₂-SiO₂ Mixed Oxide Prepare by a Combined Sol-Gel and Polymer Inclusion Method, *Micropor. Mesopor. Mat.*, 67, 195-203
- [11] Pandey, A., Singh, P., Iyengar, L.Review Bacterial Decolorization and Degradation of Azo Dyes. *International Biodeteration & Biodegradation* 59 (2007) :73-84
- [12] Xu., Effect of Particle Size of TiO₂ on Photocatalytic Degradation of Methylene Blue in Aqueous Suspensions, *J.Ind. Eng.Chem, Res.*, 38(2) : 373-379
- [13] Visa. M., Adronic. L., Lucaci. D., dan Duta. A., 2010, Concurrent Dyes Adsorption and Photo-degrdation on Fly ash Based Substrates, *J.Adsorption* (2011) 17: 101-108

Design of Low Frequency Vibration Generator As Seismic Sensor Calibrator with Optocoupler Counter

Yulkifli¹, Rahadi Wirawan², Yoggy Refiyon³,

¹ Department of Physics, State University of Padang, Padang, Indonesia

² Department of Physics, University of Mataram, NTB, Indonesia

³ Department of Physics, State University of Padang, Padang, Indonesia

E-mail: yulkifliamir@yahoo.com, rwirawan@yahoo.co.id, refiyonyoggy@gmail.com

Abstract

A sensor is an important component in measuring and controlling system. Several sensors use the high technology to fabricate such as a vibration sensor. Consequently, its make a vibration sensor have a high price and rarely in the market. Therefore, many researchers develop it to get a sensor with good a characteristic and low price. In order to get a good characteristic of vibration sensor, we required the low frequency vibration generator as sensor calibrator. This paper presents the design of a low frequency vibration generator instrument as a seismic sensor calibrator using an optocoupler counter sensor. The vibration generators consist of a mechanical and an electronic system with separate in two different boxes. A direct measurement was conducted to measure the sensor output and the time to count the frequency. The accuracy and precision were determinate based on the indirect measurement (statistical and graphical analysis). Testing result of the instrument shows that the sensor accuracy is about 94.2% with average of correctness 0.955. Accuracy average of vibration generator is 0.98 and the precision is about 0.976.

Keywords : *vibration generator, low-frequency, seismic sensor, calibrator, optocoupler counter*

1. Introduction

Sensor is a primary electronic component that used in the measurement system or control system. A sensor can be applied to built a system that works automatically and able to analyze the phenomena that occur in the nature. Sensors are used to construct a type of measurement or control system according to the physical quantity that can be sensed by a sensor such as the detection of vibration. Wirawan et al. (2012) develop an instrument based on the ultrasonic sensor to measure the vibration frequency of the object [1].

Vibration detection is able to provide vibration parameters that detected by sensor. Through this information can provide an early warning to prevent fatal damage due to the effect of vibration. This detection system is required to detect vibration and engine work analysis, vibration power bridge analysis, building strength vibration analysis, and earthquake. Especially for the natural vibration like an earthquake, it's requiring vibration measurement in the low frequency. For the purposes of developing a vibration detector, there are many varieties of sensors and other devices that response a vibration such as geophone sensors, piezoelectric, accelerometer, and etc. Generally the sensor material is semiconductor, optic materials, or metal and its need high technology to build a sensor. In 2011, we develop the vibration sensor based on the fluxgate [2]. In order to test the reliability and the characteristic of a vibration sensor system, especially for the low frequency vibration, we required the vibration measuring instruments especially for test equipment, calibrator, and vibration generator.

The low-frequency vibration generator produces low-frequency mechanical vibration wherein one of these vibrations is an earthquake vibration with the dominant frequency range from 1 to 5 Hz. In this paper, we present the design of a low frequency vibration generator instrument as seismic sensor calibrator. We were using a DC motor as an actuator and optocoupler sensor as counter sensor. DC (direct current) motors converts direct current electrical energy into mechanical energy [3]. DC motors are used because of its speed can be varied so that it can be used to regulate the frequency. In addition, DC motors also have high torque, linear performance, and simpler control system [4].

2. Materials and Methods

There are two types of work conducted in this research i.e. hardware and software design.

2.1 Hardware design

The design of Low Frequency Vibration Generator as Seismic Sensor Calibrator with Optocoupler Count can be seen in Figure 5. The main component that used in this the design are DC motor, optocoupler sensors, liquid crystal display (LCD), ATmega 8535 microcontroller. In order to produce an accurate data, its must complete a certain specification that give a description of the research product. There are two types of specifications, design specifications (Figure 1) and performance specifications. A performance specification is to identify the functions each of the components form the system, while design specifications also called the functional specification.

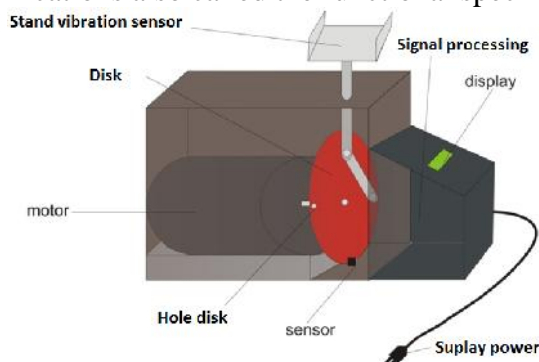

Figure 1 Design of low frequency vibration generator

The instrument has separate mechanical and electronic systems. Mechanical system and electronic system is connected by connecting cables. Both of these systems were deliberately separated so that the resulting vibration actuator does not interfere with the performance of the electronic components.

2.2. Software design

The controlling program that will be embedding to the microcontroller chip in order to control of the instrument work was written. The program was build using the CodeVision AVR program based on C programming language. Figure 2 shows the flowchart of the controlling program.

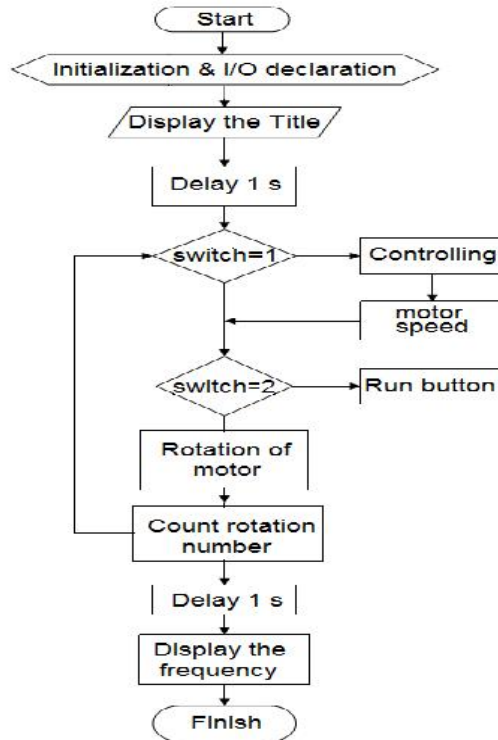

Figure 2 Flowchart of the controlling program

The measurement results can be expressed in a specified average value, standard deviation, and the relative and absolute error of measurement results. The accuracy and precision of the system was determined using the theory of errors. The percentage of error can be determined based on the equation:

$$\% \text{ Percent error} = \frac{Y_n - X_n}{Y_n} \times 100\% \quad (1)$$

where Y_n is an actually value and X_n is the value measurement.

For the relative accuracy (A) of a measurement system can be determined by the following equation [5].

$$A = 1 - \left| \frac{Y_n - X_n}{Y_n} \right| \quad (2)$$

and the precision of a measurement can be expressed in mathematical form as follows:

$$\text{Precision} = 1 - \left| \frac{X_n - \bar{X}_n}{\bar{X}_n} \right| \quad (3)$$

where X_n is the value of the n-th measurement and \bar{X}_n is the average of a set of n measurements.

3. Results and Discussion

The Figure 3 shows the low frequency vibration generator that has been made. The low-frequency vibration generating consists of two parts i.e. an electronic circuit system (Figure 3a) and a mechanical system (Figure 3b) that placed in two different boxes. The electronic circuit system of low-frequency vibration generator consists of a power supply circuit (1) as a current source, PWM (2) as a DC motor speed control, microcontroller minimum system (3) as the centre of controlling program of the systems, and optocoupler

sensor circuits (4).



Figure 3. Low-frequency vibration generators.

The mechanical system consists of several components i.e. a vibrating lever (1) that functions transform transformation circular motion into vertical motion, DC motor (2) function for the driving source (actuator), torque driver (3) serves to provide more big torque on vibrating sleeve, disc (5) and optocoupler sensor (4) for chopping round amount of low frequency vibration generator as shown in the inset of the Figure 3b. The number of vibration, time and the frequency will be displayed in the LCD module. In order to operate this generator, there is a button which serves to start the running system, to stop system and restore the original position readout. In addition to control the motor speed there is a rotary switch. When the DC motor rotates, it will rotate a disc and moving the arm to vibrate vertically.

Data analysis was performed on the low-frequency vibration generating system includes sensor characteristics, PWM output voltage relationship of the adjustments are, as well as the accuracy and precision of generating low-frequency vibration.

3.1. Accuracy and precision of optocoupler sensor

Optocoupler sensor emits infrared light from the transmitter to the receiver. When the transmitter and receiver blocked by obstacles, it will cause changes of the sensor output voltage. From the datasheet, the output voltage sensor is about 5 volts. The obtained measurement shows that the blocked voltage is 4.71 volts and the unblocked voltage is 0.0065 volts. According to this measurement result, the accuracy of the sensor is 94.2%. The discrepancy of the voltage due to the influence of the sensor cable is long enough so that the voltage drop occurs in the sensor. In addition, the repeated measurement of the sensor in case of blocked and unblocked was conducted to obtain the sensor precision. The unblocked optocoupler sensor precision is 0.999, whereas the blocked precision is 0.892.

3.2. Correlation between frequency and DC motor input voltage

The correlation between the input voltage DC motor with frequency is shown in Figure 4.

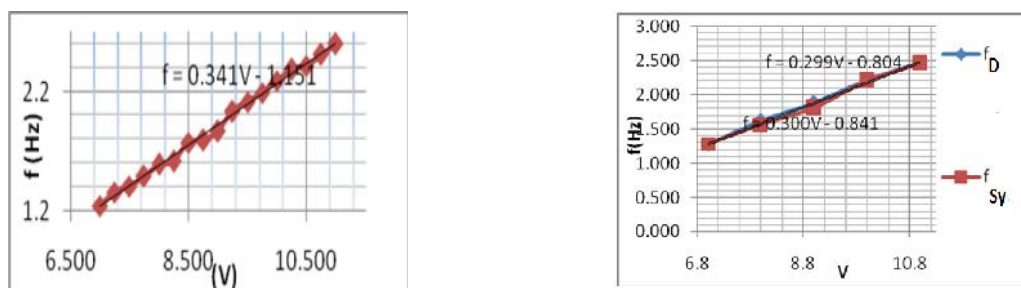

Figure 4 The correlation between the voltage and frequency.

From the graph it can be seen that increases of voltage make the frequency increase too. The correlation of frequency and the voltage can be depicted by the following regression line equation $f = 0.34V - 1.151$ where the coefficient 0.34 is the sensitivity to changes in voltage DC motor speed and the 1.151 constant is the initial frequency.

Figure 5 Graphic of the frequency accuracy (f_D vs f_{Sy}).

3.3. Low-frequency vibration generating accuracy

The accuracy of a low-frequency vibration generator is determined by comparing the measured data (f_D) to a standard measuring system (f_{Sy}). The precision of the low-frequency vibration generator can be seen in graphic of the Figure 5. The graphic shows the comparison between the measured frequency curves and the frequency count. Measurements and calculations results which represented by two line with the line equation $f = 0.299V - 0,804$ for a measurement and $f = 0.3V - 0,841$ for a calculation. The error percentage range is from 0% to 4.3289%. Meanwhile, the accuracy of the vibration generator systems ranged from 92% to 99%.

3.4. Absolute and relative error

For the 10 times of measurement, the average accuracy of low frequency vibration generating is 0.976, while the average error is 0.019. Absolute error of low frequency vibration generating system can be seen in Figure 6.

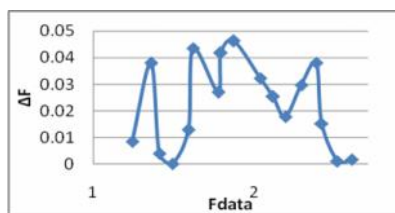

Figure 6. The graph of an absolute error

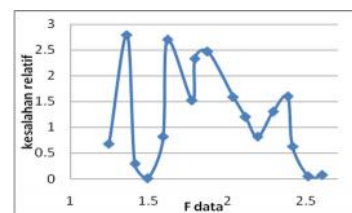

Figure 7. The graph of relative error

Based on sinusoidal shaped graph the Figure 6, the maximum of an absolute error values is 0.046. Meanwhile, the relative error of the system is ranged from 0% to 2.793% as shown in Figure 7.

4. Conclusion

Based on the analysis results of a Low Frequency Vibration Generator as Seismic Sensor Calibrator With Optocoupler Count that has been done, it can be drawn some conclusions that the accuracy of low frequency vibration is about 94.4%, the precision of the sensor is obstructed during 0.892 and 0.999 when there is unobstructed, with a relative error is 0.279. The generated voltage influences proportionally the vibration frequency. The average accuracy of the low-frequency vibration generator system is 0.98% with an average relative error 1.90%.

References

- [1] Wirawan R., Mitra Djamal, Ambran Hartono, Edi Sanjaya, Widyaningrum Indrasari, dan Ramli Aplikasi Sensor Ultrasonik Untuk Pengukuran Getaran Frekuensi Rendah, Prosiding Simposium Nasional Inovasi Pembelajaran dan Sains, Bandung, 37-41(2012).
- [2] Mitra Djamal, Yulkifli, Agung Setiadi, Rahmondia N. Setiadi. (2010). Development of a Low Cost Vibration Sensor Based on Fluxgate Element. Proceedings of the International Conference on Circuits, Systems, Signals. p. 248-251.
- [3] Zamroni, M. (2006). DC Motor Control For Mechanical Drive In Bracket Wall LCd Projector and Screen-

Based Microcontroller AT89S51. Diponegoro University, Semarang.

[4] Malvino, Albert Paul. (1999). Basic Principles of Electronics Volume I. New York: McGraw.

[5] Jones, L. D., Chin, A.F. (1995). Electronic Instruments and Measurement Second Edition. Prentice Hall-International, Inc.

Measuring and Mapping Carbon and Nitrogen in Indonesian Tropical Soil using Rapid Technique of Near Infrared Technology

B.H. Kusumo^{1,*}, Sukartono¹, Bustan¹, C.W.H. Anderson², C.B. Hedley³, M.J. Hedley²,
M. Camps Arbostain^{2,4}

^a Department of Soil Science, Faculty of Agriculture, The University of Mataram, JL. Majapahit No. 62 Mataram, Lombok, Indonesia.

^b Institute of Agriculture and Environment, College of Science, Massey University, Private Bag 11-222, Palmerston North, New Zealand.

^c Landcare Research, Private Bag 11-052, Palmerston North, New Zealand.

^d New Zealand Biochar Research Centre, Massey University, Private Bag 11222, Palmerston North 4442, New Zealand.

*Corresponding author: B.H. Kusumo (bambanghk@gmail.com; bambanghk@unram.ac.id)

Abstract

Measuring and mapping soil carbon (C) and nitrogen (N) using conventional laboratory analysis (e.g. Walkley&Black and Kjeldahl method, respectively) is high cost and time consuming. The cost can be more expensive for producing spatial and temporal mapping of soil C and N, due to more samples needed. Near Infrared Spectroscopy (NIRS), which is known as a rapid and inexpensive technique with no chemical needed, has been successfully able to rapidly measure soil C and N in laboratory and in the field. The aim of this research is to develop rapid and cheap technique from soil reflectance in measuring and mapping soil C and N which in turn can be used as a basis of site specific fertilizer recommendation. Soil samples were collected from tropical soil of Kayangan Area of North Lombok Indonesia which were then analysed using conventional analysis and scanned by NIRS. Partial Least Square Regression (PLSR) models were built from reference data (conventional analysis) and spectral data (NIRS). The models were moderately successful to measure soil C and N from spectral reflectance, both using cross-validation test and using separate validation sample set. This indicates that soil C and N from Indonesian tropical soils of North Lombok can be rapidly measured and mapped using Near Infrared Technology.

Keywords: *Soil, carbon, nitrogen, rapid measurement, mapping, near infrared*

1. Introduction

Measuring soil carbon (C) and nitrogen (N) using conventional methods (e.g. Walkley & Black and Kjeldahl method, respectively) is high cost and time consuming. Soil samples have to be collected, dried, ground, sieved and analyzed in laboratory (Minasny *et al*, 2013). The cost could be much higher for mapping soil C and N status in more detail scale, due to more samples needed. So, it is usually coarse scale map (e.g. 1:500,000 or coarser) is affordable if we only rely on the conventional methods. Hence, detail scale of soil nutrient map is extremely needed for site specific fertilizer application in order to put fertilizer with the right amount and at the right place.

Ideally, prior to fertilizer application, it should be available a detail scale of soil nutrient map which can be used to guide the farmer to apply the right kind and amount of fertilizer (Kodaira and Shibusawa, 2013). Higher amount of fertilizer should be applied at the area with lower content of soil nutrient, and vice versa. At the current situation, however, fertilizer (organic and inorganic)

recommendation is commonly based on regional recommendation, which may cause inefficient use of fertilizer which can be below or above ideal recommendation rate (*personal communication*). In fact in the field, soil nutrient status can be very different from one place to the other places, which need different amount of fertilizer. Thus rapid and inexpensive technique is needed to measure and map soil C and N for site specific fertilization (site specific management).

Near infrared spectroscopy (NIRS), which is rapid and inexpensive technique and no chemical needed, has become an extremely important analytical technique in recent years (Stenberg et al, 2010). It is used to analyze a wide range of samples from gas, liquid, to solid (Stuart 2004). It is used to measure organic composition and functional properties in e.g. crops, food, animal feed, pharmaceuticals, polymers, textiles, brewing materials, petroleum hydrocarbons, pulp and paper, as well as for medical analysis, and environmental analysis (e.g. soil, aquatic sediments, bio-solids such as manures and compost) (Malley and Martin 2003). In recent years great advances have been made in using near infrared technology to investigate soil properties (Cozzolino *et al*, 2013).

An NIR reflectance spectrum represents a composite of all the optical information of the outer layer (a few millimeters thick depending on the surface and structure composition) of a substance (Ozaki et al, 2007). This complex spectrum, which is rich in information, can be interpreted on a basis of chemical and physical composition (Workman and Shenk 2004). NIRS is based on the interaction of near-infrared radiation with soil constituents particularly the covalent bonds of small atoms such as O, C, H and N, abundant in organic matter (Ozaki et al. 2007). It has the potential to be a rapid technique if it is properly calibrated (Kusumo et al, 2008). Developing robust calibration model is the key success of NIRS technology application. Using multivariate analysis, such as partial least square regression (PLSR), the spectral and reference data can be proceeded for the calibration model development to characterize and quantify soil constituents (Workman and Shenk 2004).

One of the earliest NIRS successes in soil science was the successful determination of soil water content (Dalal and Henry, 1986). Then, it has been used successfully for measurement of total C and N (Chang *et al*. 2002; Kusumo *et al*. 2008). The use of NIRS techniques was then extended to simultaneously measure other soil physical and chemical properties (Cozzolino and Moron, 2006). Most of the success of NIRS technique is for measurement of total C, organic C, total nitrogen (N), cation exchange capacity (CEC) and soil moisture content (Stenberg et al, 2010). This technique later is expanded to measure root density (Kusumo *et al*. 2009; 2010; 2011), soil fertility (Genot *et al*, 2011), soil pH (Tekin *et al*, 2013), biochar stability indices (Kusumo *et al*. 2014) and in more recent year for soil structural quality assessment (Askari *et al*, 2015). Mapping soil properties using NIRS has been reported by some workers (Minasny *et al*, 2013). It has been successfully used to map soil C and N (Kodaira and Shibusawa, 2013; Vagen and Winowiecki, 2013). While, Kodaira and Shibusawa (2013) have successfully map soil moisture content, organic matter, CEC, total C, ammonium N, nitrate N, total N, available P, and P absorptive coefficient, using NIRS.

Kayangan agricultural area in North Lombok is planned to become fruit and vegetables producer by North Lombok Government. Beside its suitability for fruit and vegetables, there is a high potential market for tourism area in Gili Trawangan, Gili Meno and Gili Air, which is quite close to the Kayangan area. Fruit and vegetables for the hotels and restaurants are supplied mostly from Bali and Java and some from Mataram (Lombok). These tourism destinations are very famous, thus massive number of international tourists visit these places every year to enjoy the beautiful beach and coral. Development of Kayangan area for agricultural use faces obstacle; it doesn't have soil nutrient map which can be use the basis of efficient fertilizer application. If we can map this area into several levels of nutrient status and then the fertilizer recommendation is based on the

status of each specific site, effective and efficient use of fertilizer will be obtained and this will support sustainable agriculture development. Because mapping soil properties using conventional methods is very expensive, so rapid and inexpensive technique (NIRS) is extremely needed.

From the above information, “development of rapid and cheap technique from soil reflectance in measuring and mapping soil carbon and nitrogen for fertilizer application” is undoubtedly needed. It is expected that effective and efficient use of fertilizer can be achieved, excessive use of fertilizer can be avoided, and leaching and negative impact of excessive fertilizer can be avoided.

2. Materials and Methods

2.1. Soil sample collection

Top soils (0-10 cm depth) from 305 points were collected using soil corer from study area of Kayangan North Lombok Indonesia, covering the total area about 2,986 ha. Soil corer with diameter 2.54 cm was used to collect the soil samples. When samples were collected, the position and altitude of each sample was recorded. The samples were put into plastic bags and put codes, then took to the laboratory for soil preparation.

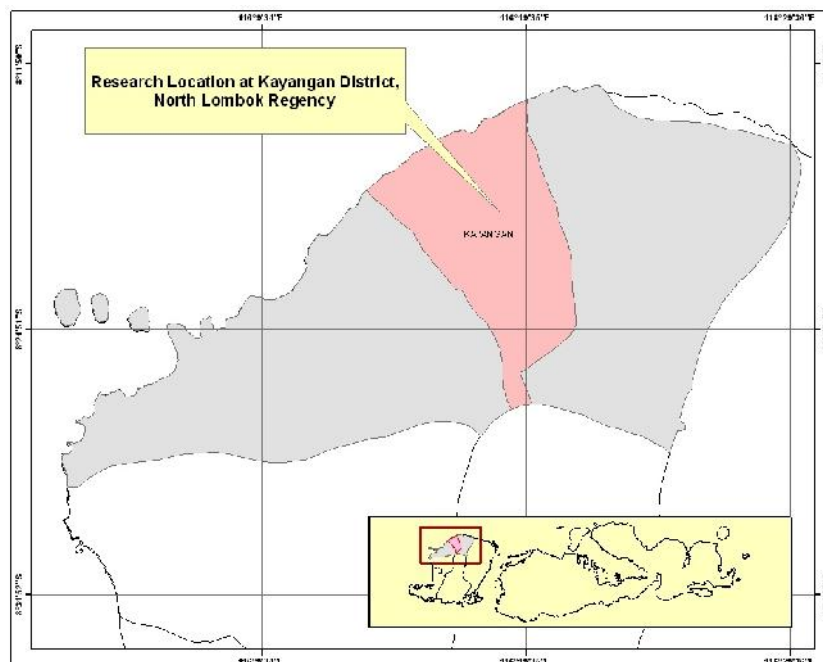

Figure 1. Map of Kayangan agriculture development area in North Lombok, and insert is the West Nusa Tenggara province.

2.2. Soil preparation and analysis

Soil samples were transported to laboratory which be then dried (air dry), ground and sieved to pass 0.2 mm diameter sieve. Part of each sample was analyzed for soil carbon (Walkley and Black method) and nitrogen (Kjeldahl method), then another part of each sample was scanned using Near Infrared Spectroscopy (NIRS).

2.3. Spectral acquisition and spectral pre-processing

Spectral reflectance (UV, visible and NIR range; 350 – 2500 nm) were acquired using a soil

contact probe (supplied by ASD) attached by fibre optic cable to the spectrometer–ASD FieldSpec 3 V-NIR Spectrometer (Analytical Spectral Device, Boulder, CO, USA). The spectrometer provides spectra from 350-2500 nm with 1 nm resolution. The spectral data were then imported to a software (ParLeS; Viscarra Rossel, 2008) for spectral pre-processing. The data underwent pre-processing steps namely: transformation to $\log(1/R) - R$, wavelet detrending, and smoothing using a Savitzky-Golay filter. The smoothed data were thereafter processed into the first derivative, and then finally treated using mean centring.

Principal component analysis (PCA)

The pre-processed spectral data were statically analysed using Principal Component Analysis (PCA). PCA transforms the correlated original variables into non-correlated new variables which have smaller dimensionality but can explain larger variations of the original data. PCA was conducted using ParLeS software (Viscarra Rossel, 2008). A score plot of the first two principal components, PC1 and PC2, which accounted for the greatest variance of the spectral data, is used to group the soil samples with very low, low, medium or high C and N content.

2.4. Developing calibration models

Partial Least Square Regression (PLSR) (ParLeS; Viscarra Rossel, 2008) was used to develop calibration models between the pre-processed spectral data and the reference analytical data of soil C and N. In order to avoid over fitting, the PLSR models are developed using a number of factors (principal components) that produce low root mean square error (*RMSE*) and low Akaike Information Criterion (*AIC*). Over fitting may happen when excessively large numbers of factors are applied. The calibration model was tested using one-leave-out cross-validation and using separate validation sample set.

2.5. Parameters for regression model accuracy

The ability of the PLSR model to predict soil C and N was assessed using the following statistics: (i) *RMSE* (root mean square error) of measured and predicted soil C and N, (ii) coefficient determination (R^2), and (iii) *RPD* (ratio of prediction to deviation); *RPD* is calculated as standard deviation of the reference data divided by root mean square error ($SD/RMSE$). The best prediction model has the largest *RPD* and R^2 , and the smallest *RMSE* in cross validation test or using separate validation test.

3. Results and Discussion

3.1. Soil Carbon and Nitrogen

The summary of selected properties of the soil samples is shown in Table 1. The range (min – max) of soil C and N is narrow, from very low to medium, with no samples containing high C and N. Low content of C and N in this soil is probably related to low return of organic matter and coarse soil texture. High oxidation rate in coarse soil texture tends to reduce the amount of soil organic matter. Moreover, soil with less clay has less ability to protect organic matter from oxidation process. Organic matter can be located among clay particles and thus be protected from organic decomposition.

Table 1. Soil sample properties

Property	Range		Median	Mean	Variance	Standard deviation	Coefficient of variation (%)
	Min.	Max.					
Soil C	0.39	2.28	1.01	1.03	0.092	0.304	29.45
Soil N	0.04	0.26	0.11	0.11	0.001	0.036	31.70

3.2. Soil Spectral Shape

The shape of soil spectral reflectance with very low (< 1% C), low (1-2% C) and medium (2-3% C) amount of carbon is shown in Figure 2. Soil with very low C has higher reflectance at around 750 nm compared to soils with low and medium C, showing brighter colour. Soil with higher C show lower reflectance (darker colour) at around visible band, indicating higher amount of organic matter. Soil with very low organic matter content has shaper angle at around 750 nm, compared to low and medium organic matter content. The same phenomenon was also found by Dematte et al, (2004) and Kusumo et al (2008).

As water (O-H bond) is the strongest absorber in the NIR region, its strong absorption can be seen at around 1400 and 1900 nm (Figure 2). Absorption at around 1400 nm is the first overtones of the O-H bond of water, while absorption at around 1900 nm is the combination of the H-O-H bend and O-H stretching (Clark, 1999). Strong absorption at around 2200 nm is combination of metal O-H bend plus O-H stretch.

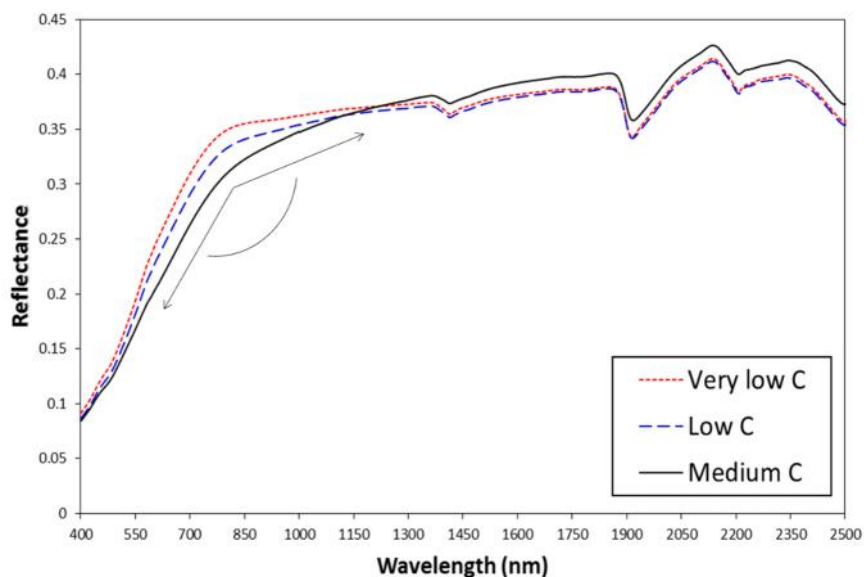

Figure 2. Spectral shape of soils with very low, low and medium amount of carbon.

3.3. Score Plot of Pre-processed Spectral Data

Score plot of the first two principal components was presented in Figure 3. Two dimensional score plot of the first two principal components containing 70.5% spectral variance were not clearly able to separate sample groups with very low (< 1%), low (1-2%) and medium (2-3%) content of C. Some samples of the three groups overlap one each other, although samples with higher C content tend to stay at upper position of quadran 1 and 2.

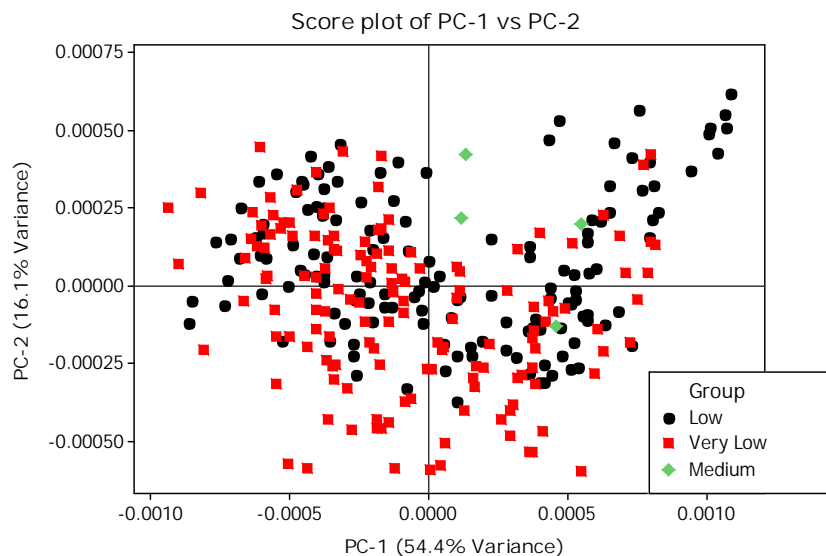

Figure 3. Score plot of the first two principal components which account for 70.5% variance of the spectral data

3.4. Prediction Accuracy of Soil C and N

Prediction values of soil C and N using leave-one-out cross-validation and using separate validation set are shown at Table 2. Prediction of soil C and N using PLSR calibration model produce moderate accuracy (RPD around 2.00). According to Chang et.al. (2001), the prediction values of soil properties with R^2 0.5-0.8 and RPD 1.4-2.0 are considered moderately successful. While Malley et. al. (2004) considered moderate accuracy if the R^2 0.7 – 0.8 and RPD 1.75 – 2.25. Some factors may cause moderate accuracy of near infrared prediction model, such as low accuracy laboratory analysis as the reference data, spectral outliers or both. Other chromophores (such as water, decomposition level of organic matter, clay and non-clay soil minerals, carbonates, iron oxides, particle size) may also influence the accuracy.

Table 2. Prediction values of soil C and N using leave-one-out cross-validation and using separate validation set.

Properties	Prediction values (leave-one-out cross-validation)		
	R^2_{cv}	RMSECV	RPD _{cv}
C Total	0.756	0.151	2.01
N Total	0.753	0.017	2.00
	Prediction values (separate validation set)		
	R^2	RMSE	RPD
C Total	0.763	0.149	2.01
N Total	0.742	0.017	1.98

Note: 10 factors (latent variables) used

Figure 4 shows the relationship between laboratory measured C (and N) and NIRS predicted C (and N). The data show moderate relationship between laboratory and NIRS analysis, with R^2_{cv} 0.75-0.76 and RPD_{cv} 2.00-2.01. Moderately useful measurement using NIRS indicates that this technique may be used to measure and map soil C and N in the Kayangan agriculture development

area North Lombok. Some previous researches also found moderate accuracy of C and N measurement using NIRS technique (Kusumo et al, 2008). The accuracy may be increased by using more sophisticated tools to analyse the samples (as the reference data) so robustness of the calibration model can be improved. The reference data produced using conventional analysis (Walkley and Black for C; Kjeldhal for N) might be not optimal to analyse the real amount of C and N total. Those methods have limitation on combusting all forms of C and N in soil. Some forms of C and N might be difficult to digest and still remain in soil in the solid fraction. Some previous researchers reported the the recovery of C and N combustion using those techniques was less then 80%.

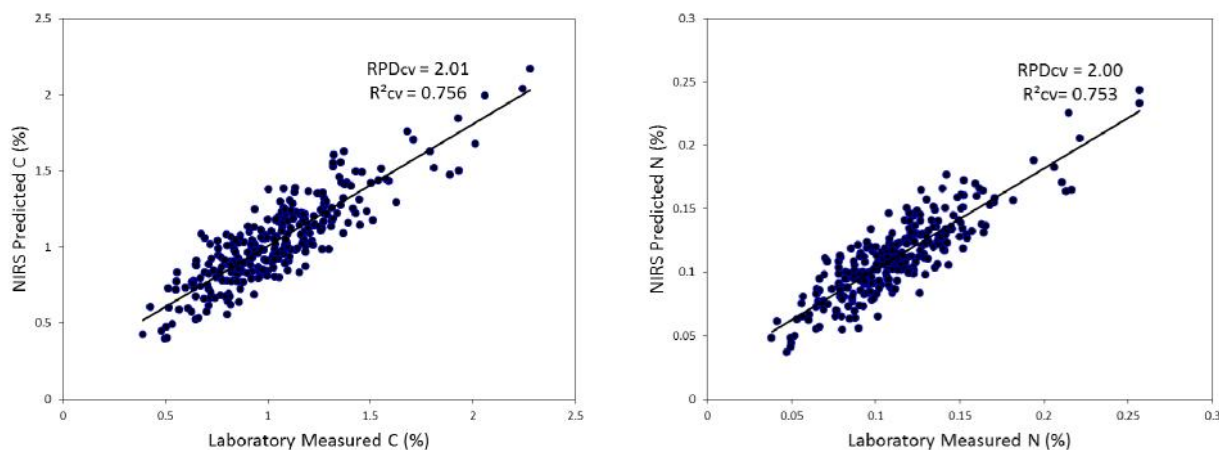

Figure 4. Relationship between laboratory measurement and NIRS prediction of soil C and N.

3.5. Mapping Soil Carbon and Nitrogen

Soil map based on laboratory analysis and NIRS analysis is shown in Figure 5. Although most of the areas contain very low and low soil C, the map can show the degradation of the soil C content from lower (brighter colour) to higher content (darker colour). From the map, it can be said that NIRS technique is useful for rapid measuring and mapping of soil C and N. Rather than spending very high cost for mapping soil C and N using standard expensive laboratory analysis, it may be more useful to save the cost although the accuracy of NIRS technique may sometimes be not excellent as standard laboratory analysis. Using NIRS, we can scan many samples from more dense sites with shorter distance of sample collection. From this method of sample collection we can produce better detail soil C (and N) map.

The successful effort of measuring and mapping soil C and N using NIRS technique will give benefit to other purposes. The map will be useful for site specific management including site specific fertilization. By having soil C and N map, the recommended fertilizer can be applied on the right places, where the area with low C and N should be added more organic matter and N fertilizer, and in the area with high C and N it should be added low organic matter and N, or it might be not temporarily needed additional fertilizer.

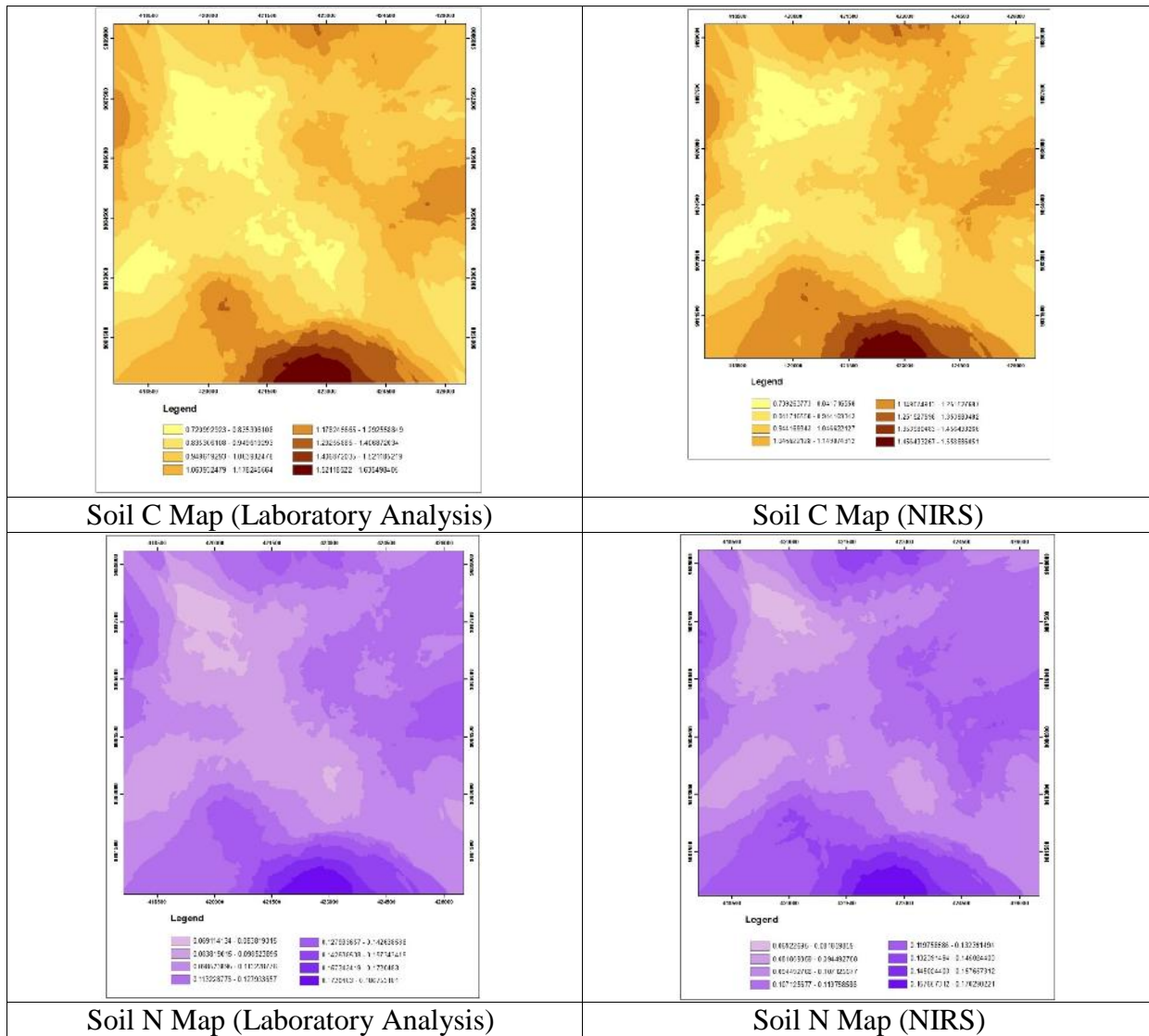

Figure 5. Distribution of soil carbon content on the study area of Kayangan North Lombok, Indonesia.

4. Conclusion

Near infrared spectroscopy technique was able to measure and map soil C and N di Indonesian Tropical Soil in Kayangan Area North Lombok with moderate accuracy. This technique is considered rapid because no chemicals needed and the process of scanning is very fast. The ability of this technique to map soil C and N may give benefit for site specific management including site specific fertilization which in turn may apply recommended fertilization and avoid excessive use of fertilizer. The accuracy of the PLSR model should be tested using reference data of soil C and N analysed using dry combustion technique (such LECO or Elemental Analysis).

References

- [1] Askari, M. S., J. Cui, S. M. O'Rourke and N. M. Holden (2015). "Evaluation of soil structural quality using VIS–NIR spectra." *Soil and Tillage Research* **146**: 108-117.
- [2] Clark, R. N. (1999). Spectroscopy of rocks and minerals, and principles of spectroscopy. Remote sensing for

- the earth science: Manual of remote sensing. A. N. Rench. New York, John Wiley & Sons. **3**.
- [3] Cozzolino, D. and A. Moron (2006). "Potential of near-infrared reflectance spectroscopy and chemometrics to predict soil carbon fractions." *Soil & Tillage Research* **85**: 78-85.
- [4] Cozzolino, D., W. Cynkar, R. Damberg, N. Shah and P. Smith (2013). "In situ measurement of soil chemical composition by near-infrared spectroscopy: a tool toward sustainable vineyard management." *Communications in Soil Science and Plant Analysis* **44**(10): 1610-1619.
- [5] Dalal, R. C. and R. J. Henry (1986). "Simultaneous determination of moisture, organic carbon, and total nitrogen by near infrared reflectance." *Soil Science Society of America Journal* **50**: 120-123.
- [6] Demattê, J. A. M., R. C. Campos, M. C. Alves, P. R. Fiorio and M. R. Nanni (2004). "Visible-NIR reflectance: a new approach on soil evaluation." *Geoderma* **121**(1/2): 95-112.
- [7] Genot, V., G. Colinet, L. Bock, D. Vanvyve, Y. Reusen and P. Dardenne (2011). "Near infrared reflectance spectroscopy for estimating soil characteristics valuable in the diagnosis of soil fertility." *Journal of Near Infrared Spectroscopy* **19**(2): 117.
- [8] Kodaira, M. and S. Shibusawa (2013). "Using a mobile real-time soil visible-near infrared sensor for high resolution soil property mapping." *Geoderma* **199**: 64-79.
- [9] Kusumo, B. H., C. B. Hedley, M. J. Hedley, A. Hueni, M. P. Tuohy and G. C. Arnold (2008). "The use of diffuse reflectance spectroscopy for in situ carbon and nitrogen analysis of pastoral soils." *Australian Journal of Soil Research* **46**: 623-635.
- [10] Kusumo, B. H., M. Camps Arbestain, A. Mahmud, M. J. Hedley, C. B. Hedley, R. Calvelo Pereira, T. Wang and B. P. Singh (2014). "Assessing biochar stability indices using near-infrared (NIR) reflectance spectroscopy." *Journal of Near Infrared Spectroscopy*: 22, 313-328.
- [11] Kusumo, B. H., M. J. Hedley, C. B. Hedley and M. P. Tuohy (2011). "Measuring carbon dynamics in field soils using soil spectral reflectance: prediction of maize root density, soil organic carbon and nitrogen content." *Plant and Soil* **338**(1-2): 233-245.
- [12] Kusumo, B. H., M. J. Hedley, C. B. Hedley, A. Hueni, G. C. Arnold and M. P. Tuohy (2009). "The use of Vis-NIR spectral reflectance for determining root density: evaluation of ryegrass roots in a glasshouse trial." *European Journal of Soil Science* **60**: 22-32.
- [13] Kusumo, B. H., M. J. Hedley, C. B. Hedley, G. C. Arnold and M. P. Tuohy (2010). "Predicting pasture root density from soil spectral reflectance: field measurement." *European Journal of Soil Science* **61**(1): 1-13.
- [14] Malley, D. F. and P. D. Martin (2003). The use of near-infrared spectroscopy for soil analysis. Tools for nutrient and pollutant management: Application to agriculture and environmental quality, Massey University, Palmerston North, New Zealand, Fertilizer and Lime Research Centre.
- [15] Malley, D. F., P. D. Martin and E. Ben-Dor (2004). Application in analysis of soils. Near-Infrared Spectroscopy in Agriculture, Agronomy Monograph no. 44. K. A. Barbarick, C. A. Roberts, W. A. Dick et al. Madison, Wisconsin, USA, American Society of Agronomy, Inc., Crop Science Society of America, Inc., Soil Science Society of America, Inc.: 729-784.
- [16] Minasny B., McBratney A. B., Malone B. P. and Wheeler I (2013). Digital mapping of soil carbon. *Advance in Agronomy* **118**: 1-47.
- [17] Ozaki, Y., S. Morita and Y. Du (2007). Spectral analysis. Near-infrared spectroscopy in food science and technology. Y. Ozaki, W. F. McClure and A. A. Christy. Hoboken, New Jersey, Wiley-Interscience, John Wiley & Sons, Inc.
- [18] Stenberg, B., R. A. Viscarra Rossel, A. M. Mouazen and J. Wetterlind (2010). "Chapter Five-Visible and Near Infrared Spectroscopy in Soil Science." *Advances in Agronomy* **107**: 163-215.
- [19] Stuart, B. (2004). Infrared Spectroscopy: Fundamentals and Application. Chichester, England, John Wiley & Sons.
- [20] Tekin, Y., B. Kuang and A. M. Mouazen (2013). "Potential of on-line visible and near infrared spectroscopy for measurement of pH for deriving variable rate lime recommendations." *Sensors* **13**(8): 10177-10190.
- [21] Vågen, T.-G. and L. A. Winowiecki (2013). "Mapping of soil organic carbon stocks for spatially explicit assessments of climate change mitigation potential." *Environmental Research Letters* **8**(1): 015011.
- [22] Viscarra Rossel, R. A. (2008). "ParLeS: Software for chemometric analysis of spectroscopic data." *Chemometrics and Intelligent Laboratory Systems* **90**: 72-83.

Correlation Between Waist/Hip Ratio And Lipid Profile Of Lactovegetarian Community In West Lombok

Ardiana Ekawanti^{1,*}, Agnes Ragil Rosano¹

¹ Medical Faculty Mataram University, Jl. Pendidikan No. 37 Mataram, West Nusa Tenggara

* Email: ekawantimuhaimin@gmail.com

Abstract

Central obesity and dyslipidemia are the risks of metabolic syndrome. Waist and Hip (W/H) ratio is early screening to diagnose of central obesity. Vegetarian diet decreased the risks of metabolic syndrome. Aim of this study was to find out the correlation of waist and hip ratio and lipid profile of lactovegetarian community in west Lombok. This research design was cross sectional study involving all community of lactovegetarian in west Lombok. There were 29 member of lactovegetarian community involved in this study. Anthropometric assessment conducted to find out W/H ratio and blood sample taken to assess lipid profile. Correlation of W/H ratio and lipid profile analysed by using Pearson correlation. The result for correlation of W/H ratio and lipid profile W/H ratio and cholesterol did not correlated (p 0.887) W/H ratio and triglyceride (p 0.632) W/H ratio and HDL (p 0.978) and W/H and LDL (p 0.862). That result can be concluded that W/H ratio did not correlated with lipid profile of lactovegetarian community.

Keywords: *vegetarian, anthropometric, waist/hip ratio, lipid profile*

1. Introduction

Vegetarian diet tends to be more popular all over the world, including Indonesia. In 1997, 1 % of American population were vegetarians, and in 2006 they were increased to 23 % of all population ^[1]. In India, more than 50% of population were vegetarian in 2003 ^[2]. Indonesia Vegetarian Society (IVS) documented that there are 5000 vegetarian in 1998 and these number were raised in 2007 to be 70.000 of vegetarian participants. In West Nusa Tenggara (WNT) vegetarians did not well-documented, IVS noted that most of vegetarian in WNT were lacto-vegetarian and lacto-ovo vegetarian ^[3].

Vegetarian diet has decreased the risk of some diseases such as hypertension, type 2-diabetes mellitus, cancer and metabolic syndrome ^{[4] [5] [6]}. Metabolic syndrome was syndrome which was including obesity, dyslipidemia, hyperglycemia and hypertension. This syndrome increased the risk of type 2- diabetes mellitus and cardiovascular disease ^[7]. Prevalent rate of metabolic syndrome was 15-30 % all over the world and the highest was in developing country ^[8].

Diet is one factor that affected the risk of metabolic syndrome ^{[9] [10]}. Study conducted by Adventist Health Study in America and Canada showed that vegetarian diet decreased risk of metabolic syndrome ^[5]. Study conducted by Diah ^[11] on vegetarian in Yogyakarta, Semarang and Surabaya indicated that the risk of metabolic syndrome of vegetarian vegan was not different significantly to difference vegetarian non vegan.

Some studies showed that metabolic syndrome increased by central obesity, while metabolic syndrome consist of dyslipidemia. Since the lactovegetarian has restricted in animal product diet, so that they consumed low containing fat. This condition would affected lipid profile of this community. The aimed of this study was to find out the correlation between WHR and lipid profile in lactovegetarian community.

2. Material and Method

2.1. Study Design

This research was an observational research using cross sectional study design. All parameters namely interview, anthropometric measurement (waist circumference and hip circumference) and lipid profile assessment conducted in one period of time. Dependent variable of this study was lipid profile, while independent variable was waist/hip ratio. This study was taken place in lacto vegetarian community in Gerung district in July and August 2015.

2.2. Research Participants

Participants in this study were the member of lacto vegetarian community which fulfill inclusion and exclusion criteria. Inclusion criteria were: member of lacto vegetarian community, agree to participate by signing informed consent, aged 18-64 year old. Exclusion criteria were: active smoker, alcohol consumption, pregnant, refuse to participate. Minimal sample size calculation by using proportion formulation found that number of minimal sample was 30. From 45 member of lactovegetarian community 30 member were enrolled and one person was excluded because of the age was under 18 year old.

2.3. Research procedure

Following the signing of informed consent, participants underwent research procedure. Waist circumference was measured by using WHO anthropometric guideline, that was in the middle of the line between arcus costae and crista iliaca and hip circumference was on m. gluteus maximus. Ratio of waist circumference and hip circumference then categorized into central obesity or not. Afterwards, 5 ml of blood sample were taken from v. mediana cubiti then spill out from disposable sput into plain sample tube (non-EDTA tube) to get blood serum. Serum then assessed for lipid profile by using automatic hemoanalyzer and the value was stated in mg/dL.

3. Result and Discussion

The result of this study was as follows:

Table 1. Participants characteristic of W/H ratio and lipid profile

Characteristic of participants	Value (mean±SD)
Waist to hip ratio	0.84±0.05
- Male	0.85±0.06
- Female	0.83±0.05
Lipid profile	
Triglyceride	176±128 mg/dL
- Male	201±157 mg/dL
- Female	156±100 mg/dL
Cholesterol	165±38 mg/dL
- Male	164±39 mg/dL
- Female	167±39 mg/dL
HDL	41±12 mg/dL
- Male	39±12 mg/dL
- Female	42±14 mg/dL
LDL	
- Male	92±35 mg/dL
- Female	84±46 mg/dL

The participants features from table showed that mean of W/H ratio was in normal limit, either male or female were not suffered from central obesity (male <90 cm and female <85 cm). Triglyceride value for male was higher than normal value. HDL value either male dan female were lower than normal value, while LDL and cholesterol within normal limit.

Since data were normal distribution statistically, so that appropriate statistical analysis for correlation testing was Pearson's correlation test. The Pearson's test result as below:

Table 2. Correlation between W/H ratio and lipid profile

	Pearson's Correlation (p,)			
	Triglyceride	Cholesterol	HDL	LDL
WHR	0.289;0.204	0.352; 0.179	0.583;0.106	0.999;0.000

Table 2 demonstrated that W/H ratio was not correlated significantly to triglyceride, cholesterol, HDL and LDL in lactovegetarian community. Waist/Hip ratio is one parameter which is useful to describe central or abdominal obesity in the population. Compare to all anthropometric measurement, W/H ratio was a sensitive parameter to assess the risk of cardiovascular diseases ^[12]. Based on the result of W/H ratio (WHR)of lactovegetarian population in West Lombok, founded that the risk of cardiovascular disease was lower than normal population since WHR value was lower than normal population, male <90 and female <85 (WHO, 2011). Regarding to this reference value 92 % of the lactovegetarian population had normal WHR, that meant this population has mild cardiovascular risk ^[12] (WHO, 2008). Study by Czernichow, et al (2011) ^[13] demonstrated that WHR was the best predictor of cardiovascular risk compared to other antropometric parameter in diabetes mellitus population and it could describe value of VLDL and LDL, the larger of WHR and the larger of VLDL and LDL value. The result of this research was different from Czernichow. Life style and underlying disease of the population affected lipid profile of the population.

Lipid profile which consist of triglyceride, total cholesterol, LDL and HDL in this study were not correlated to waist and hip ratio in lactovegetarian population. This result was the same as found by Gandhi, et al, 2014^[4]; Chaudri et, al. 2013 ^[15]; Jian et al, 2014 ^[16]; Verma, et at. 2015 ^[17]; Huang, 2014 ^[18].

4. Conclusion

Conclusion of this study was WHR in lactovegetarian community in West Lombok was normal and also most of lipid profile within normal limit, except HDL value was lower than reference value. WHR did not correlated to lipid profile in lactovegetarian community in West Lombok.

References

- [1] Key TJ, et.al. Health Effect of Vegetarian and Vegan Diets. *Proceedings of Nutrition Society*. 2006. Available from: www.ncbi.nlm.nih.gov/pubmed/16441942 . [Accessed 28th February 2015].
- [2] Kusharisupeni, A. Vegetarian Gaya Hidup Sehat Masa Kini. Andi Offset. Yogyakarta.
- [3] Rahayu PERS. Profil lemak pada vegetarian jenis Lacto-ovo di Mataram. Universitas Mataram. [Skripsi]. 2008.
- [4] Tonstad S, Nathan E, Oda K, et al. Vegan Diets and Hypothyroidism. *Am Nutrients Journal*.2013 Available from:<http://www.ncbi.nlm.nih.gov/pubmed/24264226> . [Accessed 20th February 2015].
- [5] Rizzo NS, Sabaté J, Jaceldo SK, et al. Vegetarian Dietary Patterns Are Associated With a Lower Risk of Metabolik Syndrome: The Adventist Health Study 2. *Diabetes Care Journal*, vol. 34 pp. 1225-1227. 2011. Available from: <http://www.ncbi.nlm.nih.gov/pmc/articles/PMC3114510/>. [Accessed 20th

- February 2015].
- [6] Pettersen BJ, Anousheh R, Fan J, et al. Vegetarian Diets And Blood Pressure Among White Subjects: Results From The Adventist Health Study-2 (AHS2). *National Institutes of Health*. 2012. Available from: <http://www.ncbi.nlm.nih.gov/pubmed/22230619>. [Accessed 7th March 2015].
- [7] Soegondo S, Purnamasari D. Sindroma metabolik. Dalam : Sudoyo AW, Setiyohadi B, Alwi I, Simadibrata M, Setiati S, editors. Buku Ajar Ilmu Penyakit Dalam Ed.5. Interna Publishing: Jakarta. 2009
- [8] Cameron AJ, Zimmet PZ, Alberti KG, et al. The metabolik syndrome as a predictor of incident diabetes mellitus in Mauritius. *Diabet Med J, No. 24 (12)*. 2007 Available from: <http://www.ncbi.nlm.nih.gov/pubmed/17976203>. [Accessed 15th March 2015]
- [9] Amanda JB, Terry C, Christine M. Dietary patterns and metabolik syndrome - a review of epidemiologic evidence. *Asia Pacific Journal Of Clinical Nutrition, Vol. 15(2), pp. 134-142*. 2006. Available at: <http://espace.library.uq.edu.au/view/UQ:79858> [Accessed 15th March 2015].
- [10] Pamela LL, Lyn MS, June S. Dietary Intake and the Development of the Metabolik Syndrome. *Circulation Journal, vol. 117 pp. 754-761*. 2008. Available from: <http://circ.ahajournals.org/content/117/6/754.full> [Accessed 15th March 2015].
- [11] Diah Ari Setyorini. Perbedaan Sindroma Metabolik Pada Wanita Vegetarian Tipe Vegan dan Non Vegan. Semarang University. 2012
- [12] WHO. 2008. Waist Circumference and Waist-Hip Ratio: Report of WHO Expert Consultation. Geneva, WHO
- [13] Czernichow, et al. Comparison of WHR and other Obesity Indices as Predictor of CVS risk in people with type 2 diabetes. *Eur J Cardiovasc Prev Rehabil*. 2011 Apr 18(2): 312-319
- [14] Gandhi P, Agrawal N, Sharma S. 2014. A Study of Vegetarian Diet and Cholesterol and Triglycerides Levels. *Indian Journal of Applied Science* vol.4 .
- [15] Chauduri A, Borade NG, Bandopadhyayi, Hazra SK, Saba S. 2013. A Comparative Study of Lipid Profile and Autonomic Function in Vegetarian and non-vegetarian postmenopausal women. *Medical Journal of Dr. D.Y.Patil University*.
- [16] Jian ZH, Chiang CY, Lung CC, Ho CC, Ko PC, Nfor ON, Chang HC, Liaw YC, Liang YC, Liau YP. 2014. Vegetarian Diet and Cholesterol and TAG levels by Gender. *Public Health Nutrition*: 18(4), 721-726
- [17] Verma M, Verma P. 2015. Comparative Study of Lipid Profile Levels in Vegetarian and Non-Vegetarian Person. *IJLSSR* vol.3
- [18] Huang YW, Jian ZH, Chiang CY, Lung CC, Ho CC, Ko PC, Nfor ON. 2014. Vegan Diet and blood lipid profiles: a cross sectional study of pre and postmenopausal women

Isolation of Andrographolide from *Andrographis paniculata*

Aliefman Hakim^{*}, Dwi Laksmiwati, I Nyoman Loka, Sarifa Wahida Al Idrus,
Try Setyaningsih, Supriadi

Study Program of Chemistry Education, University of Mataram
Majapahit street 62, Mataram-Lombok 83125, Indonesia
Email: Aliefmanhakim27@gmail.com

Abstract

Andrographolide has been isolated from the methanol extract of *Andrographis paniculata*. Isolation is done by maceration and recrystallization. Isolated andrographolide used this method that has high amount (> 5% of the total extract). Andrographolide are identified using spectrum data of NMR, IR, and UV. Andrographolide can be further utilized for natural product material for synthesis, bioactivity studies, or chemotaxonomic studies. Andrographolide has been produced in large quantities and commercialized through the Calon Perusahaan Pemula Senyawa standar Indonesia (CPPBT-SSI) cooperation of Ristekdikti with Mataram University.

Keywords: Isolation, andrographolide, *Andrographis paniculata*

1. Introduction

Secondary metabolites are organic compounds derived from plants that produced not through the main metabolic pathways (Hakim, 2016). In general secondary metabolites have bioactive activity. Secondary metabolites are tasked to protect plants from pests and diseases, both from the plant itself or the surrounding environment. Secondary metabolites is only produced in small amounts. Some examples of classes of compounds that are included in the category of secondary metabolites namely terpenoids, steroids, polyketides, phenyl propanoid, flavonoids, and alkaloids (Hakim, *et al.*, 2016a). The main characteristics of secondary metabolites found in plants namely (1) have ecological functions like towing insects, protective, tools to compete, hormones, (2) unevenly distributed in every organism, (3) physiology activity related to chemical structure and relationships between structure.

Isolation of secondary metabolites from medicinal plants examined in natural product laboratory (Hakim, *et al.*, 2016b). Generally isolation of secondary metabolites consists of extraction, fractionation, purification, and elucidation structure of secondary metabolites. The same secondary metabolites from a plant species can be isolated in a various ways, so there is no standard procedure to isolate the secondary metabolites of a plant species. These isolation activities provide opportunities for students to design their own experiment (Hakim, *et al.*, 2016a). The discovery of secondary metabolites isolation procedures are simple and inexpensive will provide opportunities availability of secondary metabolites in significant amounts. In this article will describe the isolation procedure andrographolide from *Andrographis paniculata*.

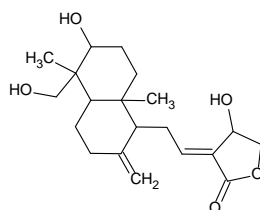

Figure 1. Structure of andrographolide

1.1. *Andrographis paniculata*

Andrographis paniculata Nees. (Bitter) is the annual plant that belongs to the family Acanthaceae (Sulistijo and Pujiasmanto, 2007). *A. paniculata* are upright, grows naturally in lowland areas to a height of ± 1600 m above sea level. *A. paniculata* are grown in a variety of habitats, such as the suburbs of fields, gardens, or forests. The main components of *A. paniculata* is andrographolide useful as medicine. In addition leaf of *A. paniculata* contains saponins, tannins, flavonoids (Taiz and Zeiger, 1991). Other chemical constituents present in the leaves and stems of *A. paniculata* are lactone, paniculin, and calmegin. Traditionally *A. paniculata* has been used for the treatment of snake or insect bites, fever, dysentery, rheumatism, tuberculosis, gastrointestinal infections, and others. *A. paniculata* is also used for antimicrobial/antibacterial (Yusron *et al.*, 2005).

Currently *A. paniculata* widely studied to be developed as a raw material of modern medicine, including the use of bitter as infection medicine. *A. paniculata* widely used topically as skin infections, rashes, sores, mange, open wounds and minor burns light. In addition *A. paniculata* is also widely used to treat of diabetes. All parts of *A. paniculata* such as leaves, stems, flowers and roots was eaten or boiled to drink (Pujiasmanto, *et al.*, 2007). The bitter taste is caused by the presence of andrographolide compounds that are numerous in the bitter plant especially in the leaves and stems. Andrographolide content in the leaves of 2.5 to 4.8% of the dry weight *A. paniculata*. Andrographolide is a diterpene lactone compound and soluble in organic solvents (Srijanto *et al.*, 2012).

Andrographolide has many benefits in health. Andrographolide has a variety of pharmacological activities such as lowering blood sugar levels, triglycerides, and LDL, anti-inflammatory, antioxidant, and analgesic. In addition Andrographolide also used as an antibacterial (Wardiatini *et al.*, 2014). This article will discuss the method of isolation andrographolide effectively and inexpensively.

2. Result and Discussion

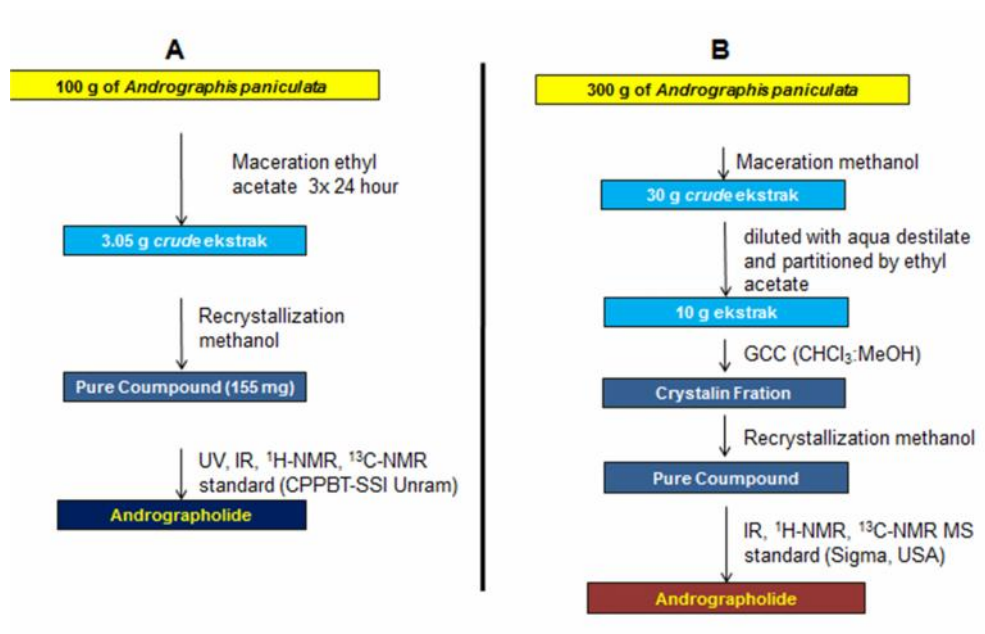

Figure 2. Comparison of isolation procedure of andrographolide

A = This reseach, B = Sukardiman *et al.*, (2007)

The used materials in this study consist of the andrographolide standard (CPPBT-SSI Mataram University), leaf of *A. paniculata*, ethanol, n-hexane, ethyl acetate, distilled water, methanol and TLC plate. The used tools in this study consist of a set of tools of maceration, filter paper, rod, plate, and a rotary evaporator.

A total of 100 gr of powder *Andrographis paniculata* was macerated with ethyl acetate 3x24 hours. Obtained extract were collected and evaporated with a rotary evaporator until it is condensed extract (3.05 g). Viscous extract were then recrystallized using hot methanol several times to obtain a yellowish white crystal (155 mg). These crystals were tested for purity using three systems eluent namely ethyl acetate: acetone (8: 2) ($R_f = 0.7$); chloroform 100% (0.6); ethyl acetate 100% (0.5). The structure of pure isolated coumpound were determined based on the spectroscopy data like NMR, UV, IR and confirmed using andrographolide standard (CPPBT-SSI Mataram University) by TLC standards and isolates on the same TLC plate and taking the value of the standard and isolates R_f spot. The results of spectroscopic data and R_f standard compound showed that isolated coumpound was andrographolide.

Isolation procedures of andrographolide from *A. paniculata* previously been published by Sukardiman *et al.* (2007). Comparison of andrographolide isolation procedures performed in this study and reference (Sukardiman *et al.*, 2007) is shown in Figure 2. It is seen that Sukardiman *et al.* (2007) procedures of isolation of andrographolide from *A. paniculata* in six steps, whereas isolation procedures performed in this study through four steps. Sukardiman *et al.* (2007) conducted a total extract fractionation using Gravity Coloum Chromatography (GCC) using CHCl_3 :MeOH as eluent. Results of fractionation was purified using recrystallization with methanol to produce andrographolide. On the other hand this study directly was recrystallization of total extract of *Andrographis paniculata* using hot methanol to produce andrographolide. Based on the above explanation andrographolide isolation procedures performed in this study is simpler than the andrographolide isolation procedure been published previously (Sukardiman *et al.*, 2007). Isolated andrographolide used procedures performed in this study that has high amount (> 5% of the total extract). Andrographolide can be further utilized for natural product material for synthesis, bioactivity studies, or chemotaxonomic studies. Andrografolida has been produced in large quantities and commercialized through the Calon Perusahaan Pemula Senyawa standar Indonesia (CPPBT-SSI) cooperation of Ristekdikti with Mataram University.

Acknowledgements

We wish to thank Direktorat PPBT, Kementerian Riset, Teknologi, dan Pendidikan Tinggi for financial support of this research in CPPBT programe No 32/PPK/F4/PKS.CPPBT/IX/2016 and No: 316.A/SPP-CPPBT/UN18.12/PL/2016.

References

- [1]. Hakim, A. (2016). Meningkatkan kualitas pembelajaran kimia bahan alam melalui praktikum. Arga Puji Press. Mataram
- [2]. Hakim, A., Liliyasi, Kadarohman, A., Syah, Y.M. 2016a. Making a Natural Product Chemistry Course Meaningful with a Mini Project Laboratory. *J. Chem. Educ.*, 93 (1), 193–196.
- [3]. Hakim, A., Liliyasi, Kadarohman, A., Syah, Y.M. 2016b. Effects of the Natural Product Mini Project Laboratory on the Students Conceptual Understanding. *Journal of Turkish Science Education*. 13 (2), 27-36.
- [4]. Pujiasmanto, B., J. Moenandir, S. Bahri, and Kuswanto. 2007. Kajian Agroekologi dan Morfologi Sambiloto (*Andrographis paniculata* Ness) pada Berbagai Habitat. *Biodiversitas* 8 (4):326-329
- [5]. Srijanto, B., Olivia, B.P., Lely, K., Eriawan, R. & Sriningsih. 2012. Pemurnian Ekstrak Etanol Sambiloto (*Andrographis paniculata* Ness) dengan Teknik Ekstraksi Cair-cair. *Prosiding InSin*as 0096.
- [6]. Sulistijo, T. D., dan B. Pujiasmanto. 2007. Identifikasi Sambiloto (*Andrographis paniculata* Ness) sebagai

- Dasar Pemanfaatan dan Pelestarian Plasma Nutfah. Biodiversitas 8 (3): 218 – 222
- [7]. Taiz, L. and E. Zeiger. 1991. Plant physiology. The Benjamin/Cummings Publ. Com., Redwood City. 565-568
- [8]. Wardiatini, N.K., Widjaja, I.N.K. & Noviyanti, N.W.R. (2014). Isolasi Andrografolid dari *Andrographis paniculata* (Burm. f.) Ness menggunakan Metode Purifikasi dan Kristalisasi. Jurnal Farmasi Udayana, Vol.III (1): 31-34.
- [9]. Yusron M, M. Januwati M, E. R. Pribadi. 2005. Budidaya tanaman sambiloto. Balai Penelitian Tanaman Obat dan Aromatika. Badan Penelitian dan Pengembangan Pertanian . Bogor.

The Use of 1-Mcp: Overview Several Studies on The Postharvest Quality of Selected Fruits

Liana Suryaningsih B.¹, John K. Fellman², James P. Mattheis³, Xisheng Sun⁴

^{*1}*Faculty of Agriculture, University of Mataram, 83125. Nusa Tenggara Barat Province, Indonesia*

²*Department of Horticulture and Landscape Architecture, Washington State University, Pullman, WA 99164-1030, USA*

³*USDA, ARS Tree Fruit Research Laboratory, Wenatchee, Washington, USA*

⁴*AgroFresh Inc. China. R&D Manager for Asia*

**Email: liana_suryanings@wsu.edu (Mobile: +6282146193080)*

Abstract

Several studies in using 1-methylcyclopropene (1MCP) to the postharvest quality of some selected fruits have been done within 2010-2015 period at some different places. 1-MCP has effectively inhibited the production of ethylene and maintained the firmness on 'Royal Gala' apples stored at controlled atmosphere for 4 months; suppressed the carbondioxide on 'Cavendish' bananas for 8 days under controlled atmosphere storage; and maintained the firmness on 'Kayu' and 'Raja' bananas at ambient temperature.

Keywords: *1-methylcyclopropene, carbondioxide, ethylene, firmness*

1. Introduction

1-methylcyclopropene (1-MCP), an inhibitor of ethylene perception, is increasingly used to improve storage potential and to maintain quality of vegetables and fruits (Curry, 2008; Watkins, 2008). 1_MCP shows promise as commercial control of ripening and senescence of harvested fruits and vegetables (Boonyarithongchai et al., 2010; Watkins, 2008). Overview several studies using 1-MCP on the postharvest quality of selected fruits is the objective of this research.

2. Materials and Method

2.1 Apple

'Royal Gala' apples harvested at three different maturities were treated with 1 ppm of 1-MCP for 15 hours and were stored for 4 months under CA storage. Quality assessment was done at day 1 and day 7 after storage.

2.2. Banana

'Cavendish' bananas were treated with 350 ppb of 1-MCP for 18 hours and were stored for 11 days under CA storage. The CO₂ production were assessed everyday during storage.

'Raja' and 'Kayu' bananas harvested at three different maturities were treated with 0.1114 gram of 1-MCP for 20 hours and stored for 7 days at ambient temperature. Quality assessment was done at day 1, 5 and 7.

3. Results and Discussion

3.1 'Royal Gala' Apples

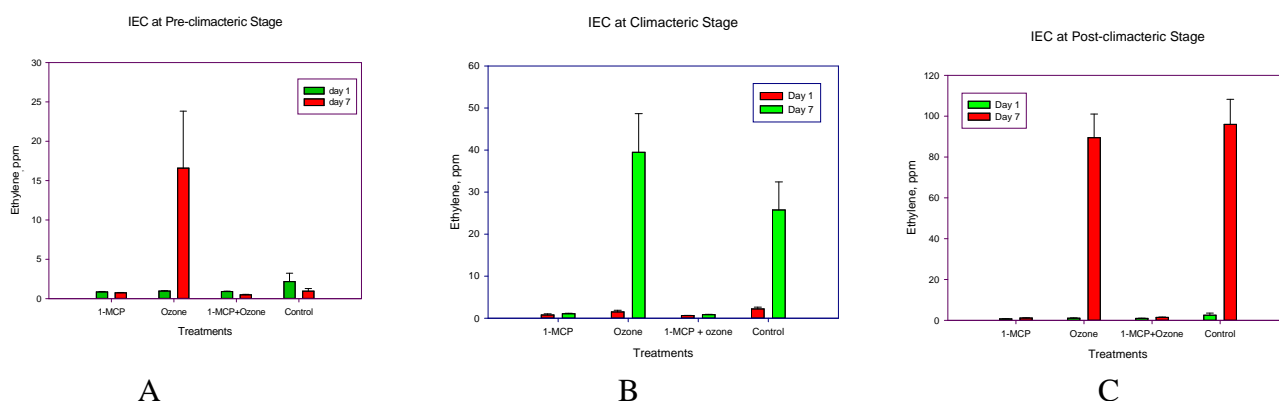

Figure 1. A: The internal ethylene concentration (IEC) for day 1 and day 7 after storage at pre-climacteric stage; B: The internal ethylene concentration (IEC) for day 1 and day 7 after storage at climacteric stage; C: The internal ethylene concentration (IEC) for day 1 and day 7 after storage at post-climacteric stage.

Results showed that 1-MCP effectively hampered the internal ethylene production (IEC) during storage at all maturity stages at day 1 after storage and continued to day 7 after storage.

3.2. 'Cavendish' Bananas

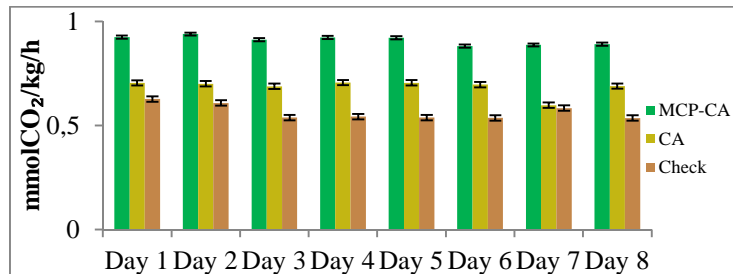

Figure 2. The CO₂ production for all treatments during storage.

As shown on figure 2, treatment with 1-MCP effectively increased the production of CO₂ which lead to the ability of 1-MCP to delay ripening on bananas.

3.3. 'Kayu' Bananas

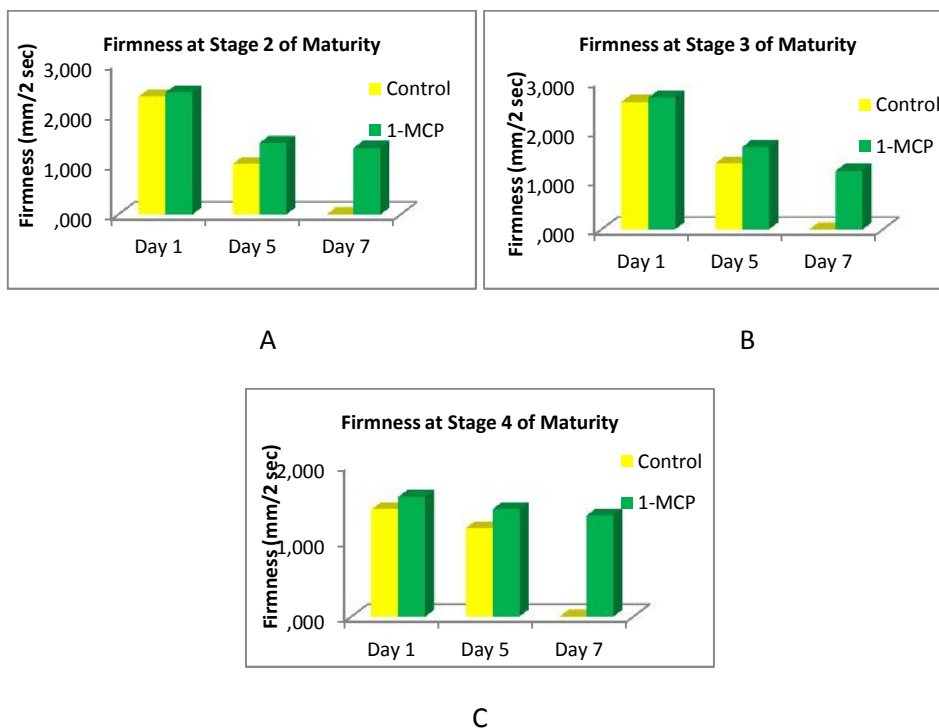
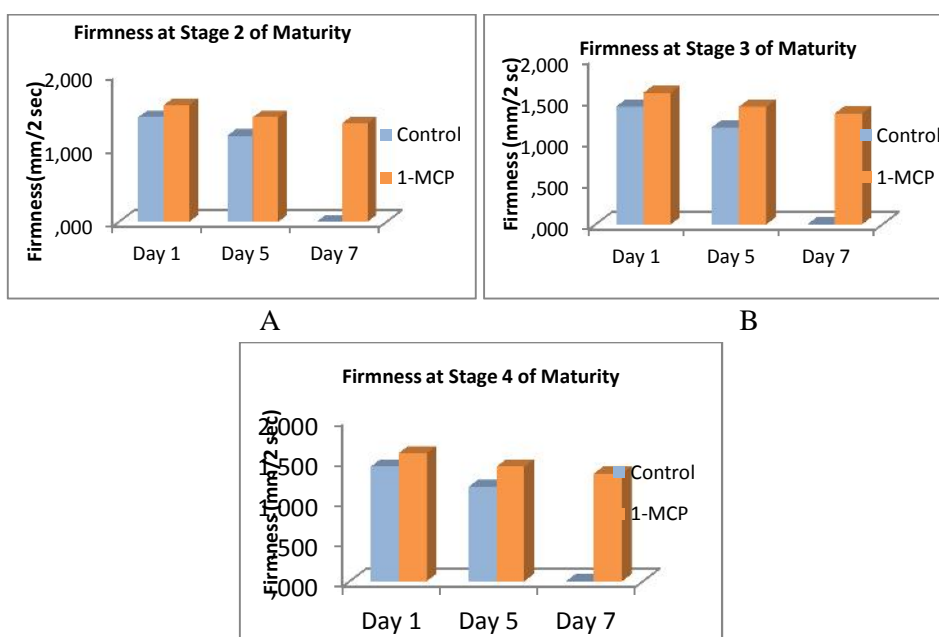

Figure 3. A: Firmness at day 1, 5, and 7 at stage 2 of maturity; B: Firmness at day 1, 5, and 7 at stage 3 of maturity; C: Firmness at day 1, 5, and 7 at stage 4 of maturity.

The use of 1-MCP on 'Kayu' bananas maintained the firmness better than untreated fruits at all stages of ripening.

3.4. 'Raja' Bananas



C

Figure 4. A: Firmness at day 1, 5, and 7 at stage 2 of maturity; B: Firmness at day 1, 5, and 7 at stage 3 of maturity; C: Firmness at day 1, 5, and 7 at stage 4 of maturity.

Figure 4 also showed the similar results that the use of 1-MCP on 'Raja' bananas maintained the firmness better than untreated fruits at all stages of ripening.

4. Conclusion

1-MCP not only inhibited the ethylene and CO₂ production, yet also maintained better firmness during and after storage on several selected fruits

References

- [1] C. B. Watkins, *Overview of 1-Methylcyclopropene Trials and Uses for Edible Horticultural Crops*, HortScience
- [2] E. Curry, *Effects of 1-MCP Applied Postharvest on Epicuticular Wax of Apples (*Malus domestica* Borkh) During Storage*, Journal of the Science of Food and Agriculture, 88:996-1006, 2008.
- [3]. P. Boonyaritthongchai and S. Kanlayanarat, *Effect of 1-MCP Treatment on the Postharvest Quality of Banana Fruit 'Kluai Kai'*, Acta Hort, 877, ISHS 2010.

Design Of The Measuring Instrument Of Turbidity Level Using Turbidity Sensor Based on SMS Gateway

Lily Maysari Angraini¹, Laili Mardiana^{1,*}, Kasnawi Al Hadi¹, Eka Ahmawati¹

¹*Physics Departement, Mathematics and Science Faculty, Universitas of Mataram, Jalan Majapahit 62 Mataram 83125*

**E-mail : lailimardiana@unram.ac.id*

Abstract

Ideal clean water must meet the water quality requirements which have been given by government. The presence of contaminants / impurities can cause turbidity and disturb water quality. Measurement of turbidity levels are generally still conventional in certain period. Therefore, the device which capable to measure turbidity level in real time and continuously are needed. This study aimed to design a turbidity level device based SMS gateway and find out the testing result of the device. The method used is hardware design using ATmega328 microcontroller on the Arduino Uno module. The components used are GSM Shield module to send SMS information, data logger system which is equipped with a RTC (Real Time Clock) for data storage along with time data information, and Turbidity Sensor TSD-10 as a detector. Whereas the design of software used Arduino IDE software as editor. The calibration process is done by comparing the value of the standard measuring instrument with value of sensor readings. It aimed to get linearity equation which will be used in the unit conversion process.

Keywords : *turbidity, SMS gateway, turbid meter, turbidity sensor*

I. Introduction

Water is one of the very important natural resource in the world. Water is a major component in the process of living creatures. Water is needed by living things not just to meet daily needs, but also as a means of transport, for industrial use, as a source of energy, agriculture and other purposes. Based on the role that is vital for life, then the required availability of water in good condition, both quality and quantity. The water is of poor quality will have an impact on the environment and the health of humans and other living things. The decline in water quality will degrade efficiency, productivity and the carrying capacity of water resources. Water pollution is generally derived from domestic sources and non-domestic sources. These pollutants affect water quality and cause turbidity in water.

Turbidity (turbidity) is a state where a liquid is reduced transparency due to the insoluble substances (ISO 1999). There are three aspects that affect turbidity, including aspects of physical, chemical and biological aspects aspects. Water turbidity level will generally be determined by the amount of NTU (nephelometric turbidity units). Magnitude turbidity of drinking water that meets the health requirements applicable by reference is not more than 5 NTU and not perceivable turbidity of the water will not be seen.

One standard test equipment to determine the level of turbidity is Turbidimeter. This tool is already common and easily searchable. But the price is relatively expensive, so only certain parties who have it. The design of the measuring instrument turbidity levels have also been carried out by some previous researchers. However, only limited research conducted to determine the level of turbidity and not many are using communications-based information systems.

This is why the authors to design a tool instrumentation capable of measuring the

level of water turbidity effectively and accurately using the Turbidity Sensor-based SMS Gateway and to know the test results of these sensors. In this study, the testing process is done with a case study on the Ancar river, in Mataram .

2. Theory

2.1. Turbidity sensor type TSD-10.

This sensor measures the amount of light coming from a light source (diode) to the light receiver (phototransistor) in order to calculate the water turbidity level.

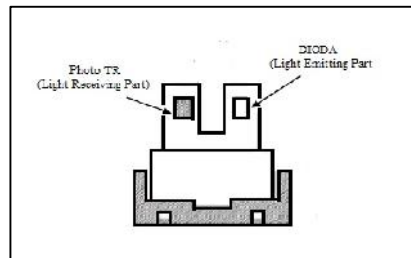

Figure 1.1 Parts of turbidity sensor (Source: www.ge-mcs.com)

There are two main components of the sensor circuit that changes the light intensity of the phototransistor and a light emitting diode (LED). Phototransistor generates a current in the base area. Countercurrent to the phototransistor is controlled by the amount of light or infrared received. While the LED is a semiconductor PN junction that emits light when fed forward Retainer . N-type semiconductor has a number of free electrons. While the P-type semiconductor has a number of free holes. If the N and P type semiconductors will be connected to form an energy barrier (junction) (Wahyudi, 2012).

2.2. Mikrokontroler Atmega 328

Arduino Uno is a microcontroller-based ATmega328 is a platform that is open source. Arduino has managed to write a program, compile it into binary code and upload it to the microcontroller memory.

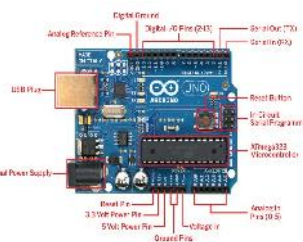

Figure 1.3 Arduino uno (Source: www.arduino.cc)

2.3. Icomsat GSM/GPRS Shield

Icomsat is a GSM / GPRS shield arduino whose main components are SIM900 Quad-band GSM / GPRS module. The use of this Icomsat done via AT commands (AT commands), and can be integrate with Arduino / Itarduino and Mega. Arduino to communicate and send commands to the GSM shield through serial communication.

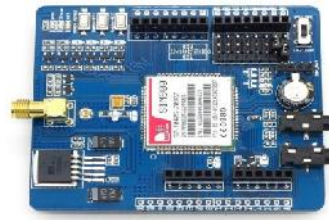

Figure 1.4 Icomsat GSM / GPRS Shield (Source: www.arduino.cc)

To be able to connect to the Internet network, Icomsat require the current GSM cards. APN settings, username and password entered on the card arduino sketch. Arduino and GSM shield can perform two-way communication, providing data on GSM arduino shield to be sent and GSM shield provide response data to arduino.

2.4. RTC (*Real Time Clock*)

Real Time Clock (RTC) serves as an information provider time (date and time) for the microcontroller. Time data is transferred from the RTC to the microcontroller via I2C interface. RTC can count the seconds, minutes, hours, day, date, month and year are valid until 2100.



Figure 1.5 RTC module (Source: www.sfe-electronics.com)

3. Methods

System design in this study consists of two parts, namely the design of the system hardware and software system design.

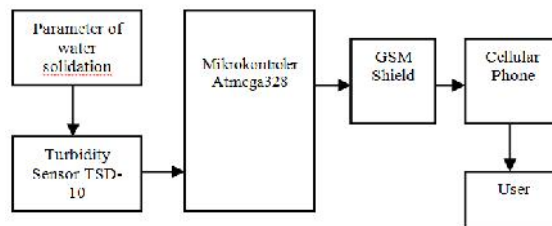

Figure 2.1 The flow of the whole system work process

3.1. Hardware Design Techniques

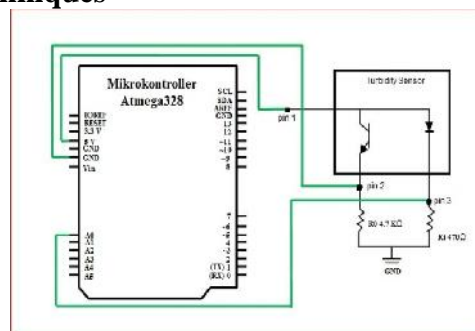

Figure 2.3 Hardware design tools

3.2. Mechanical Design Software

Software design is done by making use software Sketch arduino Arduino IDE shown in Figure 2.4.

3.3. Mechanical Testing Equipment

The samples are orange solution made with different concentrations, namely 7.5%; 10%; 12.5%; 15%; 17.5%; 20%; 22.5%; 25%; and 27.5%. In this process, the sensor displays the results in the form of voltage values with the unit mV. The results obtained will be compared with the results of measurements using standard tools Turbidimeter in units of NTU. From the comparison results will be obtained graph the linearity between the value of the voltage (mV) and turbidity (NTU), and the regression equation

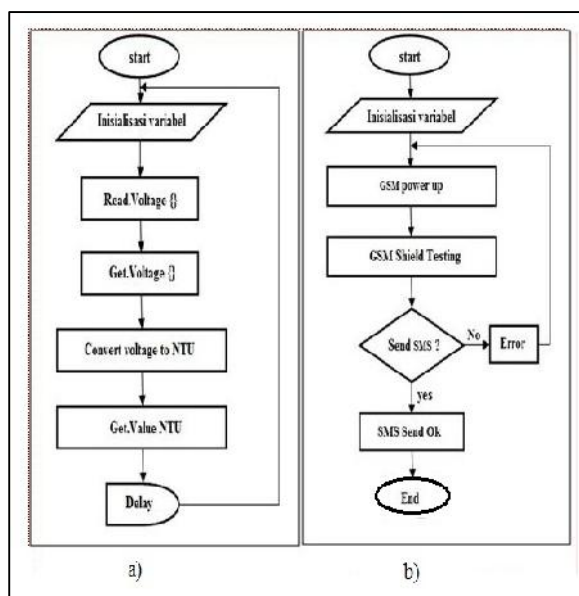

Figure 2.4 Flow Chart of the system, a) flow chart data system, b) flow charts GSM Shield

3.4. Mechanical Calibration

The calibration process is done by comparing the measurement results with the level of turbidity Turbidimeter standard tools and tools in the wake. The results obtained are the sensitivity values. Because the second unit of measurement tools are different, the data processing is done to determine the regression equation which could then be used as a reference for conversion into an NTU. Following the transfer function is generate

$$y = a + bx \quad (2.1)$$

3.5. Data Retrieval Techniques

The data retrieval process starts by uploading a program using the Arduino software. The program gives a chance to send information via SMS (Short Message Service). Data taken at 5 points Ancar Mataram river region.

4. Results and Discussion

A. Results of System Design

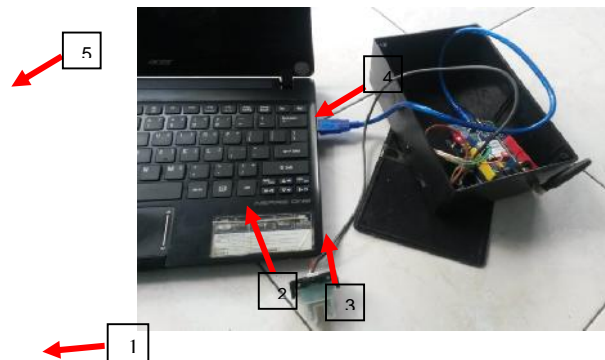

Figure 3.1 overall tool set consisting of 1) Turbiditi Sensor, 2) GSM Shield and Arduino, 3) Antenna, 4) cable downloader, 5) PC .

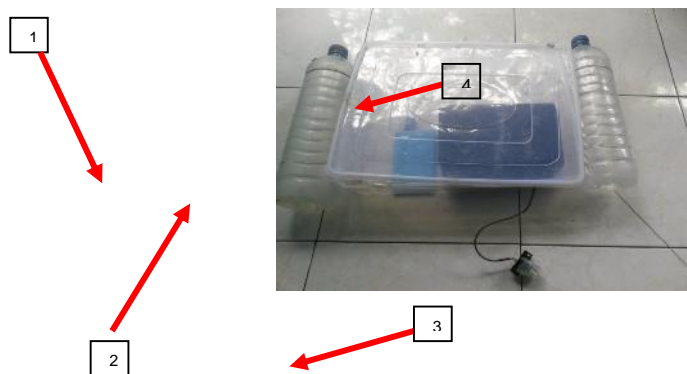

Figure 3.2 System measuring tool is ready tested, 1) power bank, 2) system tools, 3) Turbidity Sensor, 4) buoys

4.2. System Testing Results

The testing phase system is divided into two, namely Turbidity sensor testing and system testing SMS Gateway

1) Testing Results Turbidity Sensor TSD-10

a. Calibration Unit Con

Table 3.1 Results of measurement using a turbidimeter and turbidity sensors

concentration solution (%)	Turbidimeter (NTU)	Sensor (mV)
7,5	169	3440,86
10	221	3391,98
12,5	293	3225,81
15	359	3103,62
17,5	447	2971,65
20	517	2903,23
22,5	605	2771,26
25	668	2595,31
27,5	711	2580,65

From the data in Table 3.1 regression equation which could then be used as a reference

for conversion into an NTU.

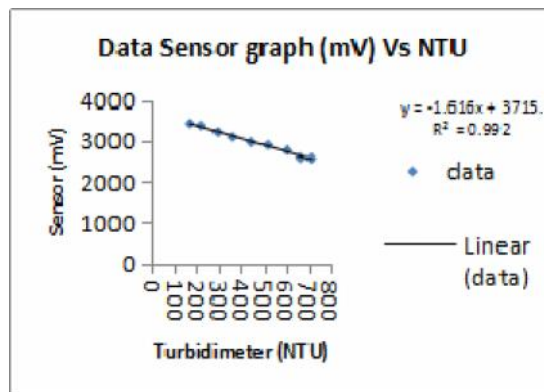

Figure 3.3 Graph linearity of the relationship between the results Turbidimeter (NTU) with the results of sensor readings (mV)

4.3. Measurement Result

After Satun converted into NTU, remeasurement do untu determine the level of accuracy of the sensor determines the values of the relative error of the measurement results. In terms of percent errors, accuracy defined by equation (4.2). The results obtained after the conversion are as follows:

Table 3.2 Data after conversion unit into NTU

Concentration solution (%)	Turbidimeter (NTU)	Sensor (NTU)	% Error
7.5	169	210.86	24.77
10	221	259.81	17.56
12.5	293	333.24	13.73
15	359	409.73	14.13
17.5	447	483.16	8.09
20	517	550.48	6.48
22.5	605	608.61	0.60
25	668	669.8	0.27
27.5	711	718.75	1.09
Average			9.35

From these data it can be seen that the tool design has an average relative error of 9:35%

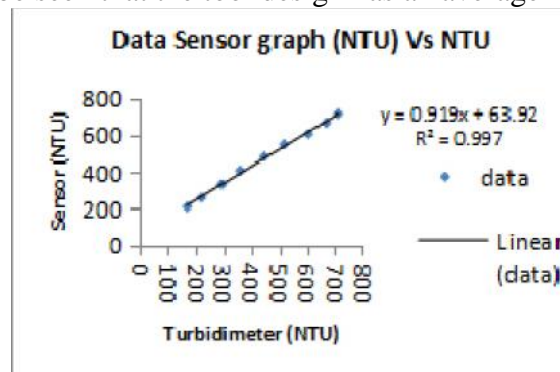

Figure 3.4 Graph linearity of the relationship between the results Turbidimeter (NTU) with the results of sensor readings (NTU)

4.4. SMS System Testing Results

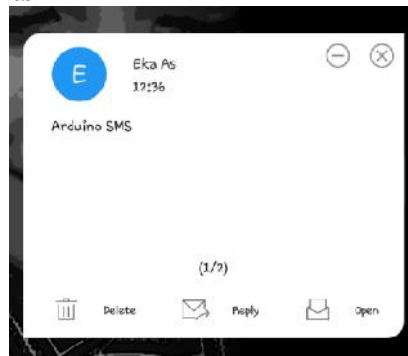

Figure 3.5 The test result GSM Shield

From the testing that has been done can be seen that the tool's ability to send SMS is the same as the range of GSM cards are used. SMS communication can reach a larger area because the GSM network has been spread in Indonesia, even in remote areas

Overall System Testing Results



Figure 3.6 The form of SMS received by the user

The process of data collection is done at five points in the watershed Ancar, Mataram. Data collection was performed for 20 minutes at each point with 1 minute delay. Here is the average value of the measurement results of the turbidity level at each point.

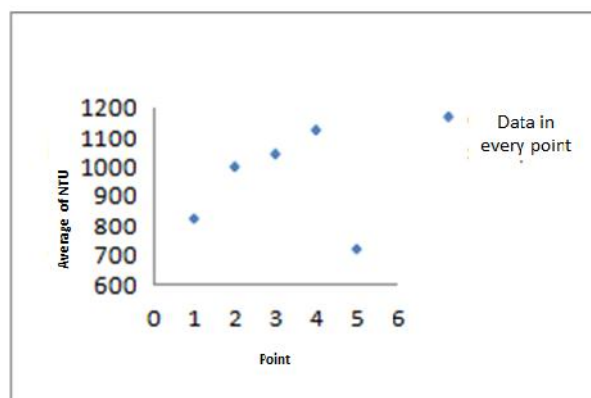

Figure 3.7 Graph of the average measurement results in every point

In theory, if there are no external factors, a river flows downstream or estuary would be more turbid than the upstream area and the center. From the data obtained in this study,

data from point one to point four are in accordance with the theory. However, the data point to a five decreased. This is because the turbidity sensor is very sensitive to light it receives. The intensity of light in the estuary downstream or greater than the upper and middle areas. As a result, the intensity of light received by the sensor is larger than the barrier material or dissolved materials, so that the sensor assumes that the water is clear.

5. Conclusion

The system uses turbidity level measuring instruments Turbidity Sensor-based SMS gateway has been successfully created and is composed of hardware and software devices. The hardware device consists of arduino uno, GSM shield, RTC, GSM card and Turbidity Sensor. Device Software consists of software arduino IDE. The system uses turbidity level measuring instruments Turbidity Sensor-based SMS gateway has been able megukur turbidity levels with an average relative error of 9.35% and is capable of sending SMS as informassi system to the user. Results obtained at each point (1-5) is 822.9; 998.2; 1040.3; 1123.5; and 718.4 in units of NTU

References

- [1] Arduino Inc. 2009. *Arduino Mega 2560* (<http://www.arduino.cc/en/Main/ArduinoBoardMega2560>) diakses pada 2 April 2016.
- [2] Bariguna, Dipo. 2008. *Studi Tingkat Kekeuhan Air Menggunakan Citra Radar Airsar*. Bogor : ITB.
- [3] Constanzo, A. (2013, Oktober). An Arduino Based System Provided with GPS/GPRSShield for Real Time Monitoring of Traffic Flows. In *Application of Information and Communication*. (AICT), 2013 7th International Conference on (pp. 1-5). IEE.
- [4] Hendrizon, Yefri Dan Wildan. 2012. *Rancang Bangunalat Ukur Tingkat Kekeuhan Zat Cair Berbasis Mikrokontroler AT89S51 Menggunakan Sensor Fototransistor Dan Penampil LCD*. Padang : Universitas Andalas.
- [5] <http://ge-mcs.com>. 2013. TSD-10 Turbidity Sensor. Diakses pada 3 maret 2016
- [6] <http://indo-ware.com/produk-3080-sensor-kekeuhan-air.html>. Diakses Pada 03 Maret 2016.
- [7] https://arduino-info.wikispaces.com/DS1307_RealTime_Clock_Brick. Di akses pada tanggal 11 Maret 2016.
- [8] International Standards Organization. 1999. *Water Quality – Determination Of Turbidity*. ISO 7027. Geneva : Switzerland.
- [9] Itead Studio .2014. *IComSat v1.1 - SIM900 GSM/GPRS shield Overview*.
- [10] Nuzula, Nike ika, dan Endarko. 2013. *Perancangan Dan Pembuatan Alat Ukur Kekeuhan Air Berbasis Mikrokontroler ATmega8535*. Surabaya: ITS.
- [11] Peraturan Menteri Kesehatan RI NO.416/MENKES/PER/IX/1990 tanggal 3 september 1990.
- [12] Pitojo dan Eling. 2003. *Deteksi Pencemar Air Minum*. Semarang : CV Aneka Ilmu.
- [13] Sutrisno. 1987. *Elektronika, Teori dan Penerapannya*. Bandung:ITB.
- [14] Thangarajah, A., Wongkaew, B., & Ekpanyapong, M. (2014). *Implementation of Auto Monitoring and Short-Message-Service System via GSM Modem*. IJCER, 3(2), 63-68.
- [15] Uldin, Riza dan Masroah. 2006. *Pemanfaatan Rangkaian Pengukur Intensitas Cahaya Untuk Rancang Bangun Alat Pengukur Tingkat Kekeuhan Air*. Semarang : Universitas Negri Semarang.
- [16] Wahyudi. 2012. *Elektronika Dasar 1*. Mataram : FKIP Press.

The Identification of Agroforestry System Plants As Raw Ingredients/Materials for Herbal Soap in Sesaot Forest

Indriyatno^{1,*}, Wiharyani Werdiningsih², I Gde Mertha³

¹Department of Forestry, Mataram University

²Department of Food Science and Technology, Mataram University

³Department of Education of Biology, Mataram University

*indrilamuk@yahoo.com

Abstract

“Back to nature” lifestyle is start to develop in the middle to high class society. The awareness of the use of herbal ingredients is increasing, considering the many risks of the use of chemical ingredients. Sesaot forest area is grown and planted by agroforestry people. The methods that have been used are exploration and description. The research of the plant's identification as raw materials for herbal soap in Sesaot Forest Area, West Lombok, has been done in June-July 2016. The objective of this research is to determine the species of plants as herbal soap's material that grow in the Sesaot Forest Area. The dominant vegetations that can be used as raw material for herbal soap are coconut (*Cocos nucifera* L.), candlenut (*Aleurites mulocana* (L.) Willd.), avocado (*Persea americana* Mill.), coffee (*Coffea canephora* Pierre ex A. Froehner), cacao (*Theobroma cacao* L.), piper (*Piper betle* L.), saffron (*Curcuma longa* L.) and yellow campaka (*Magnolia champaca* (L.) Baill. ex Pierre).

Keywords: *identification, herbal soap's raw ingredients, Sesaot Forest Area*

1. Introduction

Indonesia has a high biodiversity plants, many of them are used for cosmetics, medicines and soap materials. People prefer the herbal soap because of the bioactive compounds contained in it are relatively suited better to the skin. The soap is mixed with active ingredients that can be directly extracted by distillation process to get the essential oil.

Nowadays, the resource of soap's raw material are from forests, either from natural forest, community forests, or state forests that managed by communities (HKm). Forest management system, both in the community forest or KPH are using agroforestry systems.

The implementation of HKm program prioritized in the less productive areas, have a high accessibility, and community dependence to the forest is relatively high. Comprehensive development in West Nusa Tenggara (NTB) province until 2000 reached 35.000 ha which spread in some regencies include Sumbawa, Dompu, Bima, East Lombok, Central Lombok and West Lombok (Masnun, 2009).

The Community forests in West Lombok Regency who had a license of Alternative Community Forest (IPHKm), covers 185 ha area which spread over three villages namely, Sesaot village, Lembah Sempage village and Sedau village located in Narmada District. Sesaot protected forest is one of the forests which managed by agroforestry system community with community-based forest management schemes, in order to increase people's income and environment preservation since 1995 (Mansy, 2009).

Community forests which located in Sesaot are located outside of the State forests area. The structure and composition are similar to HKm forest using agroforestry system with combination of agricultural crops and trees. The community forests are generally located around the yard, so there are also lot of plants bio diversity, mainly used as a house decoration, and flowers as the ingredients of essential oil.

Sesaot forest area is a forest protected area that gives the consequences to not cutting the trees in HKm areas and to minimize the over logging in community forest area, considering that the area is a conservation zone in Jangkok head watershed. To increase incomes of the people in that area is to utilize the non-timber forest product. Potential as HHBK has been done but the specific benefits not been done, that's why they identify the non-timber forest plants that have potentials as raw materials for soap. The purpose of this research is to determine the types or species of the plants that grows in HKm Sesaot area and community forest that can be used as raw materials for herbal soap also to know the dominant species that cultivated by the community.

2. Materials and Methods

This research was conducted in June-July 2016. The research located in Sesaot forest area i.e. Buwun Sejati, Sesaot, Pakuan, Lembah Sempage dan Sedau Village which is in Jangkok head watershed, district of Narmada, West Lombok Regency. The production of herbarium and specimen identification have been done in Laboratory of Silviculture and Technology of Forest Products, Department of Forestry, Mataram University.

The tools used in the research were sasak herbarium, stationery, camera, books collection, pruning scissor, old newspapers, isolation, label paper, ivory paper and oven. While the materials used are spiritus (rubbing alcohol), herbarium specimen.

The type of this research is description which tend to exploration/survey. The data collection methods using survey and interview the people to get types of plants that grows in Sesaot Forest Area. From the survey result, identification has been done to know the scientific name of the plants, then from it species matched with the literature to know the plants that can be used as raw materials for the soap making. Each type of the specimens will be taken which consist of the vegetative parts (leaves and twigs) also the generative parts (flowers and fruits) if any.

3. Result And Discussion

From the result of the identification the plants that existed in Sesaot HKm are *Pterospermum javanicum*, *Theobroma cacao*, *Erythrina* sp., *Durio zibethinus*, *Coffea canephora*, *Swietenia macrophylla*, *Paraserianthes falcataria*, *Nephelium lappaceum*, *Syzygium polyanthum*, *Vanilla planifolia*, *Musa x paradisiaca*, *Persea americana*, *Ceiba pentandra*, *Aleurites moluccana* and *Piper betle*.

While there are the same plants that founded in community forest as HKm, namely coconut (*Cocos nucifera*), ylang (*Cananga odorata*), white campaka (*Magnolia alba*), yellow campaka (*Magnolia champaca*), jasmine (*Jasminum sambac*), rose (*Rosa hybrida*), pandanus (*Pandanus amaryllifolius*), clove (*Syzygium aromaticum*), tamarind (*Arenga pinnata*), agarwood (*Gyrinops verstepgii*), frangipani (*Plumiera rubra*), and white frangipani (*Plumiera alba*).

The type of plants that found in Sesaot Forest Area as soap's raw ingredients are *Theobroma cacao*, *Durio zibethinus*, *Coffea canephora*, *Nephelium lappaceum*, *Syzygium*

polyanthum, *Vanilla planifolia*, *Musa x paradisiaca*, *Persea americana*, *Ceiba pentandra*, *Aleurites moluccana*, and *Piper betle*. While the plants that located in community forest as raw ingredients of the soap are coconut (*Cocos nucifera*), ylang (*Canaga odorata*), white campaka (*Magnolia alba*), yellow campaka (*Magnolia champaca*), jasmine (*Jasminum sambac*), rose (*Rosa hybrida*), pandanus (*Pandanus amaryllifolius*), clove (*Syzygium aromaticum*), palm sugar (*Arenga pinnata*), and agarwood (*Gyrinops verstiegii*).

The dominant species or the plants that become source of income now in agroforestry system in HKm Sesaot is durian, rambutan, avocado, coffee, cocoa, piper betel, and banana. According to the interview from the community, this species of plants is the species which have a high economic value if it sold in traditional market. From the interview to the HKm Area community, they can earn about 9.000.000 – 13.000.000 Rupiahs per ha. That product usually sold in raw form. While the dominant species in community forest except that type is coconut. while the other species is just have potential to become essential oil as ylang (*Canaga odorata*), yellow campaka (*Magnolia champaca*), white campaka (*Magnolia alba*), jasmine (*Jasminium sambac*), rose (*Rosa hybrida*), pandanus (*Pandanus amaryllifolius*) only sold in limited amount in traditional market in Keru Village, district of Narmada, West Lombok Regency. They sell it in form of flowers and leaves as aoffers to worship by the Hindus.

Unlike the piper betel, it has more economic value because of the high market demand to consume or chewing the piper betel by some of the people of Lombok. Production per hA can reach 10-50 kg with the price of 50.000 Rupiah/kg. Piper betel is very potential become raw ingredients of the soap, this is because the piper betel has a function as a natural antiseptic. So when it used as a soap ingredients, many of piper betel soap favored by the local and international tourist.

4. Conclusion

From the result of the research and discussion, it can be concluded as:

There are nine types of potential plants that can be used as raw ingredients/materials which are coconut (*Cocos nucifera*), Candlenut (*Alurites mulocana*), avocado (*Persea americana*), coffee (*Coffea canephora*), cocoa (*Theobroma cacao*), piper (*Piper betle*), curcuma (*Curcuma longa*), yellow campaka (*Magnolia champaca*), white campaka (*Magnolia alba*), frangipani (*Plumiera rubra*), and white frangipani (*Plumiera alba*).

Reference

- [1] Backer, C.A. and R.C. Bakhuizen van Den Brink Jr., 1963. *Flora of Java* Vol I. N.V.P. Noordhoff. Groningen.
- [2] Backer, C.A. and R.C. Bakhuizen van Den Brink Jr., 1965. *Flora of Java* Vol II. N.V.P. Noordhoff. Groningen.
- [3] Backer, C.A. and R.C. Bakhuizen van Den Brink Jr., 1968. *Flora of Java* Vol III. N.V.P. Noordhoff. Groningen.
- [4] Mansy, 2013. 185 Ha Hutan Sesaot NTB Untuk HkM. <http://www.antaranews.com/berita/163736/185-hektare-hutan-sesaot-ntb-untuk-hkm>. Accessed on September 2016.
- [5] Masnun, 2009. NTB Targetkan 35.000 ha Hutan Kemasyarakatan. <http://www.antaranb.com/berita/24766/ntb-targetkan-35000-ha-hutan-kemasyarakatan>. Accessed on September 2016.

Growth and Yield of Onion (*Allium Cepa* Var. *Ascalonicum*) as CA Result of Addition of Biocompost and Bioactivity Fermented with *Trichoderma* spp.

I Made Sudantha^{1,*}, Suwardji¹

¹Faculty of Agriculture University of Mataram

E-Mail: imade_sudantha@yahoo.co.id

Abstract

The aim of this research was to look at the effect of biocompost and bioactivator fermented with trichoderma spp and their interaction on growth and yield of onion. A field experiment was conducted in Inceptisol at Seteluk Village, sub district of Batulayar and District of West Lombok. The treatments were split plot design which was consist of two main factors (1) with biocompost 20 t/ha and (2) without biocompost. The sub main plot was bioactivator consist of 5 levels mainly (a) without bioactivator, (b) 5 g/plant, (c) 10 g/plant, (d) 15 g/plant and (e) 20 g/plant. The result of this study showed that there was a significant higher on growth and yield of onion after addition of biocompost compared with without addition of biocompost. There was no interaction between biocompost and bioactivator. Furthermore, the effect of addition of biocompost at level of 10 g/plat resulted to the highest growth and yield of onion compared with other levels addition of biocompost.

Keywords: *biocompos*, *bioactivator*, *Trichoderma* spp., *onion*, *allium cepa* L.

1. Introduction

Onion(*Allium cepa* var. *ascalonicum*.) is becoming very populer horticultural crops in Indonesia due to its high economical value as well as its multi used of onion for food flavour and medical or pharmaceutical materials (Anonim, 2014). West Nusa Tenggara Province is one of the centra onion production in Indonesia after East Java, Central Java and West Java Province. However, the onion production in Indonesia is still low due to some constrains in the crop production systems.

Some factors that are responsible low production of onion in the West Nusa Tenggara Province are the use of low quality of seed and conventional farming practice by using high levels of inorganic fertilzer such as NPK Fertilizer (Sudhanta, 2015).

The use of bioactivator containing saprofit fungsi of *T. harzianumi* and isolate of SAPRO-07 and fungsi endofit of *T. koningii* isolate has been reported increased growth and yield of vanilia (Sudantha 2010a), increased growth and yield of corn (Sudantha and Suwardji,2013), increased growth and yield of soy bean (Sudantha and Suwardji, 2014), increase growth and yield of onion in the pot trial (Sudantha 2015).

In this paper we reported result of field trial the effect of biocompost and bioactivator fermented with *Trichoderma* spp on growth and yield of onion in the field trial.

2. Materials and Methods

Field trial was conducted at Seteluk Village, sub district of Batulayar and District of West Lombok from June to August 2016. Split plot experimental design was used to set up this field experiment which was consists of main treatment biocompost (1) with biocompost 20 t/ha and (2) without biocompost. Sub treatments were application of bioactivator which consist of five levels mainly (a) without bioactivator (b) 5 g/plant of bioactivator (c) 10 g/plant of bioactivator (d) 15 g/plant of bioactivator and (e) 20 g/plant of bioactivator. The treatment was repeated three times, resulted in $2 \times 5 \times 3 = 30$ experimental plots.

Biocompost of coconut shell was crushed and sieved with a 1.0 mm, then moistened with

T. koningii (Endo-04) and *T. harzianum* (isolates Sapro-07) suspense, where been grown on PDA. Solution was used water solvents which added 2.5 g granular sugar. The density of spore in suspension were 10⁷ spores/ml. This solution is commonly known as Biotricon. Biocompost compounds had been added Biotricon were at 20-24% in moisture content. Biocompost was placed in container and sealed properly in anerobic condition and incubated in the room temperature. The incunbation period was used 28 days.

Fungi *Trichoderma* spp. was used in this study and had been cultured *T. koningii* isolates Endo-04 and *T. harzianum* isolates Sapro-07, were collected by Sudantha stored in Laboratory of Plant Protection, Agriculture Faculty, Universitas Mataram. Growing up used PDA (Potato Dextrosa Agar) with incubation period were 14 days.

The Bioactivator was made of leaves coffee had been dried at 60⁰C for 14 days, after that it was crushed with a coffee mill and then sieved. The result of sieve powder was mixed with clay at 1:3 (v/v) in ratio then sterilized with *autocave*. The mixing matters were inoculated with fungi conidial biomass suspense *T. koningii* ENDO-2 and *T. harzianum* SAPRO

Plots size were 5x2 m² cropping spaces were 25 cm x 20 cm, so there were 200 plant per plot. Onion seed seeds used was cultivar of Philip. Planting hole at depth of 2.5 cm. Combination of biocompost and bioactivator were applied on treatment basis as discussed above. During the growing season, water was applied based on furrow irrigation based on its onion requirement and weeding also applied at 20, 40, and 60 days after planting. Harvesting was done after 103 days after planting.

Data were analysed using analysis of variance (2009), any significant different among means were then tested using Ducan’s Multiple Test at probability level 95%.

3. Results and Discussion

3.1. Characteristis of Biocompost and Soil’s Chemical Properties after Fermentation and Addition of Biocompost Fermented with *Trichoderma* spp.

Fermentation of biocompost using trichoderma spp affected the biocompost and soil properties. Chemical tests showed that there were decreased of biocompost pH and C/N ratio, but enhanced %-N. One of the most important of the benefit of fermentation was reducing C/N ratio. This has a significant implication on accelerating degradation of biocompost and become nutrient that may available for plant growth. Similarly fermentation biocompost also increased cation exchange capacity (CEC) (*Table 1.*).

Table 1. Chemical Change of Biocompost and Soi Properties after Fermentation and Application of Fermented Biocompost

Parameters	BC Properties			Soil Properties ^a					
	BC	FBC	Anova ^b	Basic	Soil (control)		Soil + BCT (20 tons/ha)		Anova ^b
				-1 st Day	30 th Days	60 th days	30 th Days	60 th Days	
pH (H ₂ O)	7,8	7,2	*	6,5	6,4	6,5	6,4	6,2	ns
CEC (cmol _c kg ⁻¹)	23,81	26,28	*	12,25 a	11,66 a	12,41 ab	14,53 c	14,24 bc	*
C (%)	62,00	60,00	*	2,80	2,65	3,10	3,15	3,00	ns
N (%)	0,37	0,82	**	0,18 a	0,23 ab	0,34 d	0,25 bc	0,31 cd	*
C/N Ratio	167	73	**						
Soil Respiration (μmol CO ₂ kg ⁻¹ ha ⁻¹)	-	-		9,21 a	12,42 b	11,83 b	12,05 b	13,62 b	*

^aMeans followed by the same letter at each row are not significantly different (P<0.05)

Using this fermented biocompost (FBC) were 20 tons ha⁻¹, results of statistical

analaysys on chemical tests showed that the fermentation of BC has no significance different effect on Biocompost pH and soil organic carbon (SOC), but signifcantly increased cation exchange capacity (CEC), %-N, C/N ratio and soil respiration.

Increasing CEC of soil were higher in soil applied FBC both on 30 and 60 days after application measured than without FBC application at the same period (30th and 60th days). By comparing before (1st day = 12.25 cmol_c kg⁻¹) and after fermentation and application both without FBC (30th cmol_c days = 11.66 cmol_c kg⁻¹ and 60th days = 12.61 cmol_c kg⁻¹) and with FBC application (Soil+FBC in 30th days = 14.53 cmol_c 1st kg⁻¹ and 60th days = 14.24 cmol_c kg⁻¹) also showed improvement

3.2. Effect of Biocompost and Bioactivator on The Growth of Onion

Results of analysis of variance showed that application of both fermented biocompost and level of bioactivator were both significantly increased on plant heigh at 14,21,28 and 35 days after planting (DAP). Furthermore analysis using Least Square Different (LSD) at probability 95% can be seen at Tabel 1 and 2.

Tabel 1. The influence of biocompost on the hight of plant

Treatments	Mean the heigh of Onion Plant (cm)			
	14 DAP	21 DAP	28 DAP	35 DAP
With Biocompost	23,03 a ¹⁾	27,34 a ¹⁾	30,31 a ¹⁾	32,73 a ¹⁾
Without Biocompost	21,78 b	24,66 b	26,23 b	28,81 b
LSD P< 5%	1,10	2,98	3,86	3,12

1) Means followed with the same letter in the same colum are not significantly different.

2) DAP = Day after planting

Table 1 showed that the addition of biocompost fermented with *Trichoderma* spp significantly increased plant heigh at 14 DAP, 21 DAP, 28 DAP and 35 DAP compared with the height of plant without addition of biocompost. Sudantha and Suwardji (2016) advocated that addition of fermented biocompost with *Trichoderma* spp was able to accelerate the vegetative growth of onion. Similarly Salisbury dan Ross (1995) found that some fungi that life in the soil can produce etylene that are able to stimulate the growth of plant and also able to protect the plant from root rot desease. Moreover ethelence produced by the fungi is also able to speed up the flowering time. Sudantha (2010a) also found that fungi of endofit *Trichoderma* spp. was able to colonize in the plant tissues. As a result of ethylene produced in the plant tissues, the plant was cappable of accelerating the growth of plant tissue. Moreover, Trautman dan Olinceiw (1996) reported that *Trichoderma harzianum* was able to produce cellulose enzyme that are capable of decomposing organic matter containing lignin and cellulose to the simple compounds which are dissolve in soil solution and becoming available for plant growth and development.

Table 2. Influence of Bioactivator Level on Plant Heigh of Onion

Treatment of Bioactivator	Mean of Onion Plant Heigh(cm)			
	14 DAP	21 DAP	28 DAP	35 DAP
Without bioactivator	21,30 a ¹⁾	24,10 a ¹⁾	26,08 a ¹⁾	27,10 a ¹⁾
5 g/plant	22,51 b	25,75 b	27,25 b	31,22 b
10 g/plant	22,75 bc	26,74 bc	28,43 bc	32,67 bc
15 g/plant	23,74 c	27,28 c	28,67 c	32,74 c
20 g/plant	23,71 c	27,37 c	28,70 c	32,73 c
LSD at P < 5%	1,27	1,51	1,03	1,35

1) Values followed by the same symbon in the same colum are not sigificantly different at P<5%

2) DAP= Day after planting

Table 2 showed that the level of bioactivator significantly influenced plant heigh of

onion at 14 DAP, 21 DAP, 28 DAP and 35 DAP. All treatments were significantly increased plant height. Comparing the levels of treatments, doses of 10 g/plant of bioactivator considered to be the level that is significantly increase the plant height and economically viable. This results suggested that bioactivator containing fungi of *T. koningii* isolat Endo-02 dan *T. harzianum* isolat Sapro-07 can stimulate plant height of onion.

Our data also suggested that bioactivator containing fungi of *T. koningii* isolat Endo-02 dan *T. Harzianum* isolat Sapro-07 were more prominent in increasing the height of plant of onion compared with biocompost suggesting that the use of bioactivator may economically viable and practically more easy for farmers. Similar results has been reported by Sudantha et al (2016) suggested that 10g/plant of bioactivator can significantly increased the plant height of onion and economically viable conducted in other research for other soil types. As previously reported that Sudantha (2010b) also found that fungi endofit *T. koningii* isolat ENDO-02 in the plant tissue produced etylene which able to stimulate vegetative growth of plant.

Further statistical test using LSD at P <5% for the influence of biocompost conducted independently on other plant parameters suggested that bioactivator significantly increased number of tillering, fresh weight of plant and number of plant bulb of onion (Table 3).

Table 3. Influence of biocompost on number of tillering, fresh weight of plant and fresh bulb weight of onion

Treatments	Number of tillering (bulb/rumpun)	Fresh weight of plant (g/rumpun)	Fresh bulb of onion (g/rumpun)
With biocompost	6,78 a ¹⁾	39,11 a ¹⁾	33,57 a ¹⁾
Without biocompost	5,13 b	27,38 b	22,42 b
LSD 5%	1,63	1,02	1,77

1) Values followed by the same symbol in the same column are not significantly different at P<5%

Table 3 suggested that addition of biocompost significantly increased number of tillering and fresh weight plant and fresh weight of bulb. This results similar to the results of Sudantha et al (2016) in the glass house experiment that addition of biocompost significantly increase number of tillering, plant fresh weight and fresh weight of bulb of onion. Furthermore Sudantha dan Suwardji (2013) also found application of biocompost fermented with fungi of endofit and saprofit *Trichoderma* spp increased plant height and development of onion and yield of onion.

Table 4. Influence of bioactivator on number of tillering, fresh weight of plant and fresh bulb of onion

Treatments	Number of tillering (bulb)	Fresh weight of plant (g)	Fresh weight of bulb (g)
Without bioactivator	4,91 a ¹⁾	29,42 a ¹⁾	23,71 a ¹⁾
5 g/plant	5,36 b	32,36 b	27,11 b
10 g/plant	5,62 bc	35,10 bc	28,06 bc
15 g/plant	5,87 c	35,56 c	30,86 c
20 g/plant	5,93 c	36,48 c	31,02 c
LSD P<0,5%	0,50	2,75	2,95

1) Values followed by the same symbol in the same column are not significantly different at P<5%

Table 4 showed that application of bioactivator containing fungi of *T. Koningii* isolate Endo-02 dan *T. harzianum* isolat Sapro-07 significantly increased number of tillering, fresh weight plant and fresh weight of bulb in comparison with without application of bioactivator. The data also suggested that application of bioactivator 10g/plant also significantly increased number of tillering and fresh weight plant and fresh weight of bulb.

The fact indicated that application of bioactivator capable of increasing yield of onion due to the dominant role of fungi of *T. harzianum* isolat Sapro-07. Similar reason that have been suggested in the above paragraph are apply for increasing of yield of onion as a result of application of bioactivator.

4. Conclusion

Result of this study suggested that the addition of biocompost to the soil resulted in higher growth and yield of onion compared with without addition of biocompost. In addition, the growth and yield of onion become much more higher with the additon of bioactivator at level up to 10 t/ha.

Further research should be directed to look at the method of application of biocompost and bioactivator to achieve potential yield of onion used in this study.

Acknowledgement

Financial support was provided by Ministry of Research, Technology and Higher Degree Education Republic of Indonesia for providing research funding, financial Year of 2016.

References

- [1] Anonim, 2014. Ditjen Tanaman Pangan, Hortikultura, Peternakan, Badan Pusat Statistik. <http://www.ekon.go.id/media/filemanager/2014/11/19/k/e/kementan.pdf>
- [2] Arianci, R. 2014. Pengaruh Campuran Kompos Tandan Kosong Kelapa Sawit, Abu Boiler dan Trichoderma terhadap Pertanaman Kedelai pada Sela Tegakan Kelapa Sawit yang Telah Menghasilkan di Lahan Gambut. *Jurnal Teknobiologi*, 5(1), 21-29
- [3] Cook, R. J. and K. F. Baker. 1983. *The Nature and Practice of Biological Control of Plant Pathogens. The American Phytopathol. Society*, St. Paul MN. 539 p.
- [4] Latifah, A. Kustantinah, Loekas Soesanto. 2011. Pemanfaatan Beberapa Isolat *Trichoderma harzianum* sebagai Agenia Pengendali Hayati Penyakit Layu Fusarium pada Bawang Merah. *Eugenia Vol.17 No 2*. Universitas Jenderal Soedirman.
- [5] Salisbury, F.B., and C. W. Ross, 1995. Fisiologi Tumbuhan Jilid 3. Perkembangan Tumbuhan dan Fisiologi Tumbuhan (Terjemahan D. R. Lukman dan Sumaryono). Penerbit ITB, Bandung.
- [6] Sudantha, I. M. 2009. Aplikasi Jamur *Trichoderma* spp (Isolat ENDO-02 dan 04 serta SAPRO-07 dan 09) Sebagai Biofungisida, Dekomposer, dan Bioaktivator Pertumbuhan dan Pembungaan Tanaman Vanili dan Pengembangannya pada Tanaman Hortikultura dan Pangan Lainnya di NTB. Laporan Penelitian Hibah Kompetensi DP2M DIKTI, Mataram.
- [7] Sudantha, I. M. 2010a. Buku Teknologi Tepat Guna: Penerapan Biofungisida dan Biokompos pada Pertanian Organik. Fakultas Pertanian Universitas Mataram, Mataram.
- [8] Sudantha, I. M. 2010b. Aplikasi Jamur *Trichoderma* spp (Isolat ENDO-02 dan 04 serta SAPRO-07 dan 09) Sebagai Biofungisida, Dekomposer, dan Bioaktivator Pertumbuhan dan Pembungaan Tanaman Vanili dan Pengembangannya pada Tanaman Hortikultura dan Pangan Lainnya di NTB. Laporan Penelitian Hibah Kompetensi DP2M DIKTI, Mataram.
- [9] Sudantha, I. M. dan Suwardji. 2013. Pemanfaatan Biokompos, Bioaktivator dan Biochar Untuk Meningkatkan Hasil Jagung dan Brankasan Segar pada Lahan Kering Pasiran dengan Sistem *Irigasi Sprinkler Big Gun*. Laporan Penelitian Strategis Nasional, Mataram.
- [10] Sudantha, I. M. Dan Suwardji, 2014. Pemanfaatan Bioaktivator dan Biokompos (Mengandung Jamur *Trichoderma* spp. dan Mikoriza) Untuk Meningkatkan Kesehatan, Pertumbuhan dan Hasil Tanaman Kedelai di Lahan Kering. Laporan Hibah Tim Pascasarjana DP2M Dikti, Mataram.
- [11] Sudantha, I. M. 2015. Pemanfaatan Bioaktivator dan Biokompos untuk Meningkatkan Kesehatan, Kuantitas dan Kualitas Hasil Bawang Merah. Laporan Penelitian Mandiri Program Magister Pengelolaan Sumberdaya Lahan Kering Program Pascasarjana Unram.
- [12] Sudantha, I. M., Suwardji, dan M. T. Fauzi. 2016. Pemanfaatan Bioaktivator dan Biokompos Hasil

- Fermentasi Jamur *Trichoderma* spp. serta Fungi Mikoriza Abuskular Untuk Meningkatkan Kesehatan, Pertumbuhan dan Hasil Bawang Merah. Laporan Penelitian Sumber Dana BLU PNBP Unram Tahun 2016.
- [13] Trautman, N. and E. Olynciw, 1996. Compost microorganism. Cornell Composting. Science and Engineering. Cornell University. 16 hal.
- [14] Triyatno, B. Y. 2005. Potensi beberapa Agensia Pengendali terhadap Penyakit Busuk Rimpang Jahe. Fakultas Pertanian Universitas Jenderal Soedirman, Purwokerto.
- [15] Windham, M., Y. Elad and R. Baker. 1986. A Mechanism of Increased Plant Growth Induced by *Trichoderma* spp. *Phytopathology* 76: 518 - 521.