

# EFFECT OF FLY ASH AS REINFORCEMENT ON MECHANICAL PROPERTIES OF ALUMINUM SCRAP BASED HYBRID COMPOSITE

*by Amir Arifin*

---

**Submission date:** 24-May-2019 03:05PM (UTC+0700)

**Submission ID:** 1135317567

**File name:** CHANICAL\_PROPERTIES\_OF\_ALUMINUM\_SCRAP\_BASED\_HYBRID\_COMPOSITE.pdf (645.07K)

**Word count:** 3846

**Character count:** 20597

10  
**EFFECT OF FLY ASH AS REINFORCEMENT  
ON MECHANICAL PROPERTIES OF ALUMINUM SCRAP  
BASED HYBRID COMPOSITE**

AMIR ARIFIN, RIMAN SIPAHUTAR, DIAH KUSUMA PRATIWI,  
IRWIN BIZZY, DWI PURBA, GUNAWAN\*

Department of Mechanical Engineering, Faculty of Engineering, Universitas Sriwijaya,  
30662 Indralaya, Sumatera Selatan, Indonesia  
\*Corresponding Author: gunawan@unsri.ac.id

**Abstract**

26  
Aluminum matrix composite (AMC) has been widely used in various industries such as Automotive, aerospace and marine. One of the constraints to fabricate AMC is the high costs involved. Fly ash is a coal combustion waste that have considerable potential as an alternative material for the manufacture of AMC. In this work, AMC was fabricated through stir casting methods, alumina and fly ash are utilized as reinforcement. Mechanical properties of the composite were analysed based on the results of impact test, tensile test and hardness test. Impact test revealed the maximum energy absorbed of the AMC is 14.224 Joule with composition 8 wt% alumina and 12 wt% fly ash. Moreover, tensile strength and hardness testing result on AMC showed the similar tendency. Mechanical properties increase linearly with increasing the addition of fly ash. The maximum value was obtained at 133.74 MPa and 65.37 BHN for tensile strength and hardness number, respectively. Microstructural results also showed that there was grain refinement to the addition of fly ash composition, which supports the mechanical properties result.

Keywords: Aluminum matrix composite, Aluminum alloy, Fly ash, Mechanical properties, Stir casting.

## 1. Introduction

Recently, with the rapid technological achievement in aerospace, medical, automotive and marine led to huge demand in the materials having superior properties [1]. The mechanical properties of material are main consideration in selection material to utilize in a structure. Improvement of mechanical properties such as hardness and strength has been a major goal in material engineering research, especially in the field of metal matrix composite. Some efforts have been made by researchers to produce superior materials with various fabrication methods, such as forming, casting and powder metallurgy [2 - 8].

Composite is combining two or more micro/macro matter having different composition that consists of a matrix as base material and reinforcement as reinforcement material [9]. Rapid technological development with extreme in operational condition tends to require a superior material. Metal matrix composite (MMC) is one of the solutions to overcome this problem. MMC consists of metal and hard materials as matrix and reinforced, respectively. A combination of two materials in the design of MMC is expected to produce the desired mechanical properties [10].

Generally MMC has some advantages properties such as higher specific strength, weight reduction, excellent wear resistance, lower coefficients of thermal expansion (CTEs) and high vibration damping [11]. Metal matrix composite in term aluminum as matrix is recognized as Aluminum Matrix Composites (AMC). AMC have been widely used for aerospace structures, automotive and marine industry [12]. Manufacturing of conventional AMC tend costly in term processes and material usage, thus restricting in terms of its usage in the structure.

Combustion process of coal in power plants to generate electricity always produced solid coal utilization by-products (CUBs) which is produced by non-combustible part of the coal. Physical and chemical characteristics of CUB is unique depend on parameter process during combustion process; moreover it has complex matter such as fly ash, bottom ash, slag and gas [13, 14]. CUBs have become interesting issue for research due to give great impact to environment especially for surrounding power plant [14, 15]. Fly ash is one component of the CUBs that always present during combustion coal process. It separated from exhaust gases of combustion process of coal, Fly ash comprising to oxide and metal oxides of silicon, aluminum, iron, and calcium in natural ceramic formed [16, 17].

Some efforts have been performed to find potential material as alternative reinforcement for AMC. Based on previous work that reported some author, fly ash can be strong candidate as alternative reinforcement for AMC [11, 18-20]. Kulkarni et al. [11] reported that compressive strength of aluminum 356 alloy increased with additional fly ash and alumina. Kumar et al. [10] also reported hardness and tensile strength increase linearly with increasing the weight fraction of  $Al_2O_3$ . Gikunoo et al. [18] reported that microhardness, tensile strength and impact of aluminum A353 decreased with increasing weight percentage of fly ash.

Stir casting is standard method to produce aluminum metal composite, involving of a melt matrix material followed by the introduction of reinforcement material into the melt. Stirring process is performed during mixing matrix and reinforce material to obtain homogeneous distribution of reinforcement material. Some factors should be consider to achieve the high quality of MMC such as the

uniformity of the particle distribution of reinforcing materials, porosity MMC and also the bond between the substance [21].

In this work, stir casting was performed to fabricate aluminum matrix composite (AMC) with fly ash and  $AlN_3$  as hybrid reinforcement. Some of earlier investigations showed the mechanical properties of aluminum composite reinforced with single particulate material such as SiC,  $Al_2O_3$ , and graphite. Moreover, development of hybrid composite that compose two or more reinforced material including  $Al_2O_3$  and fly ash is very interesting research area. Fly ash is a hazardous material that available abundantly and cheap (approximately 1/5 of SiC particles) and its utilization can further reduce the negative impact. The objective of this work is to investigate the effects of fly ash on mechanical properties of Al-3.38Zn alloy. The mechanical properties were assessed by impact, tensile strengths and hardness testing.

## 2. Experimental Procedure

The fly ash is supplied by power plants located in the area of Tanjung Enim in South Sumatera Province, Indonesia. It has 40 mesh size with irregular shape.  $Al_2O_3$  has size 75  $\mu m$  with irregular shape. The chemical composition of both fly ash and alumina can be seen in Table 1.

**Table 1. Typical chemical compositional of fly ash.**

Materials	Chemical compositions (%)							
	SiO <sub>2</sub>	Al <sub>2</sub> O <sub>3</sub>	Fe <sub>2</sub> O <sub>3</sub>	TiO <sub>2</sub>	CaO	MgO	K <sub>2</sub> O	others
Fly Ash	57.95	28.15	4.75	0.93	3.74	1.73	0.62	2.13
Alumina	0.018	99.70	0.02	0.006	-	-	-	0.26

Metal matrix composites, processed by stirring casting route were conducted in this work. In the present experimental investigation Al-3.38%Zn alloys are used as a matrix material, meanwhile  $Al_2O_3$  (8 wt%) and Fly ash (4, 8 and 12 wt%) used as hybrid reinforce. The chemical composition of Al-3.38%Zn alloys for this work is given in Table 2.

**Table 2 Typical chemical compositional limits of alloying elements in Al-3.38Zn alloy**

Element*	Zn	Cu	Fe	Pb	Ni	Ti	Sn
wt%	3.38	1.83	1.098	0.161	0.094	0.071	0.036

\*Balance = aluminum

Al-3.38%Zn alloys was melted in a crucible at 700 °C which is more than 50 °C above liquidus temperature of the matrix alloy. Before being added to the molten aluminum alloy, Fly ash is heated at 400 °C for 1 hour to remove the gases and water vapour contained in fly ash [22, 23]. The molten aluminum alloy was stirred until generate vortex, during molten aluminum alloy was stirred preheat fly ash was added slowly. Irrigating the aluminum solution is intended to facilitate for uniform distribution of fly ash, which has a density that is lighter than aluminum alloys [3].

Figure 1 shows the design sample for tensile, hardness and impact strength refers to the standard JIS Z 2201 and JIS Z 2202, respectively. All of mechanical properties test sample were obtained by cutting from the as cast sample. Figure 2 shows stir casting process that has been done to melt Al-3.38% Zn alloys, mixing blade is 350 rpm was generated by the electric motor with speed control equipment.

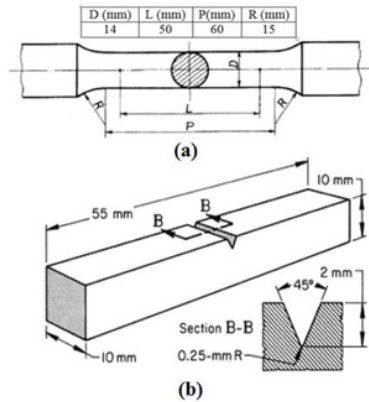

Fig. 1. Specimen test based on Japanese Industrial Standards; (a) JIS Z 2201 and (b) JIS Z 2202.

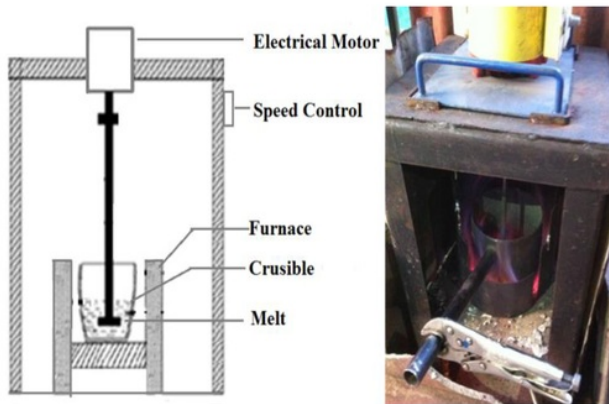

Fig. 2. Schematic of stir casting process.

### 3. Results and Discussion

Figure 3 shows the specimen for impact, tensile and hardness test that produced using stir casting methods. Mechanical Properties of Al-3.38Zn alloy hybrid composite analysis of mechanical properties carried out through tensile testing, hardness and impact testing. The toughness of material is one of important properties for engineering material. Measurement material toughness is usually

determined based on the consumption of energy that can be absorbed before the material is fracture.

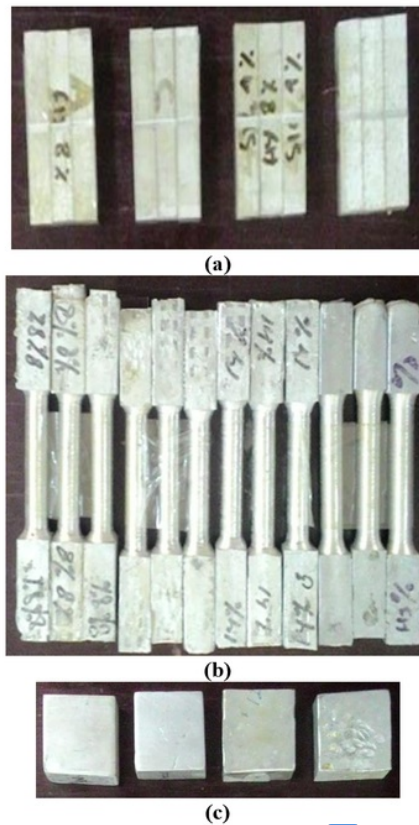

Fig. 3. Cast sample for mechanical testing. (a) impact test (b) tensile test and (c) hardness test.

Figure 4 shows the variation of Charpy impact energy with increasing fly ash content (wt%). It can be observed that the energy absorbed in fracturing the specimen is increased linearly with increasing fly ash content. It is in accordance that have been reported by Kumar et al. [10], that the addition of a weight percentage of fly ash will increase the mechanical properties of aluminum alloys.

Maximum energy absorbed (14.22 Joule) was obtained at composition of 12 wt % fly ash and 8 wt%  $Al_2O_3$  while AMC without fly ash content has minimum energy Absorbed (5.558 J).

Variation of tensile strength with weight percentage of fly ash content is shown in Fig. 5. Tensile strength of composite increase linearly with increasing of fly ash content. This is describing clearly that fly ash particulate influence tensile strength

22  
of aluminum alloy. The existence of fly ash particles in the aluminum matrix act as an obstacle for the movement of dislocations and which strengthen the aluminum composite. Based on the results of tensile test that maximum value of tensile strength was obtain at composition 12 wt% fly ash while minimum value of tensile strength without fly ash content.

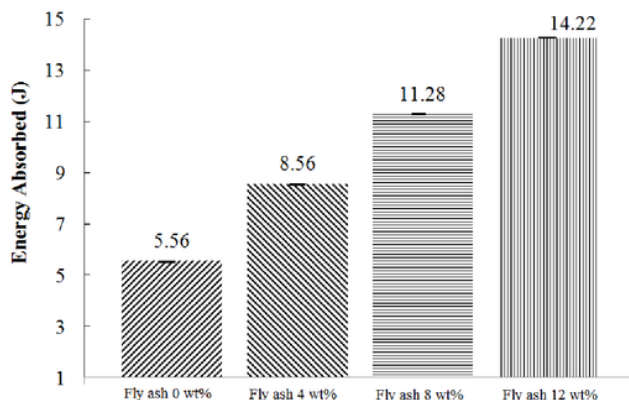
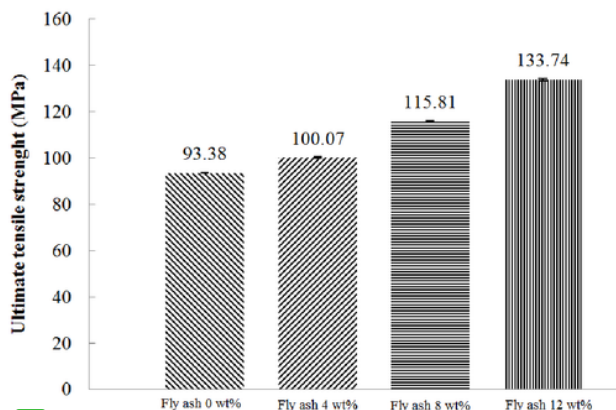
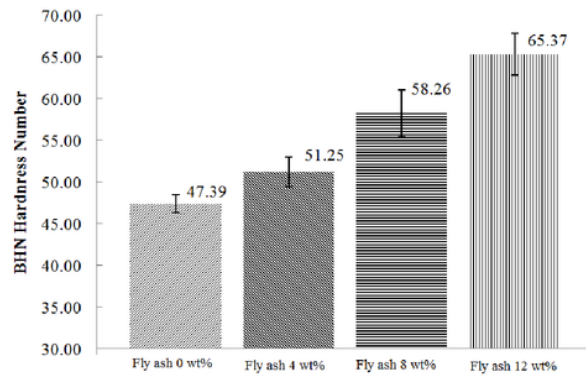

Fig. 4. Variations of Charpy energy with composition of 8 wt% Alumina and various weight percentage of fly ash content.



29  
Fig. 5. Variation of tensile strength with composition of 8 wt% Alumina and various weight percentage of fly ash content.

Ceramics generally tend to have a higher hardness value than the metal. Fly ash comprising to combination of main types of ceramics such as SiO<sub>2</sub>, Al<sub>2</sub>O<sub>3</sub>, Fe<sub>2</sub>O<sub>3</sub>, CaO, MgO and K<sub>2</sub>O proved to increase the hardness number of AMC [23, 24]. Figure 6 shows the addition of fly ash weight percentage increasing proportionally AMC hardness number.



**Fig. 6. Variations of hardness with composition of 8 wt% Alumina and various weight percentages of fly ash content.**

Figure 7 shows the elongation of Al-3.38%Zn alloys with various weight percentage of fly ash. Maximum ductility of Al-3.38%Zn alloys is obtained at 12 wt% fly ash with elongation value 8.27 %. The elongation of the composites increased with an increase in the weight fraction of the fly ash. Fraction volume and interface bonding between matrix material and reinforcement play important role to influence elongation of aluminum matrix composite [25]. Moreover, existence of reinforcement particles in Al-3.38%Zn alloy as constraints function on the plastic flow of the matrix.

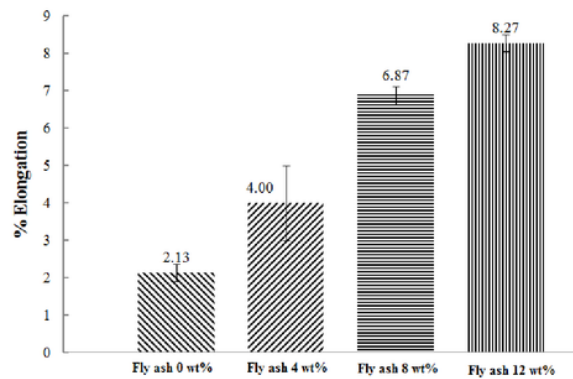

**Fig. 7. Influence of fly ash percentage on the elongation Al-3.38Zn-1.83Cu alloy hybrid composite.**

The effect of particulate ceramics as reinforcement in metal matrix composite (MMC) to the elongation is still being debated, which some researchers believe on existing of an influence to improve and *vice versa*. Table 3 shows the effect of adding ceramic as the reinforcement of the MMC, which improves elongation.



**Table 3. Comparison elongation results of the current study with other researchers.**

Matrix Composition	Reinforcement	Process	Elongation (max)	Ref.
Al-Cu-Zn-Mg	Al <sub>2</sub> O <sub>3</sub>	Stir Casting	17%	[26]
Al-11.8%, Si 1.4	Al <sub>2</sub> O <sub>3</sub>	Vertex	6%	[27]
Al-28.2%Cu, 1.94Mg	Al <sub>2</sub> O <sub>3</sub>	Vertex	3.2%	[28]
Al 1.6% Cu, 2.5% Mg, 37%Zn	SiC	Stir casting	1.56%	[29]
Al 2.7% Cu, 1.8% Mg, 4.40% Zn	SiC	Stir casting	17%	[30]
Al-3.38%Zn-1.83%Cu	Al <sub>2</sub> O <sub>3</sub> & Fly Ash	Stir casting	8.27%	Current research

In the case of aluminum matrix composite distribution of reinforcement particle in aluminum matrix have significant contribution on mechanical properties of composite. Distribution of fly ash in aluminum matrix was observed by optical microscope Olympus STM6-LM optical microscope. Figure 8 illustrates the typical microstructure of microstructure of Al-3.38%Zn alloys reinforced alumina and fly ash. Figs. 8(a) and (b) show the increasing weight percentage of fly ash affects the grain refinement of the microstructure of Al-3.38% Zn alloys. Grain refinement occurs due to the addition of fly ash, which comprising to the ceramic element with high melting. The existence of ceramic element functioning as the initial nucleus during the solidification Al-3.38% Zn alloys. According to Johkio [30] increasing weight percentages of Al<sub>2</sub>O<sub>3</sub> on the aluminum alloy increased strength and ductility vary up to 10%. In this work, the samples aluminum alloy with 8 wt% of alumina and fly ash vary from 0 to 12 wt% was added into aluminum alloy. In other word alumina portion increased by adding fly ash. The existence of Al<sub>2</sub>O<sub>3</sub> powders perform to grain refinement of aluminum casting composite during solidification process.

Grain refinement plays a critical role in affecting the mechanical properties of materials such as hardness, tensile strength and impact resistance [31]. Hardness, tensile strength and impact test previously revealed that Al-3.38% Zn alloys composite with a finer grain size has maximum value. Moreover, on Fig. 8(b) was found the uniform distribution of reinforcement elements. The present of reinforcement elements would prevent dislocation movement and thus increase mechanical properties.

Generally, it is well known that the mechanical strength (i.e., Young's modulus, yield stress, tensile strength and fracture stress) of AMC of ceramic-reinforced was higher than its pure alloys and improve with percentage ceramic materials portion. The mechanism and failure mode of aluminum matrix composites can be obtained from fractographic analysis of tensile testing. The tensile fracture surface characteristic consisting of numerous dimples as shown in Figs. 9(a) to (d). It can be observed that the dimples formation on the surface increased as increasing fly ash particles in which large dimples is observed in Fly Ash 12 wt%. The formation of dimples indicates a plastic deformation. It is suggested that an extensive plastic deformation formed the dimples associated with the reinforcing particles. This is in an accordance with the elongation and the energy absorption result. Reinforced composite materials leading to a higher energy absorption that showed increasing energy consumption for plastic deformation.

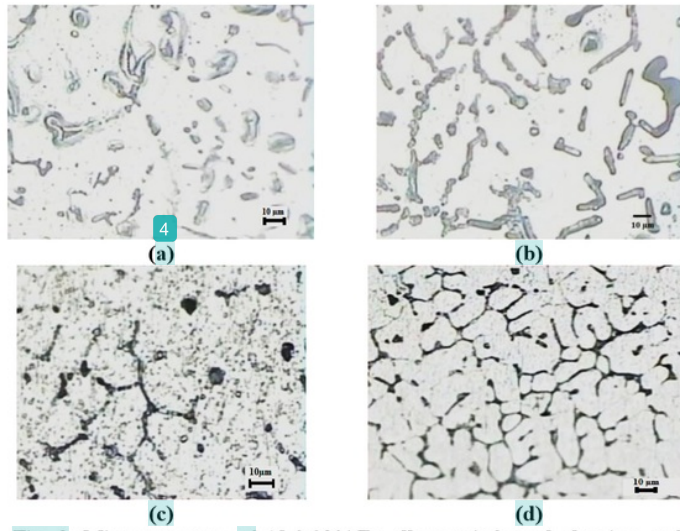

**Fig. 8.** Microstructure of Al-3.38%Zn alloys reinforced alumina and fly ash; (a) Alumina 8 wt% Fly Ash 0 wt%, (b) Alumina 8 wt% Fly Ash 4 wt% , (c) Alumina 8 wt%, Fly Ash 8wt% and (d) Alumina 8 wt%, Fly Ash 12 wt%.

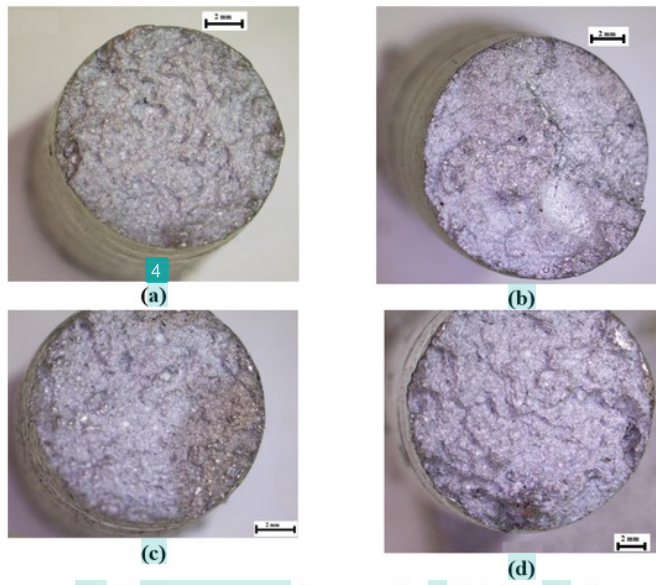

**Fig. 9.** Macrostructure fractography of Al-3.38%Zn alloys reinforced alumina and fly ash; (a) Alumina 8 wt% Fly Ash 0 wt%, (b) Alumina 8 wt% Fly Ash 4 wt% , (c) Alumina 8 wt%, Fly Ash 8wt% and (d) Alumina 8 wt%, Fly Ash 12 wt%

#### 4. Conclusions

In summary, Al-3.38%Zn alloys hybrid composite with alumina 8 wt% and various composition of fly ash (0, 4, 8 and 12 wt%) was successfully fabricated via stir casting method. In this work the addition of fly ash powder into Al-3.38%Zn alloys + 8 wt% Al<sub>2</sub>O<sub>3</sub> is able to enhance the mechanical properties of the AMC in this case the value of hardness, energy absorption and tensile strength. Results revealed that the proportional increase occurred in the addition of fly ash ranges from 0 - 12 wt% by weight. According to analysis using an optical microscope that the addition of fly ash plays a critical role on the grain refinement of Al-3.38%Zn alloys. The fracture surface on the specimen was observed many dimples with increasing weight percentage of fly ash. Dimple formation on the fracture surface indicates the tendency of ductile material properties. It is also demonstrated and accordance with elongation measurement results of specimen tensile. Overall results showed that fly ash has great potential as a reinforcement of aluminum matrix composite (AMC).

#### Acknowledgment

The authors would like to convey their great appreciation to Universitas Sriwijaya for supporting this research.

#### Nomenclatures

AMC	Aluminum matrix composite
CTEs	Coefficients of thermal expansion
CUBs	Coal utilization of by-products
JIS	Japanese Industrial Standards
MMC	Metal matrix composite

#### References

1. Rosso, M. (2006). Ceramic and metal matrix composites: routes and properties. *Journal of Materials Processing Technology*, 175(1-3), 364-375.
2. Arifin, A.; Sulong, A.B.; Muhamad, N.; Syarif, J.; and Ramli, M.I. (2015). Powder injection molding of HA/Ti6Al4V composite using palm stearin as based binder for implant material. *Materials & Design*, 65, 1028-1034.
3. Rajan, T.P.D.; Pillai, R.M.; Paia, B.C.; Satyanarayana K.G.; and Rohatgi P.K. (2007). Fabrication and characterisation of Al-7Si-0.35Mg/fly ash metal matrix composites processed by different stir casting routes. *Composites Science and Technology*, 67(15-16), 3369-3377.
4. Elahinia, M.H.; Hashemi, M.; Tabesh, M.; and Bhaduri, S.B. (2012). Manufacturing and processing of NiTi implants: A review. *Progress in Materials Science*, 57(5), 911-946.
5. Alaneme, K.K.; Akintunde, I.B.; Olubambi, P.A.; and Adewale, T.M. (2013). Fabrication characteristics and mechanical behaviour of rice husk ash - alumina reinforced Al-Mg-Si alloy matrix hybrid composites. *Journal of Materials Research and Technology*, 2(1), 60-67.
6. Dewidar, M.M.; Yoon, H.-C.; and Lim, J.K. (2006). Mechanical properties of metals for biomedical applications using powder metallurgy process: A review. *Metals and Materials International*, 12(3), 193-206.

7. Niespodziana, K.; Jurczyk, K.; Jakubowicz, J.; and Jurczyk, M. (2010). Fabrication and properties of titanium-hydroxyapatite nanocomposites. *Materials Chemistry and Physics*, 123(1), 160-165.
8. Viswanatha, B.M.; Kumar, M.P.; Basavarajappa, S.; and Kiran, T. S. (2013). Mechanical property evaluation of A356/SiCP/GR metal matrix composites. *Journal of Engineering Science and Technology (JESTEC)*, 8(6), 754-763.
9. Groover, M.P. (2010). *Fundamentals of modern manufacturing: Materials, processes, and systems*. John Wiley & Sons.
10. Kumar, A.; Lal, S.; and Kumar, S. (2013). Fabrication and characterization of A359/Al<sub>2</sub>O<sub>3</sub> metal matrix composite using electromagnetic stir casting method. *Journal of Materials Research and Technology*, 2(3), 250-254.
11. Kulkarni, S.G.; Meghni, J.V.; and Lal, A. (2014). Effect of fly ash hybrid reinforcement on mechanical property and density of aluminium 356 alloy. *Procedia Materials Science*, 5, 746-754.
12. Huang, Z.; and Yu, S. (2011). Microstructure characterization on the formation of in situ Mg<sub>2</sub>Si and MgO reinforcements in AZ91D/Flyash composites. *Journal of Alloys and Compounds*, 509(2), 311-315.
13. Kutchko, B.; and Kim, A. (2006). Fly ash characterization by SEM-EDS. *Fuel*, 85(17-18), 2537-2544.
14. Yao, Z.T.; Ji, X.S.; Sarker, P.K.; Tang, J.H.; Ge, L.Q.; Xia, M.S.; and Xi, Y.Q. (2015). A comprehensive review on the applications of coal fly ash. *Earth-Science Reviews*, 141, 105-121.
15. Zimmer, A.; and Bergmann, C.P. (2007). Fly ash of mineral coal as ceramic tiles raw material. *Waste Management*, 27(1), 59-68.
16. Visa, M., L.; Andronic; and Duta, A. (2015). Fly ash-TiO<sub>2</sub> nanocomposite material for multi-pollutants wastewater treatment. *Journal of Environmental Management*, 150, 336-43.
17. Fan, L.-J.; and Juang, S.H. (2016). Reaction effect of fly ash with Al-3Mg melt on the microstructure and hardness of aluminum matrix composites. *Materials & Design*, 89, 941-949.
18. Gikunoo, E.; Omotoso, O.; and Oguocha, I.N.A. (2013). Effect of fly ash particles on the mechanical properties of aluminium casting alloy A535. *Materials Science and Technology*, 21(2), 143-152.
19. Rajamannan, B.; Sundaram, C.K.; Viruthagiri, G.; and Shanmugam, N. (2013). Effects of fly ash addition on the mechanical and other properties of ceramic tiles. *International Journal of Latest Research in Science and Technology*, 2(1), 486-491.
20. Jalal, M.; Fathi, M.; and Farzad, M. (2013). Effects of fly ash and TiO<sub>2</sub> nanoparticles on rheological, mechanical, microstructural and thermal properties of high strength self compacting concrete. *Mechanics of Materials*, 61, 11-27.
21. Hashim, J.; Looney, L.; and M.S.J. Hashmi, (1999). Metal matrix composites: production by the stir casting method. *Journal of Materials Processing Technology*, 92-93, 1-7.
22. Sarkar, S.; Sen, S.; Mishra, S.C.; Kudelwar, M.K.; and Mohan, S. (2010). Studies on aluminum - fly-ash composite produced by impeller mixing. *Journal of Reinforced Plastics and Composites*, 29(1), 144-148.

23. Anilkumar, H.C.; and Hebbar, H.S. (2013). Effect of particle size of fly ash on mechanical and tribological properties of aluminium alloy (Al6061) composites and their correlations. *International Journal of Mechanic Systems Engineering*, 3(1), 6-13.
24. Yao, Z.T.; Xia, M.S.; Sarker, P.K.; and Chen, T.(2014). A review of the alumina recovery from coal fly ash, with a focus in China. *Fuel*, 120, 74-85.
25. Kumar, K.R.; Mohanasundaram, K.M.; Subramanian, R.; and Anandavel B. (2014). Influence of fly ash particles on tensile and impact behaviour of aluminium (Al/3Cu/8.5Si) metal matrix composites. *Science and Engineering of Composite Materials*, 21(2), 181-189.
26. Jokhio, M.H., Panhwar, M.I.; and Unar, M.A. (2009). Modeling mechanical properties of cast aluminum alloys. *Mehran University Research Journal of Engineering & Technology*, 8(3), 367-376.
27. Surappa, M.K.; and Rohatgi, P.K. (1981). Preparation and properties of cast aluminium-ceramic particle composites. *Journal of Materials Science*, 16(4), 983-993.
28. Redsten, A.M.; Klier, E.M.; Brown, A.M.; and Dunand, D.C. (1995). Mechanical properties and microstructure of cast oxide-dispersion-strengthened aluminum. *Materials Science and Engineering: A*, 201(1-2), 88-102.
29. Dasgupta, R.; and Meenai, H. (2005). SiC particulate dispersed composites of an Al-Zn-Mg-Cu alloy: Property comparison with parent alloy. *Materials Characterization*, 54(4-5), 438-445.
30. Jokhio, M.H.; Panhwar, M.I.; and Unar, M.A. (2011). Manufacturing of aluminum composite material using stir casting process. *Mehran University Research Journal of Engineering & Technology*, 30(1), 53-64.
31. Callister, W.D.; and Rethwisch D.G. (2009). *Materials science and engineering: An introduction* (8th Ed.). John Wiley And Sons.

# EFFECT OF FLY ASH AS REINFORCEMENT ON MECHANICAL PROPERTIES OF ALUMINUM SCRAP BASED HYBRID COMPOSITE

---

## ORIGINALITY REPORT

---

19%

SIMILARITY INDEX

%

INTERNET SOURCES

15%

PUBLICATIONS

12%

STUDENT PAPERS

---

## PRIMARY SOURCES

---

- 1** Bhandakkar, Ajit, Niraj Kumar, R. C. Prasad, and Shankar M. L. Sastry. "Interlaminar Fracture Toughness of Epoxy Glass Fiber Fly Ash Laminate Composite", Materials Sciences and Applications, 2014. 1%  
Publication

---
- 2** Submitted to Maulana Azad National Institute of Technology Bhopal 1%  
Student Paper

---
- 3** Abhishek Kumar, Shyam Lal, Sudhir Kumar. "Fabrication and characterization of A359/Al<sub>2</sub>O<sub>3</sub> metal matrix composite using electromagnetic stir casting method", Journal of Materials Research and Technology, 2013 1%  
Publication

---
- 4** "Light Metals 2018", Springer Science and Business Media LLC, 2018 1%  
Publication

---

5	Submitted to University of Wollongong Student Paper	1%
6	Submitted to Universiti Tenaga Nasional Student Paper	1%
7	Submitted to University of Babylon Student Paper	1%
8	Krishnan Ravi Kumar, Kothavady Mysamy Mohanasundaram, Ramanathan Subramanian, Balasubramaniam Anandavel. "Influence of fly ash particles on tensile and impact behaviour of aluminium (Al/3Cu/8.5Si) metal matrix composites", Science and Engineering of Composite Materials, 2014 Publication	1%
9	Rao, JB, DV Rao, and NRMR Bhargava. "Development of light weight ALFA composites", International Journal of Engineering Science and Technology, 2011. Publication	1%
10	H. Siddhi Jailani, A. Rajadurai, B. Mohan, T. Sornakumar. "Sliding wear behaviour of Al-Si alloy–fly ash composites produced by powder metallurgy technique", Industrial Lubrication and Tribology, 2017 Publication	1%
11	Himanshu Kala, K.K.S. Mer, Sandeep Kumar.	

---

"A Review on Mechanical and Tribological Behaviors of Stir Cast Aluminum Matrix Composites.", Procedia Materials Science, 2014  
Publication

---

1%

12

P. R. S. Kumar. "Microstructure and mechanical properties of fly ash particle reinforced AA6061 composites produced by press and extrusion", Transactions of the Indian Institute of Metals, 12/2009  
Publication

---

1%

13

Dwivedi, Shashi Prakash, Satpal Sharma, and Raghvendra Kumar Mishra. "Microstructure and mechanical behavior of A356/SiC/Fly-ash hybrid composites produced by electromagnetic stir casting", Journal of the Brazilian Society of Mechanical Sciences and Engineering, 2015.  
Publication

---

<1%

14

Industrial Lubrication and Tribology, Volume 65, Issue 6 (2013-09-28)  
Publication

---

<1%

15

Submitted to Madan Mohan Malaviya University of Technology  
Student Paper

---

<1%

16

Kutchko, B.G.. "Fly ash characterization by SEM-EDS", Fuel, 200612  
Publication

---

<1%



17

Shanbhag, Vignesh. V., Nitin. N. Yalamoori, S. Karthikeyan, R. Ramanujam, and K. Venkatesan. "Fabrication, Surface Morphology and Corrosion Investigation of Al 7075-Al<sub>2</sub>O<sub>3</sub> Matrix Composite in Sea Water and Industrial Environment", *Procedia Engineering*, 2014.

Publication

---

18

Submitted to University of West London

Student Paper

---

19

Kenneth Kanayo Alaneme, Kazeem Oladiti Sanusi. "Microstructural characteristics, mechanical and wear behaviour of aluminium matrix hybrid composites reinforced with alumina, rice husk ash and graphite", *Engineering Science and Technology, an International Journal*, 2015

Publication

---

20

Pankaj Kr. Sharma, Shashi Prakash Dwivedi, Ajay Kumar, Amit Kumar Sharma. "Effect of Magnesium Addition on Mechanical Properties of Al-Fly Ash Green Composite Produced Under Green Ultrasonic Vibration Process", *International Journal of Precision Engineering and Manufacturing-Green Technology*, 2019

Publication

---

21

"Advances in Manufacturing Technology", Springer Nature, 2019

&lt;1%

&lt;1%

&lt;1%

&lt;1%

&lt;1%

22

Sree Manu, K.M., K. Sreeraj, T.P.D. Rajan, R.M. Shereema, B.C. Pai, and B. Arun. "Structure and properties of modified compocast microsilica reinforced aluminum matrix composite", *Materials & Design*, 2015.

Publication

---

23

"Light Metals 2017", Springer Science and Business Media LLC, 2017

Publication

---

24

Chandrakant R Kini .. "INVESTIGATION ON THE BEHAVIOUR OF ALFA COMPOSITE IN PRE AND POST HEAT TREATED CONDITIONS", *International Journal of Research in Engineering and Technology*, 2015

Publication

---

25

Mujibur Rahman, Abhijit Dey, Krishna Murari Pandey. "Machinability of cenosphere particulate–reinforced AA6061 aluminium alloy prepared by compocasting", *Proceedings of the Institution of Mechanical Engineers, Part B: Journal of Engineering Manufacture*, 2017

Publication

---

26

Satpal Sharma, Shashi Prakash Dwivedi. "Effects of waste eggshells and SiC addition on specific strength and thermal expansion of hybrid green metal matrix composite", *Journal*

<1%

<1%

<1%

<1%

<1%

## of Hazardous Materials, 2017

Publication

---

27

Submitted to SVKM International School

Student Paper

<1%

---

28

Ross, Robert B.. "Aluminium Al", Metallic Materials Specification Handbook, 1992.

Publication

<1%

---

29

Avinash Lakshmikanthan, Srikanth Bontha, M. Krishna, Praveennath G. Koppad, T. Ramprabhu. "Microstructure, mechanical and wear properties of the A357 composites reinforced with dual sized SiC particles", Journal of Alloys and Compounds, 2019

Publication

<1%

---

30

Shanmughasundaram Palanisamy, Subramanian Ramanathan, Ravikumar Rangaraj. "Analysis of Dry Sliding Wear Behaviour of Aluminium-Fly Ash Composites: The Taguchi Approach", Advances in Mechanical Engineering, 2013

Publication

<1%

---

31

Yao, Z.T., X.S. Ji, P.K. Sarker, J.H. Tang, L.Q. Ge, M.S. Xia, and Y.Q. Xi. "A comprehensive review on the applications of coal fly ash", Earth-Science Reviews, 2015.

Publication

<1%

---

Submitted to Indian School of Mines

33

Juang, Shueiwan H., Liang-Jing Fan, and Hung Po Ou Yang. "Influence of preheating temperatures and adding rates on distributions of fly ash in aluminum matrix composites prepared by stir casting", International Journal of Precision Engineering and Manufacturing, 2015.

Publication

&lt;1%

34

Submitted to Visvesvaraya Technological University

Student Paper

&lt;1%

35

Mostafa Jalal, Alireza Pouladkhan, Omid Fasihi Harandi, Davoud Jafari. "Comparative study on effects of Class F fly ash, nano silica and silica fume on properties of high performance self compacting concrete", Construction and Building Materials, 2015

Publication

&lt;1%

36

Submitted to Jawaharlal Nehru Technological University

Student Paper

&lt;1%

37

Metallic Materials Specification Handbook, 1992.

Publication

&lt;1%

38

Submitted to National Institute of Technology,  
Rourkela

Student Paper

<1%

---

39

Jing Li, Xinguo Zhuang, Xavier Querol, Oriol  
Font, Natalia Moreno. "A review on the  
applications of coal combustion products in  
China", International Geology Review, 2017

Publication

<1%

---

Exclude quotes Off

Exclude matches Off

Exclude bibliography On