

Effect of fly ash as reinforcement on mechanical properties of aluminum scrap based hybrid composite

By Diah Kusuma Pratiwi

EFFECT OF FLY ASH AS REINFORCEMENT ON MECHANICAL PROPERTIES OF ALUMINUM SCRAP BASED HYBRID COMPOSITE

AMIR ARIFIN, RIMAN SIPAHUTAR, DIAH KUSUMA PRATIWI,
IRWIN BIZZY, DWI PURBA, GUNAWAN*

12

Department of Mechanical Engineering, Faculty of Engineering, Universitas Sriwijaya,
30662 Indralaya, Sumatera Selatan, Indonesia
*Corresponding Author: gunawan@unsri.ac.id

Abstract

37

Aluminum matrix composite (AMC) has been widely used in various industries such as Automotive, aerospace and marine. One of the constraints to fabricate AMC is the high costs involved. Fly ash is a coal combustion waste that have considerable potential as an alternative material for the manufacture of AMC. In this work, AMC was fabricated through stir casting methods, alumina and fly ash are utilized as reinforcement. Mechanical properties of the composite were analysed based on the results of impact test, tensile test and hardness test. Impact test revealed 28 the maximum energy absorbed of the AMC is 14.224 Joule with composition 8 wt% alumina and 12 wt% fly ash. Moreover, tensile strength and hardness testing result on AMC showed the similar tendency. Mechanical properties increase linearly with increasing the addition of fly ash. The maximum value was obtained at 133.74 MPa and 65.37 BHN for tensile strength and hardness number, respectively. Microstructural results also showed that there was grain refinement to the addition of fly ash composition, which supports the mechanical properties result.

Keywords: Aluminum matrix composite, Aluminum alloy, Fly ash, Mechanical properties, Stir casting.

1. Introduction

Recently, with the rapid technological achievement in aerospace, medical, automotive and marine led to huge demand in the materials having superior properties [1]. The mechanical properties of material are main consideration in selection material to utilize in a structure. Improvement of mechanical properties such as hardness and strength has been a major goal in material engineering research, especially in the field of metal matrix composite. Some efforts have been made by researchers to produce superior materials with various fabrication methods, such as forming, casting and powder metallurgy [2 - 8].

Composite is combining two or more micro/macro matter having different composition that consists of a matrix as base material and reinforcement as reinforcement material [9]. Rapid technological development with extreme in operational condition tends to require a superior material. Metal matrix composite (MMC) is one of the solutions to overcome this problem. MMC consists of metal and hard materials as matrix and reinforced, respectively. A combination of two materials in the design of MMC is expected to produce the desired mechanical properties [10].

Generally MMC has some advantage properties such as higher specific strength, weight reduction, excellent wear resistance, lower coefficients of thermal expansion (CTEs) and high vibration damping [11]. Metal matrix composite in term aluminum as matrix is recognized as Aluminum Matrix Composites (AMC). AMC have been widely used for aerospace structures, automotive and marine industry [12]. Manufacturing of conventional AMC tend costly in term processes and material usage, thus restricting in terms of its usage in the structure.

Combustion process of coal in power plants to generate electricity always produced solid coal utilization by-products (CUBs) which is produced by non-combustible part of the coal. Physical and chemical characteristics of CUB is unique depend on parameters process during combustion process; moreover it has complex matter such as fly ash, bottom ash, slag and gas [13, 14]. CUBs have become interesting issue for research due to give great impact to environment especially for surrounding power plant [14, 15]. Fly ash is one component of the CUBs that always present during combustion coal process. It separated from exhaust gases of combustion process of coal, Fly ash comprising to oxide and metal oxides of silicon, aluminum, iron, and calcium in natural ceramic formed [16, 17].

Some efforts have been performed to find potential material as alternative reinforcement for AMC. Based on previous work that reported some author, fly ash can be strong candidate as alternative reinforcement for AMC [11, 18-20]. Kulkarni et al. [11] reported that compressive strength of aluminum 356 alloys increased with additional fly ash and alumina. Kumar et al. [10] also reported hardness and tensile strength increase linearly with increasing the weight fraction of Al_2O_3 . Gikunoo et al. [18] reported that microhardness, tensile strength and impact of aluminum A353 decreased with increasing weight percentage of fly ash.

Stir casting is standard method to produce aluminum metal composite, involving of a melt matrix material followed by the introduction of reinforcement material into the melt. Stirring process is performed during mixing matrix and reinforce material to obtain homogeneous distribution of reinforcement material. Some factors should be consider to achieve the high quality of MMC such as the

uniformity of the particle distribution of reinforcing materials, porosity MMC and also the bond between the substance [21].

In this work, stir casting was performed to fabricate aluminum matrix composite (AMC) with fly ash and Al_2O_3 as hybrid reinforcement. Some of earlier investigations showed the mechanical properties of aluminum composite reinforced with single particulate material such as SiC, Al_2O_3 , and graphite. Moreover, development of hybrid composite that compose two or more reinforced material including Al_2O_3 and fly ash is very interesting research area. Fly ash is a hazardous material that available abundantly and cheap (approximately 1/30 of SiC particles) and utilization can further reduce the negative impact. The objective of this work is to investigate the effects of fly ash on mechanical properties of Al-3.38Zn alloy. The mechanical properties were assessed by impact, tensile strengths and hardness testing.

2. Experimental Procedure

The fly ash is supplied by power plants located in the area of Tanjung Enim in South Sumatera Province, Indonesia. It has 110 mesh size with irregular shape. Al_2O_3 has size 731 nm with irregular shape. The chemical composition of both fly ash and alumina can be seen in Table 1.

Table 1. Typical chemical composition of fly ash.

Materials	Chemical compositions (%)							
	SiO_2	Al_2O_3	Fe_2O_3	TiO_2	CaO	MgO	K_2O	others
Fly Ash	57.95	28.15	4.75	0.93	3.74	1.73	0.62	2.13
Alumina	0.018	99.70	0.02	0.006	-	-	-	0.26

Metal matrix composites, processed by stirring casting route were conducted in this work. In the present experimental investigation Al-3.38%Zn alloys are used as a matrix material, meanwhile Al_2O_3 (8 wt%) and Fly ash (4, 8 and 12 wt%) used as hybrid reinforce. The chemical composition of Al-3.38%Zn alloys for this work is given in Table 2.

Table 2 Typical chemical compositional limits of alloying elements in Al-3.38Zn alloy

Element*	Zn	Cu	Fe	Pb	Ni	Ti	Sn
wt%	3.38	1.83	1.098	0.161	0.094	0.071	0.036

*Balance = aluminum

Al-3.38%Zn alloys was melted in a crucible at 700 °C which is more than 50 °C above liquidus temperature of the matrix alloy. Before being added to the molten aluminum alloy, Fly ash is heated at 400 °C for 1 hour to remove the gases and water vapour contained in fly ash [22, 23]. The molten aluminum alloy was stirred until generate vortex, during molten aluminum alloy was stirred preheat fly ash was added slowly. Stirring the aluminum solution is intended to facilitate for uniform distribution of fly ash, which has a density that is lighter than aluminum alloys [3].

Figure 1 shows the design sample for tensile, hardness and impact strength refers to the standard JIS Z 2201 and JIS Z 2202, respectively. All of mechanical properties test sample were obtained by cutting from the as cast sample. Figure 2 shows stir casting process that has been done to melt Al-3.38% Zn alloys, mixing blade is 350 rpm was generated by the electric motor with speed control equipment.

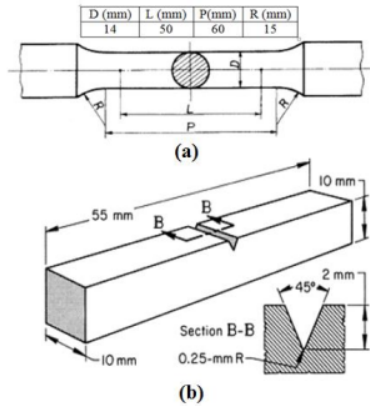

Fig. 1. Specimen test based on Japanese Industrial Standards; (a) JIS Z 2201 and (b) JIS Z 2202.

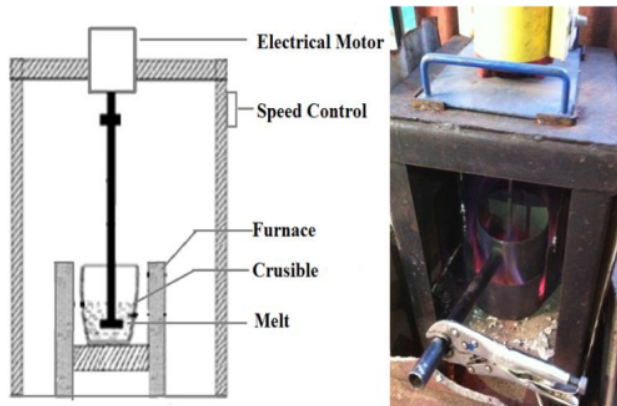

Fig. 2. Schematic of stir casting process.

3. Results and Discussion

Figure 3 shows the specimen for impact, tensile and hardness test that produced using stir casting methods. Mechanical Properties of Al-3.38Zn alloy hybrid composite analysis of mechanical properties carried out through tensile testing, hardness and impact testing. The toughness of material is one of important properties for engineering material. Measurement material toughness is usually

determined based on the consumption of energy that can be absorbed before the material is fracture.

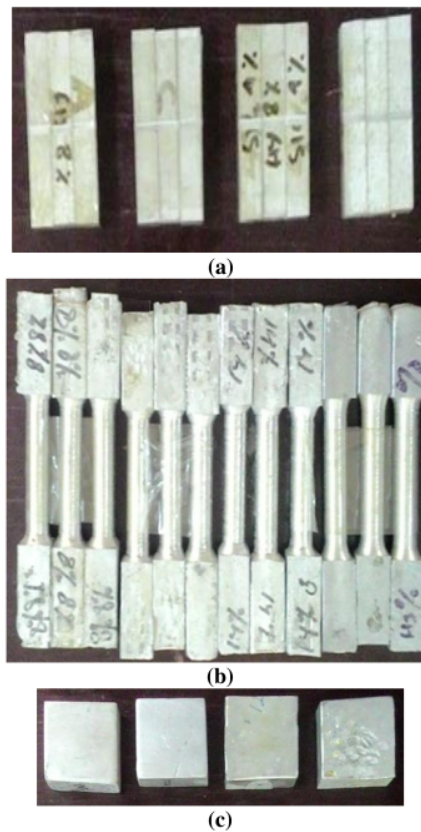

Fig. 3. Cast sample for mechanical testing.
(a) impact test (b) tensile test and (c) hardness test.

Figure 4 shows the variation of Charpy impact energy with increasing fly ash content (wt%). It can be observed that the energy absorbed in fracturing the specimens increased linearly with increases in fly ash content. It is accordance that have been reported by Kumar et al. [10], that the addition of a weight percentage of fly ash will increase the mechanical properties of aluminum alloys.

Maximum energy absorbed (14.22 Joule) was obtained at composition of 12 wt % fly ash and 8 wt% Al_2O_3 while AMC without fly ash content has minimum energy Absorbed (5.55 J).

Variation of tensile strength with weight percentage of fly ash content is shown in Fig. 5. Tensile strength of composite increase linearly with increasing of fly ash content. This is describing clearly that fly ash particulate influence tensile strength

of aluminum alloy. The existence of fly ash particles in the aluminum matrix act as an obstacle for the movement of dislocations and which strengthen the aluminum composite. Based on the results of tensile test that maximum value of tensile strength was obtain at composition 12 wt% fly ash while minimum value of tensile strength without fly ash content.

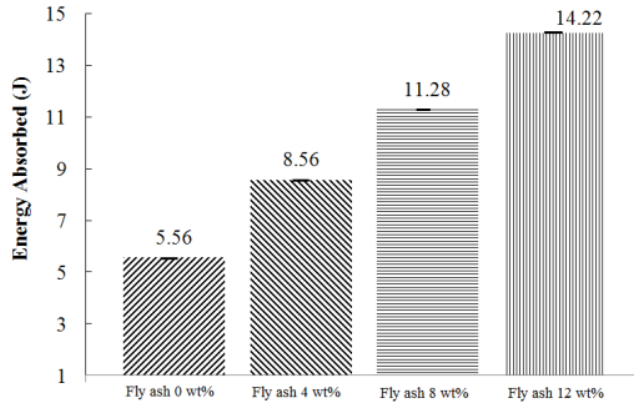

Fig. 4. Variations of Charpy energy with composition of 8 wt% Alumina and various weight percentage of fly ash content.

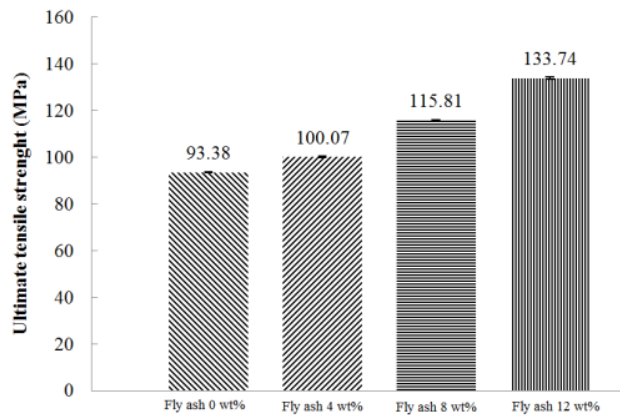

Fig. 5. Variation of tensile strength with composition of 8 wt% Alumina and various weight percentage of fly ash content.

Ceramics generally tend to have a higher hardness value than the metal. Fly ash comprising to combination of main types of ceramics such as SiO₂, Al₂O₃, Fe₂O₃, CaO, MgO and K₂O proved to increase the hardness number of AMC [23, 24]. Figure 6 shows the addition of fly ash weight percentage increasing proportionally AMC hardness number.

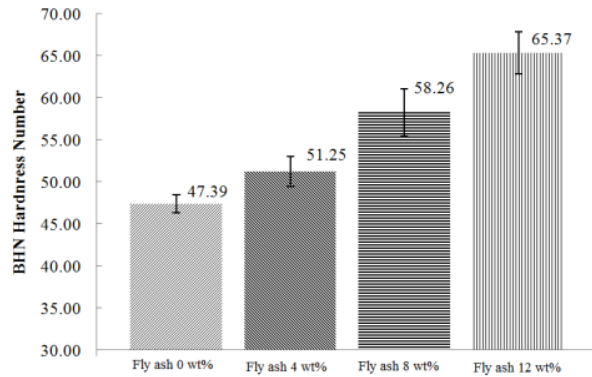

Fig. 6. Variations of hardness with composition of 8 wt% Alumina and various weight percentages of fly ash content.

Figure 7 shows the elongation of Al-3.38%Zn alloys with various weight percentage of fly ash. Maximum ductility of Al-3.38%Zn alloys was obtained at 12 wt% fly ash with elongation value 8.27%. The elongation of the composites increased with an increase in the weight fraction of the fly ash. Fraction volume and interface bonding between matrix material and reinforcement play important role to influence elongation of aluminum matrix composite [25]. Moreover, the existence of reinforcement particles in Al-3.38%Zn alloy as constraints function on the plastic flow of the matrix.

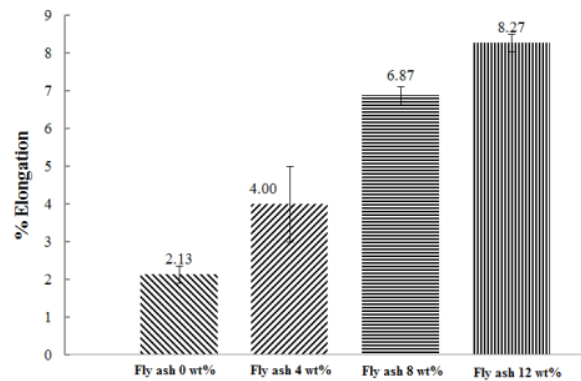

Fig. 7. Influence of fly ash percentage on the elongation Al-3.38Zn-1.83Cu alloy hybrid composite.

The effect of particulate ceramics as reinforcement in metal matrix composite (MMC) to the elongation is still being debated, which some researchers believe on existing of an influence to improve and *vice versa*. Table 3 shows the effect of adding ceramic as the reinforcement of the MMC, which improves elongation.

Table 3. Comparison elongation results of the current study with other researchers.

Matrix Composition	Reinforcement	Process	Elongation (max)	Ref.
Al-Cu-Zn-Mg	Al ₂ O ₃	Stir Casting	17%	[26]
Al-11.8%, Si 1.4	Al ₂ O ₃	Vertex	6%	[27]
30 4.12% Cu, 1.94Mg	Al ₂ O ₃	Vertex	3.2%	[28]
Al 1.6% Cu, 2.5% Mg, 4.4% Zn	SiC	Stir casting	1.56%	[29]
Al 2.7% Cu, 1.8% Mg, 4.40% Zn	SiC	Stir casting	17%	[30]
Al-3.38% Zn-1.83% Cu	Al ₂ O ₃ & Fly Ash	Stir casting	8.27%	Current research

In the case of aluminum matrix composite distribution of reinforcement particle in aluminum matrix have significant contribution on mechanical properties of composite. Distribution of fly ash in aluminum matrix was observed by optical microscope Olympus STM6-LM optical microscope. Figure 8 illustrates the typical microstructure of microstructure of Al-3.38%Zn alloys reinforced alumina and fly ash. Figs. 8(a) and (b) show the increasing weight percentage of fly ash affects the grain refinement of the microstructure of Al-3.38% Zn alloys. Grain refinement occurs due to the addition of fly ash, which comprising to the ceramic element with high melting. The existence of ceramic element functioning as the initial nucleus during the solidification Al-3.38% Zn alloys. According to Jokhio [30] increasing weight percentages of Al₂O₃ on the aluminum alloy increased strength and ductility value up to 10%. In this work, the samples aluminum alloy with 8 wt% of alumina and fly ash vary from 0 to 12 wt% was added into aluminum alloy. In other word alumina portion increased by adding fly ash. The existence of Al₂O₃ powders perform to grain refinement of aluminum casting composite during solidification process.

Grain refinement plays a critical role in affecting the mechanical properties of materials such as hardness, tensile strength and impact resistance [31]. Hardness, tensile strength and impact test previously revealed that Al-3.38% Zn alloys composite with a finer grain size has maximum value. Moreover, on Fig. 8(b) was found the uniform distribution of reinforcement elements. The present of reinforcement elements would prevent dislocation movement and thus increase mechanical properties.

Generally, it is well known that the mechanical strength (i.e., Young's modulus, yield stress, tensile strength and fracture stress) of AMC of ceramic-reinforced was higher than its pure alloys and improve with percentage ceramic materials portion. The mechanism and failure mode of aluminum matrix composites can be obtained from fractographic analysis of tensile testing. The tensile fracture surface characteristic consisting of numerous dimples as shown in Figs. 9(a) to (d). It can be observed that the dimples formation on the surface increased as increasing fly ash particles in which large dimples is observed in Fly Ash 12 wt%. The formation of dimples indicates a plastic deformation. It is suggested that an extensive plastic deformation formed the dimples associated with the reinforcing particles. This is in an accordance with the elongation and the energy absorption result. Reinforced composite materials leading to a higher energy absorption that showed increasing energy consumption for plastic deformation.

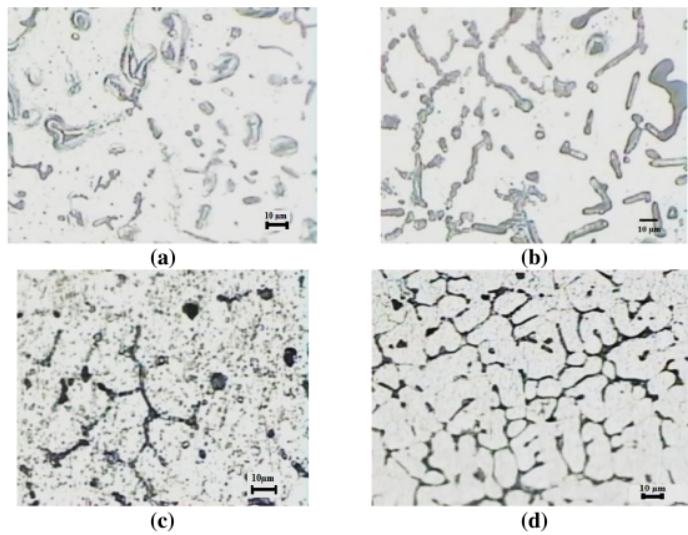

Fig. 8. Microstructure of Al-3.38%Zn alloys reinforced alumina and fly ash; (a) Alumina 8 wt% Fly Ash 0 wt% , (b) Alumina 8 wt% Fly Ash 4 wt% , (c) Alumina 8 wt% , Fly Ash 8wt% and (d) Alumina 8 wt% , Fly Ash 12 wt%.

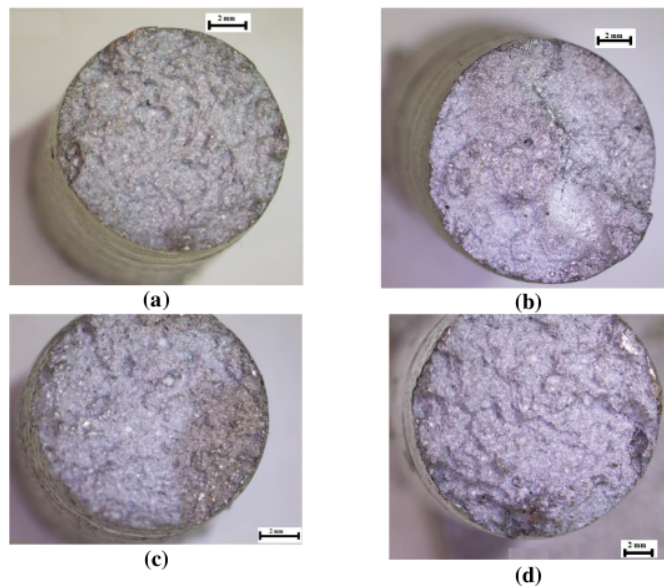

Fig. 9. Macrostructure fractography of Al-3.38%Zn alloys reinforced alumina and fly ash; (a) Alumina 8 wt% Fly Ash 0 wt% , (b) Alumina 8 wt% Fly Ash 4 wt% , (c) Alumina 8 wt% , Fly Ash 8wt% and (d) Alumina 8 wt% , Fly Ash 12 wt%

4. Conclusions

In summary, Al-3.38%Zn alloys hybrid composite with alumina 8 wt% and various composition of fly ash (0, 4, 8 and 12 wt%) was successfully fabricated via stir casting method. In this work the addition of fly ash powder into Al-3.38%Zn alloys + 8 wt% Al₂O₃ is able to enhance the mechanical properties of the AMC in this case the value of hardness, energy absorption and tensile strength. Results revealed that the proportional increase occurred in the addition of fly ash ranges from 0 - 12 wt% by weight. According to analysis using an optical microscope that the addition of fly ash plays a critical role on the grain refinement of Al-3.38%Zn alloys. The fracture surface on the specimen was observed many dimples with increasing weight percentage of fly ash. Dimple formation on the fracture surface indicates the tendency of ductile material properties. It is also demonstrated and accordance with elongation measurement results of specimen tensile. Overall results showed that fly ash has great potential as a reinforcement of aluminum matrix composite (AMC).

16

Acknowledgment

The authors would like to convey their great appreciation to Universitas Sriwijaya for supporting this research.

Nomenclatures

AMC	Aluminum matrix composite
CTEs	Coefficients of thermal expansion
CUBs	Coal utilization of by-products
JIS	Japanese Industrial Standards
MMC	Metal matrix composite

References

1. Rosso, M. (2006). Ceramic and metal matrix composites: routes and properties. *Journal of Materials Processing Technology*, 175(1-3), 364-375.
2. Sun, A.; Sulong, A.B.; Muhamad, N.; Syarif, J.; and Ramli, M.I. (2015). Powder injection molding of HA/Ti6Al4V composite using palm stearin as binder for implant material. *Materials & Design*, 65, 1028-1034.
3. Rajan, T.P.D.; Pillai, R.M.; Paia, B.C.; Satyanarayana K.G.; and Rohatgi P.K. (2007). Fabrication and characterisation of Al-7Si-0.35Mg/fly ash metal matrix composites processed by different stir casting routes. *Composites Science and Technology*, 67(15-16), 3369-3377.
4. Elahinia, M.H.; Hashemi, M; Tabesh, M.; and Bhaduri, S.B. (2012). Manufacturing and processing of NiTi implants: A review. *Progress in Materials Science*, 57(5), 911-946.
5. Alaneme, K.K.; Akintunde, I.B.; Olubamiji, A.; and Adewale, T.M. (2013). Fabrication, characteristics and mechanical behaviour of rice husk ash - alumina reinforced Al-Mg-Si alloy matrix hybrid composites. *Journal of Materials Research and Technology*, 2(1), 60-67.
6. Dewidar, M.M.; Yoon, H.-C.; and Lim, J.K. (2006). Mechanical properties of metals for biomedical applications using powder metallurgy process: A review. *Metals and Materials International*, 12(3), 193-206.

- 6
7. Niespodziana, K.; Jurczyk, K.; Jakubowicz, J.; and Jurczyk, M. (2010). Fabrication and properties of titanium-hydroxyapatite nanocomposites. *Materials Chemistry and Physics*, 123(1), 160-165.
8. Viswanatha, B.M.; Kumar, M.P.; Basavarajappa, S. 45 and Kiran, T. S. (2013). Mechanical property evaluation of A356/SiCP/GR metal matrix composites. *Journal of Engineering Science and Technology (JESTEC)*, 8(6), 754-763.
- 22
9. Groover, M.P. (2010). *Fundamentals of modern manufacturing: Materials, processes, and systems*. John Wiley & Sons 24
10. Kumar, A.; Lal, S.; and Kumar, S. (2013). Fabrication and characterization of 46 59/Al₂O₃ metal matrix composite using electromagnetic stir casting method. *Journal of Materials Research and Technology*, 2(3), 2 41 254.
11. Kulkarni, S.G.; Meghni, J.V; and Lal, A. (2014). Effect of fly ash hybrid reinforcement on mechanical property and density of aluminium 356 alloy. *Procedia Materials Science*, 5, 746-754.
12. Huang, Z.; and Yu, S. (2011). Microstructure characterization on the formation of in situ Mg₂Si and MgO reinforcements in AZ91D/Flyash composites. *Journal of Alloys and Compounds*, 509(2), 311-315.
- 18
13. Kutchko, B.; and Kim, A. (2006). Fly ash characterization by SEM-EDS. *Fuel*, 85(17-18), 2537-2544.
14. Yao, Z.T.; Ji, X.S.; Sarker, P.K.; Tang, J.H.; Ge, L.Q.; Xia, M.S.; and Xi, Y.Q. (2015). A comprehensive review on the applications of coal fly ash. *Earth-Science Reviews*, 141, 105-121.
- 8
15. Zimmer, A.; and Bergmann, C.P. (2007). Fly ash of mineral coal as ceramic tiles 10 material. *Waste Management*, 27(1), 59-68.
16. Visa, M., L.; Andronic; and Duta, A. (2015). Fly ash-TiO₂ nanocomposite material for multi-pollutants wastewater treatment. *Journal of Environmental Management*, 150, 336-43.
17. Fan, L.-J.; and Juang, S.H. (2016). Reaction effect of fly ash with Al-3Mg melt on the microstructure and hardness of aluminum matrix composites. *Materials & Design*, 89, 941-949.
18. Gikunoo, E.; Om 4 oso, O.; and Oguocha, I.N.A. (2013). Effect of fly ash particles on the mechanical properties of aluminium casting alloy A535. *Materials Science and Technology*, 21(2), 143-152.
19. Rajama 11 n, B.; Sundaram, C.K.; 21 uthagiri, G.; and Shanmugam, N. (2013). Effects of fly ash addition on the mechanical and other properties of ceramic tiles. *International Journal of Latest Research in Science and Technology*, 2(1), 486-491.
20. Jalal, M.; Fathi, M.; and Farzad, M. (2013). Effects of fly ash and TiO₂ nanoparticles on rheological, mechanical, microstructural and thermal properties 5 high strength self compacting concrete. *Mechanics of Materials*, 61, 11-27.
21. Hashim, J.; Looney, L.; and M.S.J. Hashmi, (1999). Metal matrix composites: production by the stir casting method. *Journal of Materials Processing 9 hnology*, 92-93, 1-7.
- 9
22. Sarkar, S.; Sen, S.; Mishra, S.C.; Kudelwar, M.K.; and Mohan, S. (2010). Studies on aluminum - fly-ash composite produced by impeller mixing. *Journal of Reinforced Plastics and Composites*, 29(1), 144-148.

23. Anilkumar, H.C.; and Hebbar, H.S. (2013). Effect of particle size of fly ash on mechanical and tribological properties of aluminium alloy (Al6061) composites and their correlations. *International Journal of Mechanic Systems Engineering*, 3(1), 6-13.
24. Yao, Z.T.; Xia, M.S.; Sarker, P.K.; and Chen, T.(2014). A review of the alumina recovery from coal fly ash, with a focus in China. *Fuel*, 120, 74-85.
25. Kumar, K.R.; Mohanasundaram, K.M.; Subramanian, R.; and Anandavel B. (2014). Influence of fly ash particles on tensile and impact behaviour of aluminium (Al/3Cu/8.5Si) metal matrix composites. *Science and Engineering of Composite Materials*, 21(2), 181-189.
26. Jokhio, M.H., Panhwar, M.I.; and Unar, M.A. (2009). Modeling mechanical properties of cast aluminum alloys. *Mehran University Research Journal of Engineering & Technology*, 8(3), 367-376.
27. Surappa, M.K.; and Rohatgi, P.K. (1981). Preparation and properties of cast aluminium-ceramic particle composites. *Journal of Materials Science*, 16(4), 987-993.
28. Redsten, A.M.; Klier, E.M.; Brown, A.M.; and Dunand, D.C. (1995). Mechanical properties and microstructure of cast oxide-dispersion-strengthened aluminum. *Materials Science and Engineering: A*, 201(1-2), 88-102.
29. Dasgupta, R.; and Meenai, H. (2005). SiC particulate dispersed composites of an Al-Zn-Mg-Cu alloy: Property comparison with parent alloy. *Materials Characterization*, 54(4-5), 438-445.
30. Jokhio, M.H.; Panhwar, M.I.; and Unar, M.A. (2011). Manufacturing of aluminum composite material using stir casting process. *Mehran University Research Journal of Engineering & Technology*, 30(1), 53-64.
31. Callister, W.D.; and Rethwisch D.G.(2009). *Materials science and engineering: An introduction* (8th Ed.). John Wiley And Sons.

Effect of fly ash as reinforcement on mechanical properties of aluminum scrap based hybrid composite

ORIGINALITY REPORT

17%

SIMILARITY INDEX

PRIMARY SOURCES

- | | | |
|---|---|---------------|
| 1 | etda.libraries.psu.edu
Internet | 29 words — 1% |
| 2 | ipindexing.com
Internet | 29 words — 1% |
| 3 | N Nagabhushana, S Rajanna, Mahantayya Mathapati, M R Ramesh, Praveennath G Koppad, Nagaraja C Reddy. " Microstructure and tribological characteristics of APS sprayed NiCrBSi/flyash cenosphere/Cr O and NiCrBSi/flyash cenosphere/Mo composite coatings at elevated temperatures ", Materials Research Express, 2019
Crossref | 27 words — 1% |
| 4 | bura.brunel.ac.uk
Internet | 27 words — 1% |
| 5 | www.ijert.org
Internet | 27 words — 1% |
| 6 | cer.ihtm.bg.ac.rs
Internet | 24 words — 1% |
| 7 | Shanmuga Priyan V.G., S. Kanmani Subbu. "Effect of ultrasonic treatment during stir casting on mechanical properties of AA6063-SiC composites", Materials Chemistry and Physics, 2022 | 23 words — 1% |

-
- 8 repositorio.unican.es 23 words — 1%
Internet
-
- 9 Shankar Subramanian, Balaji Arunachalam, Kawin Nallasivam, Alokesh Pramanik. "Investigations on tribo-mechanical behaviour of Al-Si10-Mg/sugarcane bagasse ash/SiC hybrid composites", China Foundry, 2019 22 words — 1%
Crossref
-
- 10 li01.tci-thaijo.org 22 words — 1%
Internet
-
- 11 R A Salman, S A Ajeel, N K Zedin. " Influence of Sulphate and Chlorides Acidic Media on Mechanical and Corrosion Behavior of Fly Ash Particulate Reinforced 2024 Al/TiO Composites ", IOP Conference Series: Materials Science and Engineering, 2020 21 words — 1%
Crossref
-
- 12 Gunawan, Amir Arifin, Irsyadi Yani, Sufran Damar Arian. " The Fabrication Porous Scaffold Using Sweet Potato Starch as a Natural Space Holder ", Journal of Physics: Conference Series, 2019 20 words — 1%
Crossref
-
- 13 Pragma Shandilya, P.K. Jain, N.K. Jain. "RSM and ANN Modeling Approaches For Predicting Average Cutting Speed During WEDM of SiCp/6061 Al MMC", Procedia Engineering, 2013 20 words — 1%
Crossref
-
- 14 B KUTCHKO, A KIM. "Fly ash characterization by SEM-EDS", Fuel, 2006 19 words — < 1%
Crossref
-
- 15 es.scribd.com

19 words — < 1%

16 A Arifin, Gunawan, I Yani. "Failure analysis of AISI 304 stainless steel pipeline transmission a petrochemical plant", IOP Conference Series: Materials Science and Engineering, 2020
Crossref

17 Edward J. Cheal, Myron Spector, Wilson C. Hayes. "Role of loads and prosthesis material properties on the mechanics of the proximal femur after total hip arthroplasty", Journal of Orthopaedic Research, 1992
Crossref

18 espace.curtin.edu.au
Internet

19 A. Abhishek Krishna Sai, M. Chandrasekaran, T. Vinod Kumar, R. Pugazhenth. "Study the enhanced mechanical properties of Al/B4C metal matrix composite", Materials Today: Proceedings, 2022
Crossref

20 Arifin, Amir, Abu Bakar Sulong, Norhamidi Muhamad, Junaidi Syarif, and Mohd Ikram Ramli. "Powder injection molding of HA/Ti6Al4V composite using palm stearin as based binder for implant material", Materials & Design, 2015.
Crossref

21 paperity.org
Internet

22 www.hdko.hr
Internet

23 Doddamani, MR, and SM Kulkarni. "Dynamic response of fly ash reinforced functionally graded rubber composite sandwiches - a Taguchi approach", International Journal of Engineering Science and Technology, 2011. 14 words — < 1%

Crossref

24 Rajesh, S., B. VijayaRamnath, C. Elanchezian, N. Aravind, V. Vijai Rahul, and S. Sathish. "Analysis of Mechanical Behavior of Glass Fibre/ Al₂O₃-SiC Reinforced Polymer Composites", Procedia Engineering, 2014. 14 words — < 1%

Crossref

25 Sharma, P., D. Khanduja, and S. Sharma. "Tribological and mechanical behavior of particulate aluminum matrix composites", Journal of Reinforced Plastics and Composites, 2014. 14 words — < 1%

Crossref

26 D.C. Dunand, A.M. Jansen. "Creep of metals containing high volume fractions of unshearable dispersoids—Part I. Modeling the effect of dislocation pile-ups upon the detachment threshold stress", Acta Materialia, 1997. 13 words — < 1%

Crossref

27 Dorozhkin, Sergey V.. "Biocomposites and Hybrid Biomaterials Based on CaPO₄", Calcium Orthophosphate-Based Bioceramics and Biocomposites, 2016. 13 words — < 1%

Crossref

28 Pankaj Kr. Sharma, Shashi Prakash Dwivedi, Ajay Kumar, Amit Kumar Sharma. "Effect of Magnesium Addition on Mechanical Properties of Al-Fly Ash Green Composite Produced Under Green Ultrasonic Vibration Process", International Journal of Precision Engineering and Manufacturing-Green Technology, 2019. 10 words — < 1%

Crossref

29 Satish Kumar Thandalam, Subramanian Ramanathan, Shalini Sundarrajan. "Synthesis, microstructural and mechanical properties of ex situ zircon particles (ZrSiO₄) reinforced Metal Matrix Composites (MMCs): a review", Journal of Materials Research and Technology, 2015
Crossref 10 words — < 1%

30 docplayer.net
Internet 10 words — < 1%

31 "Human-Centered Technology for a Better Tomorrow", Springer Science and Business Media LLC, 2022
Crossref 9 words — < 1%

32 Hui Xie, Jinze Lv. "Dendrite Refinement and Improved Mechanical Properties of SiC/TiC/Al Hybrid Nanocomposites", Advances in Materials Science and Engineering, 2022
Crossref 9 words — < 1%

33 Mujibur Rahman, Abhijit Dey, Krishna Murari Pandey. "Machinability of cenosphere particulate-reinforced AA6061 aluminium alloy prepared by comocasting", Proceedings of the Institution of Mechanical Engineers, Part B: Journal of Engineering Manufacture, 2017
Crossref 9 words — < 1%

34 Veerasimman Arumugaprabu, Deepak Joel Johnson R., Pragatheeswaran R.. "chapter 13 Effective Utilization of Industrial Wastes for Preparing Polymer Matrix Composites", IGI Global, 2019
Crossref 9 words — < 1%

35 www.coursehero.com
Internet 9 words — < 1%

36 Saikat Das, R. Govinda Rao, Prasanta Kumar Rout. "Thermal Kinetics of SiCp Reinforced AA7075 Alloy Composite", Silicon, 2021
Crossref 8 words — < 1%

37 Sharma, Anand, M.P. Garg, Kapil Kumar Goyal, and Anish Kumar. "Investigation of wire electrical discharge machining of ZrSiO₄/Al 6063 MMC", International Journal of Machining and Machinability of Materials, 2016.
Crossref 8 words — < 1%

38 ir.lib.uth.gr
Internet 8 words — < 1%

39 tfzr.rs
Internet 8 words — < 1%

40 Sazzad Bin-Shafique. "Leachate Concentrations from Water Leach and Column Leach Tests on Fly Ash-Stabilized Soils", Environmental Engineering Science, 01/2006
Crossref 7 words — < 1%

41 Gupta, Nikhil, Dung D. Luong, and Kyu Cho. "Magnesium Matrix Composite Foams—Density, Mechanical Properties, and Applications", Metals, 2012.
Crossref 6 words — < 1%

42 I. Dinaharan, N. Murugan. "Influence of Friction Stir Welding Parameters on Sliding Wear Behavior of AA6061/0-10 wt.% ZrB₂ in-situ Composite Butt Joints", Journal of Minerals and Materials Characterization and Engineering, 2011
Crossref 6 words — < 1%

43 M. Jeyakumar, S. Kumar, G. S. Gupta. 6 words — < 1%
"Microstructure and Properties of the Spray-
Formed and Extruded 7075 Al Alloy", Materials and
Manufacturing Processes, 2010
Crossref

44 Metallic Materials Specification Handbook, 1992. 6 words — < 1%
Crossref

45 Senthilkumar, M., S. Saravanan, and S. Shankar. 6 words — < 1%
"Dry sliding wear and friction behavior of
aluminum-rice husk ash composite using Taguchi's technique",
Journal of Composite Materials, 2014.
Crossref

46 Tao Yi, Changchun Zhou, Liang Ma, Lina Wu, 6 words — < 1%
Xiujuan Xu, Linxia Gu, Yujiang Fan, Guang Xian,
Hongyuan Fan, Xingdong Zhang. "Direct 3 - D printing of Ti -
6Al - 4V/HA composite porous scaffolds for customized
mechanical properties and biological functions", Journal of
Tissue Engineering and Regenerative Medicine, 2020
Crossref

EXCLUDE QUOTES OFF

EXCLUDE SOURCES OFF

EXCLUDE BIBLIOGRAPHY OFF

EXCLUDE MATCHES OFF