

The effect of w/c ratio on microstructure of self-compacting concrete (SCC) with sugarcane bagasse ash (SCBA)

by Saloma Hasyim

Submission date: 05-Oct-2019 11:39AM (UTC+0700)

Submission ID: 1186481245

File name: 50006_2017_Hanafiah,_Saloma,_Victor,_Khoirunnisa_Nur_Amalina.pdf (1.18M)

Word count: 3238

Character count: 14795

The effect of w/c ratio on microstructure of self-compacting concrete (SCC) with sugarcane bagasse ash (SCBA)

Hanafiah, Saloma, Victor, and Khoirunnisa Nur Amalina

Citation: [AIP Conference Proceedings](#) **1903**, 050006 (2017);

View online: <https://doi.org/10.1063/1.5011545>

View Table of Contents: <http://aip.scitation.org/toc/apc/1903/1>

Published by the [American Institute of Physics](#)

The Effect of w/c Ratio on Microstructure of Self-Compacting Concrete (SCC) with Sugarcane Bagasse Ash (SCBA)

Hanafiah^{1, a)}, Saloma^{1, b)}, Victor^{1, c)} and Khoirunnisa Nur Amalina^{1, d)}

¹*Civil Engineering Department, Faculty of Engineering, Sriwijaya University, Palembang-Prabumulih KM. 32 Street, Ogan Ilir District, Sumatera Selatan, Indonesia*

^{b)}Corresponding author: saloma_571@yahoo.co.id

^{a)}hanafiah_dr@yahoo.com.sg

^{c)}Victorhuang17_yahoo.co.id

^{d)}knamalina@gmail.com

Abstract. Self-Compacting Concrete (SCC) is a concrete that can flow and compact by itself without vibrator. The ability of SCC to flow by itself makes this concrete very suitable for construction that has very small reinforcement gaps. In this study, SCC was designed to get a compressive strength above 60 MPa at the age of 28 days. Sugarcane bagasse ash was used as substitution material for cement replacement. Percentages of sugarcane bagasse ash used were 10%, 15%, and 20%. There were three w/c values that vary from 0.275, 0.300, and 0.325. Testing standards referred to ASTM, EFNARC and ACI. The fresh concrete test was slump flow, L-box and V-funnel. The maximum compressive strength was in the mixture with the sugarcane bagasse ash composition of 15% and w/c = 0.275 which was 67.24 MPa. The result of SEM test analysis found that the mixture composition with 15% sugarcane bagasse ash has solid CSH structure, small amount of pores, and smaller pore diameter than other mixtures.

4

INTRODUCTION

Self-Compacting Concrete (SCC) is a concrete that can flow by itself without vibrator and compact quickly. SCC is more liquid than conventional concrete but in the making process does not change the composition of the mixture on the percentage of water use. In the SCC making process there is no addition of water in the mixture composition but an admixture is added to the concrete mixture.

In the 1980s in Japan, SCC was produced at the University of Tokyo in collaboration with leading contractors for concrete manufacturing. Concrete is designed to flow through very small reinforcement gaps without bleeding and segregation. Superplasticizer becomes an additional material for the concrete to get a high slump [1].

SCC has several advantages compared to conventional concrete, for example reducing labors, equipments, and related costs, making faster construction process, enabling to fill complex formwork with very small reinforcement gaps, reducing the risk of accidents to workers, making more flexible design and detail of reinforcement [2]. In general, SCC materials are the same as conventional concrete, but in some cases it uses Viscosity-Modifying Admixture (VMA). SCC is described as a self-placing concrete, and self-leveling concrete, which is part of SCC [3].

Sugarcane bagasse ash is the result of combustion of sugarcane bagasse. Sugarcane bagasse ashes are used as industrial fuels at the sugarcane mills. The content of silica on bagasse ash is very high if the temperature and duration of combustion are controlled. Sugarcane bagasse ash can be a substitute material of cement because of sugarcane bagasse ash is included as pozzolan. The bagasse contents are about 50% cellulose, 25% hemicelluloses, and 25% lignin. The residue after combustion has silica dioxide (SiO₂) content [4]. The water cement factor is the ratio between the water content and cement used in the designed concrete composition. Water cement factor is often called w/c. The smaller w/c ratio obtains the higher result of compressive strength [5]. SCC is designed to pass

1

Proceedings of the 3rd International Conference on Construction and Building Engineering (ICONBUILD) 2017

AIP Conf. Proc. 1903, 050006-1–050006-10; <https://doi.org/10.1063/1.5011545>

Published by AIP Publishing, 978-0-7354-1591-1/\$30.00

050006-1

through the gap between reinforcement. This causes the aggregate size is very important to produce SCC. The smaller coarse aggregate size obtains the higher result of compressive strength [6].

Concrete is included in the SCC type when it is designed to meet the characteristics of filling ability, passing ability, viscosity, and segregation resistance. EFNARC sets the standard for fresh concrete testing as shown in Table 1. Slump flow is part of filling ability class test. J-ring and V-funnel are parts of fresh concrete tests to determine the viscosity class. L-box and U-box are parts of fresh concrete tests to determine the passing ability class.

TABLE 1. Test of fresh concrete [7]

Methods	Unit	Limitation	
		Min	Max
Slump flow	mm	650	800
30cm slump flow	Sec	2	5
J-ring	Mm	0	10
V-funnel	Sec	6	12
V-funnel at T5 minutes	Sec	0	3
L-box	-	0.8	1
U-box	mm	0	30
Fill-box	%	90	100
GTM Screen stability test	%	0	15
Orimet	Sec	0	5

MATERIALS AND METHODS

The composition of the SCC mixture in this study was with variations of w/c ratio and using the sugarcane bagasse ash (SCBA) as a substitute material. The variations of SCBA substitution were 0%, 10%, 15%, and 20% to the amount of cement. Variations of w/c ratio were w/c = 0.275, w/c = 0.300, and w/c = 0.325.

The materials used in this research were cement OPC (Ordinary Portland Cement) type I, water, fine aggregate from Tanjung Raja with size 0.125 – 4 mm and 50 – 650 μm , coarse aggregate with maximum size of 10 mm, admixture type F, and sugarcane bagasse ash.

Table 2 shows the results of chemical composition test of sugarcane bagasse ash (SCBA). The result of SCBA SEM test can be seen in Fig. 1. The used mixture compositions of SCC are listed in Table 3.

TABLE 2. SCBA chemical compositions

Chemical elements	Composition (%)
Silicon Dioxide (SiO_2)	83.40
Aluminum Oxide (Al_2O_3)	0.00
Iron (III) Oxide (Fe_2O_3)	5.00
Calcium Oxide (CaO)	2.38
Magnesium Oxide (MgO)	0.00
Sulfur Trioxide (SO_3)	0.61
LOI	8.36

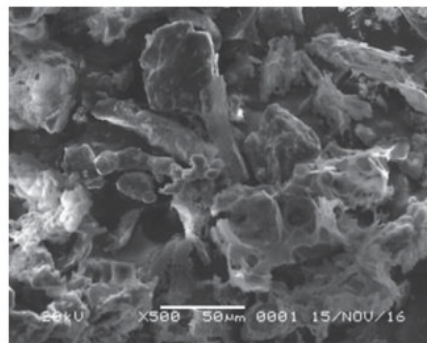

FIGURE 1. SEM test result of SCBA

TABLE 3. The compositions of 1m³ SCC

Label	OPC (kg)	SCBA (kg)	FA (kg)		CA (kg)	Water (kg)
			1	2		
SCC-0-0.275	600	0	246	540	823	165
SCC-0-0.300	600	0	246	540	823	180
SCC-0-0.325	600	0	246	540	823	195
SCC-10-0.275	570	30	246	540	823	165
SCC-10-0.300	570	30	246	540	823	180
SCC-10-0.325	570	30	246	540	823	195
SCC-15-0.275	540	60	246	540	823	165
SCC-15-0.300	540	60	246	540	823	180
SCC-15-0.325	540	60	246	540	823	195
SCC-20-0.275	510	90	246	540	823	165
SCC-20-0.300	510	90	246	540	823	180
SCC-20-0.325	510	90	246	540	823	195

The tests were slump flow test (Fig. 2), V-funnel test (Fig. 3), and L-box test (Fig. 4), then concrete compressive strength test at age 28 days, and concrete microstructure test with Scanning Electron Microscopy (SEM).

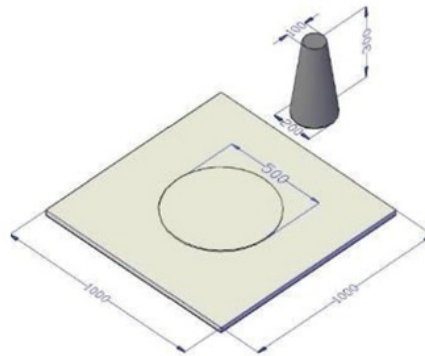

FIGURE 2. Slump flow test

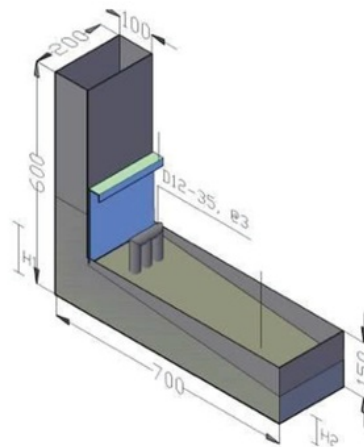

FIGURE 3. L-box test



FIGURE 4. V-Funnel test

1

RESULT AND DISCUSSION

The Result of Fresh Concrete Test

Slump flow

The results of slump flow test can be seen in Fig. 5 and Fig. 6. Fig. 5 shows the relationship between the percentage of sugarcane bagasse ash and slump flow. Figure 6 shows the relationship between the variation of w/c ratio and the slump flow. The value of slump flow was the result of the average of slump flow diameters from four directions. Based on the test results, the diameter of slump flow was range from 61.00 – 75.50 cm. The largest slump flow was at SCC-0-0.325 mixture, while the smallest slump flow was at SCC-20- 0.275 mixture.

The test results show that with the increase of the sugarcane bagasse ash composition, the slump flow diameter is smaller. This is because the sugarcane bagasse ash has a high water absorbing ability so that although the amount of water does not change for each w/c, the results of slump flow diameter are different. The smallest slump flow was in the mixture with SCBA 20%.

The results of slump flow test show that the higher w/c ratio is used, so the slump flow diameter is larger. This is because the water content increases so that the concrete mixture is easier to flow. The smallest slump flow diameter was found in the mixture with w/c = 0.275 and SCBA 20% of 61 cm.

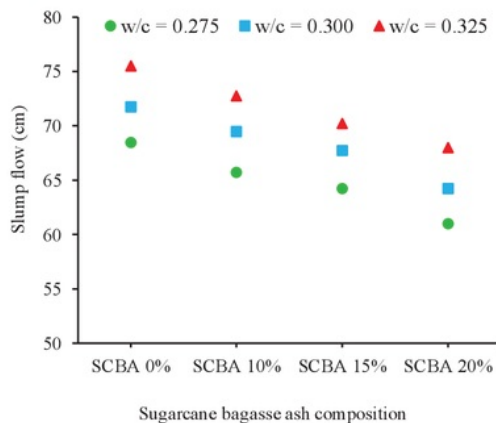

FIGURE 5. The effect of sugarcane bagasse ash composition on slump flow

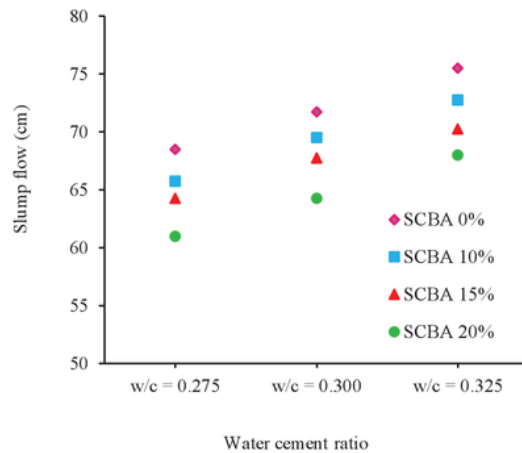

FIGURE 6. The effect of w/c variation on slump flow

V-funnel

V-funnel test results can be seen in Fig. 7 and Fig. 8. V-funnel values were obtained from the measurement of the time of fresh concrete to flow. V-funnel time ranged from 4.73 – 20.72 seconds. The fastest V-funnel time was found in the SCC-20-0.275 mixture while the longest was in SCC-0-0.325. Based on Fig. 7, it can be explained that as the sugarcane bagasse ash content increases, the V-funnel time becomes longer. This is because the bagasse ash has a high absorption rate so that the viscosity of concrete increases. Based on Fig. 8 it can be seen that with the increase of w/c ratio, the flowing time of V-funnel becomes faster. This is because the amount of water in the concrete increases, so the concrete viscosity decreases that makes the decreases of friction between particles in concrete mixture. The fastest V-funnel value was found in the mixture with w/c = 0.325.

L-shape box

5 The results of L-box test can be seen in Fig. 9 and 10. Fig. 9 shows the relationship between SCBA percentage and L-box test results. Fig. 10 illustrates the relationship between the variation of w/c ratio and the L-box test results. The L-box value was from the average measurements at the start of the body (H_1) and the end of the body (H_2) of L-box, each was carried out at three points. The ratio of L-box ranged from 0.74 to 1.00. The highest H_2/H_1 value was at SCC-0-0.325 of 1.00, while the lowest H_2/H_1 value was at SCC-20-0.275 of 0.74.

Based on Fig. 9, it can be explained that as the sugarcane bagasse ash content increases, the H_2/H_1 value becomes smaller. This is because with the increase sugarcane bagasse ash makes the concrete more viscous, so the concrete mixture is more difficult to flow through the gap between the reinforcement on the L-box tool. The highest H_2/H_1 value was present in the mixture with SCBA 0%. In Fig. 10, it can be explained that the higher value of w/c ratio makes the higher H_2/H_1 value. This is because the higher w/c ratio makes the concrete more fluid, so the concrete mixture is easier to flow through the gap between the reinforcement on the L-box tool. The highest H_2/H_1 value was present in the mixture with w/c = 0.325.

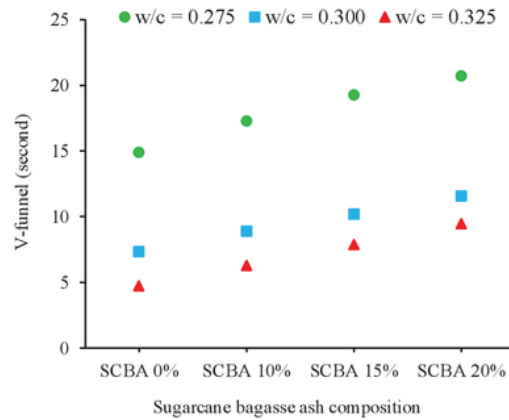

FIGURE 7. The effect of sugarcane bagasse ash composition on V-funnel

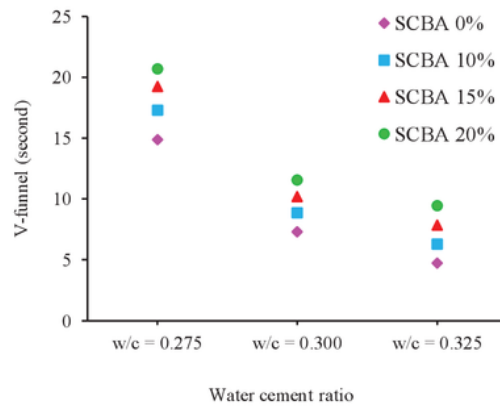

FIGURE 8. The effect of w/c variation on V-funnel

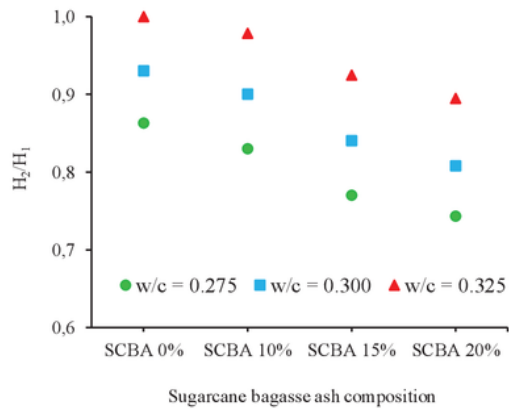

FIGURE 9. The effect of sugarcane bagasse ash composition on H_2/H_1 value

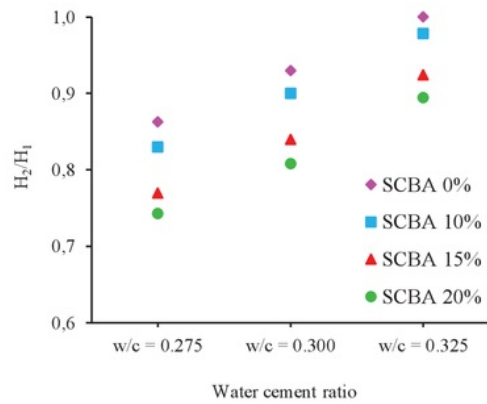

FIGURE 10. The effect of w/c variation on H₂/H₁ value

Compressive Strength

Fig. 11 shows the results of SCC compressive strength test based on SCBA composition, while Fig. 12 shows the SCC compressive strength test results based on the variation of w/c ratio.

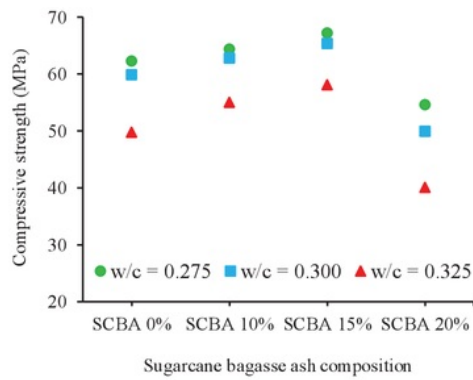

FIGURE 11. The effect of sugarcane bagasse ash composition on concrete compressive strength on age 28 days

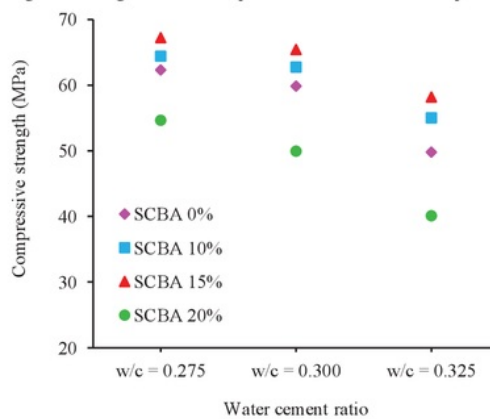

FIGURE 12. The effect of w/c variation on concrete compressive strength on age 28 days

Based on the results of the compressive strength test at age 28 days, the highest value of compressive strength was found in the SCC-15-0.275 mixture of 67.239 MPa, while the lowest compressive strength was in the SCC-20-0.325 mixture of 41.813 MPa. The test results showed that the addition of 15% sugarcane bagasse ash resulting the highest compressive strength. The addition of 15% sugarcane bagasse ash is the optimum percentage. In Fig. 11, it can be seen that the compressive strength decreases as the increase of w/c ratio. The lowest compressive strength was in the mixture with w/c = 0.325. Excess water content can form pores so that the bond between the pastes and the aggregate is weakened. This causes the compressive strength to decrease as the w/c ratio increases.

Microstructure Test

SEM samples were obtained from compressive strength test at age 28 days. SCC microstructure test results are shown in Fig.13 until 15. The result of the SCC SEM test with w/c = 0.275 is shown in Fig. 13. Fig. 13 shows that the CSH density continues to increase with the addition of the SCBA composition.

Figure 13 shows that CSH was formed and the pores varied in size but did not exceed 1 μm . CSH in the composition of SCBA = 0% looked less than other mixtures, besides that there were pores that less than 1 μm . In SCBA composition = 10%, CSH formed denser than CSH in SCBA = 0% composition. While on SCBA composition = 15% had denser CSH and smaller pores compared to other compositions.

The result of the SEM test with w/c = 0.300 is shown in Fig. 14. Based on the figure it can be seen that CSH was formed and the pores varied in size but not exceeding 1 μm . The pores formed on the mixture with w/c = 0.275 were lesser than the pores on the mixture w/c = 0.300. This is because the water percentage is lesser. In Fig. 14 (a) shows CSH appeared to had formed and there were pores less than 1 μm . In Fig. 14 (b) shows that the formed CSH appeared to be denser partially than Fig. 14 (a). In Fig. 14 (c) shows the densest formed CSH structure. In Fig. 14 (d) the CSH structure of the density decreased and the formed pores were larger than in Fig. 13 (d).

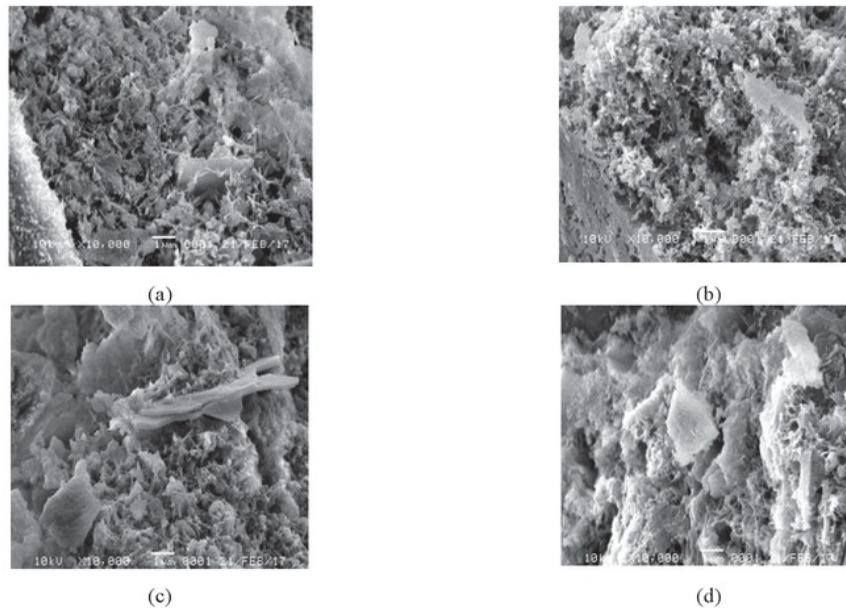

FIGURE 13. SCC microstructure with w/c = 0.275, (a) SCC-0-0.275, (b) SCC-10-0.275, (c) SCC-15-0.275, (d) SCC-20-0.275.

The result of the SEM test with w/c = 0.325 is shown by Fig. 15. Based on Fig. 15, CSH was already formed and the pores were various in size. The pore size formed on the mixture w/c = 0.325 was greater than the pore at w/c = 0.275 and w/c = 0.300. Larger pore size causes a decrease in strength. This is supported by concrete compressive strength result in Fig.11 and 12. The mixture with SCBA = 0% appeared to have the most dense CSH structure compared to the mixture with other SCBA compositions. In Fig. 15 (d) shows a micro crack groove that showed the

weakness of the bonds in SCC which is shown in Fig. 11 and 12 where the decrease of concrete compressive strength occurred in 10% SCBA composition and $w/c = 0.325$.

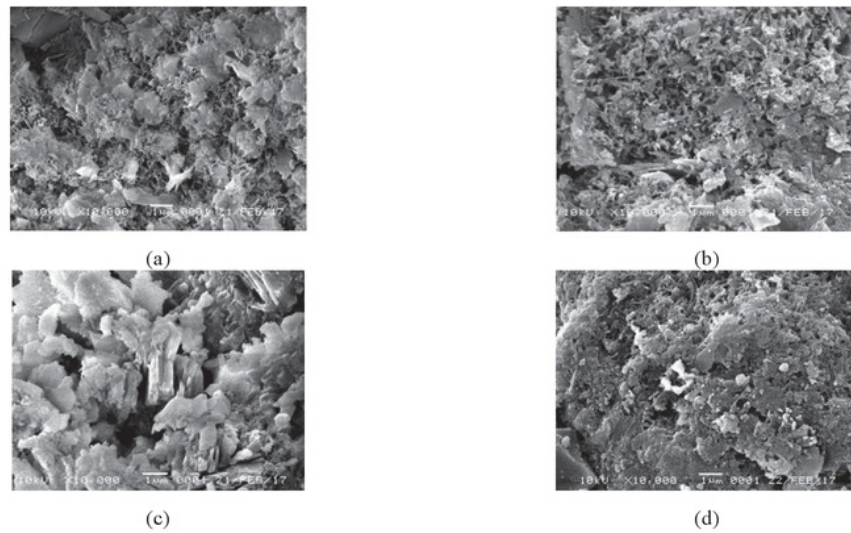

FIGURE 14. SCC microstructure with $w/c = 0.300$, (a) SCC-0-0.300, (b) SCC-10-0.300, (c) SCC-15-0.300, (d) SCC-20-0.300.

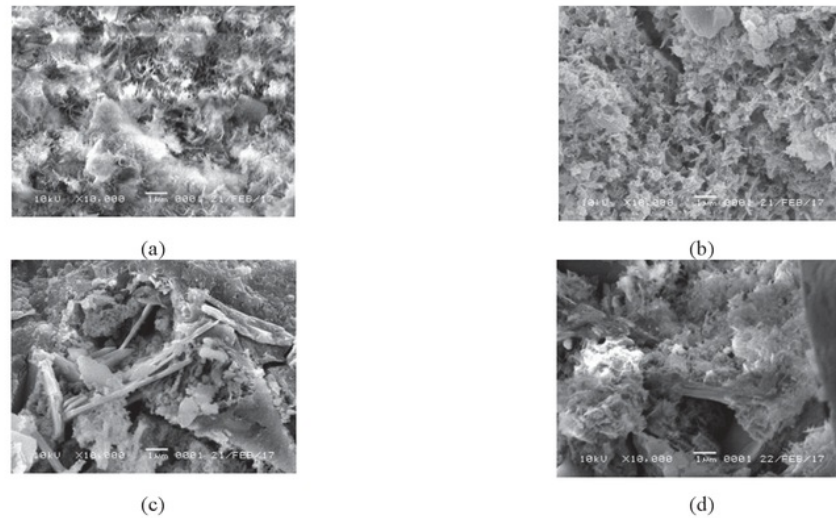

FIGURE 15. SCC microstructure with $w/c = 0.325$, (a) SCC-0-0.325, (b) SCC-5-0.325, (c) SCC-10-0.325, (d) SCC-15-0.325.

CONCLUSIONS

The conclusions obtained from the results of the study that has been done are as follows:

- The optimum composition of SCC mixture with SCBA substitution material showed the best performance on SCBA composition = 15%.
- The effects of w/c variation on workability, compressive strength of 28 days, and SCC microstructure are as follows:
 - The results of slump flow test on fresh concrete showed the largest diameter at SCC-0.325 which was 75.50 cm and the smallest diameter at SCC-0.275 which was 61.00 cm.

- The results of the V-funnel test on fresh concrete showed the fastest flowing time at SCC-0.325 was 4.73 seconds and the longest flowing time at SCC-0.275 was 20.72 seconds.
- The results of L-box test on fresh concrete showed the largest H_2/H_1 ratio at SCC-0.325 was 1.00 and the smallest H_2/H_1 ratio at SCC-0.275 was 0.74.
- The results of the 28 days compressive strength test, SCC with w/c ratio = 0.275 yielded the optimum compressive strength, as the increase of w/c ratio and SCBA, the compressive strength of concrete decreases. The compressive strength of SCC with w/c = 0.275 was 67.239 MPa.
- The pores formed on the mixture w/c = 0.275 were smaller than the pores formed on the mixture w/c = 0.300 and w/c = 0.325.
- The effects of bagasse ashes on workability, compressive strength of 28 days, and SCC microstructure are as follows:
 - The slump flow diameter and H_2/H_1 ratio decrease as SCBA composition increases.
 - The highest compressive strength was present in the mixture with w/c = 0.275 and the composition of SCBA = 15% of 67.239 MPa.
 - SCC with SCBA = 15% composition gives CSH structure that is more dense and has smaller pores compared to other compositions.

REFERENCES

1. M. S. Baig and M. M. Sadiq, IJERE, **3**, 52–55 (2016).
2. J. A. Daczko, *Self-Compacting Concrete, Applying What We Know* (Spon Press, New York, 2012).
3. ACI 237R-07, *Self-Consolidating Concrete* (American Concrete Institute, USA, 2007).
4. R. Srinivasan and K. Sathinaya, IJSLE, **5**, 60-66 (2010).
5. F. Burak, T. Selcuk, B. Baradan, IJBS, **42**, 1795–1802 (2007).
6. I. A. Kumar, IJSR, **5**, 1956–1958 (2016).
7. EFNARC Association. *The European Guidelines for Self-Compacting Concrete*. (United Kingdom, 2005).

The effect of w/c ratio on microstructure of self-compacting concrete (SCC) with sugarcane bagasse ash (SCBA)

ORIGINALITY REPORT

4%

SIMILARITY INDEX

%

INTERNET SOURCES

4%

PUBLICATIONS

%

STUDENT PAPERS

PRIMARY SOURCES

1

Ade Lisantono, Baskoro Abdi Praja, Billy Nouwen Hermawan. "Flexural strength of self compacting fiber reinforced concrete beams using polypropylene fiber: An experimental study", AIP Publishing, 2017

Publication

1%

2

K. K. Sideris, M. Konsta-Gdoutos. "Influence of the water to cement ratio W/C on the compressive strength of concrete ? An application of the cement hydration equation to concrete", Applied Composite Materials, 1996

Publication

1%

3

Hamid Eskandari-Naddaf, S. Muralidhara, B.K. Raghu Prasad, B.V. Venkatarama Reddy, Amir Pakzad. "PROPERTIES of SCC in GREEN and GREY STATE", Materials Today: Proceedings, 2018

Publication

1%

4

Siddique, R.. "Properties of self-compacting concrete containing class F fly ash", Materials

1%

5

Miguel C.S. Nepomuceno, L.A. Pereira-de-Oliveira, S.M.R. Lopes. "Methodology for the mix design of self-compacting concrete using different mineral additions in binary blends of powders", *Construction and Building Materials*, 2014

Publication

1%

Exclude quotes On

Exclude bibliography On

Exclude matches < 1%