

Differential-Drive Mobile Robot Control Design based-on.pdf

by

Submission date: 28-Mar-2022 10:28AM (UTC+0700)

Submission ID: 1794634913

File name: Differential-Drive Mobile Robot Control Design based-on.pdf (1,015.12K)

Word count: 3008

Character count: 15329

PAPER · OPEN ACCESS

² Differential-Drive Mobile Robot Control Design based-on Linear Feedback Control Law

² To cite this article: Siti Nurmaini *et al* 2017 *IOP Conf. Ser.: Mater. Sci. Eng.* **190** 012001

View [the article online](#) for updates and enhancements.

You may also like

- ⁵ - [Comparative analysis of driver's motion using different headrest positions during the rear-end collision](#)
Corbu Gheorghe Marius, Garnita Ionut Alexandru, Trusca Daniel Dragos et al.
- ⁴ - [Simulation and experiment analysis of dynamic deformation monitoring with the integrated GPS/pseudolite system](#)
Chao Liu, Jingxiang Gao, Xingwang Zhao et al.
- ⁶ - [An Improved Precise Positioning Method for Intelligent Mine Construction](#)
Kang Chen, Zhigang Du, Lin Guo et al.

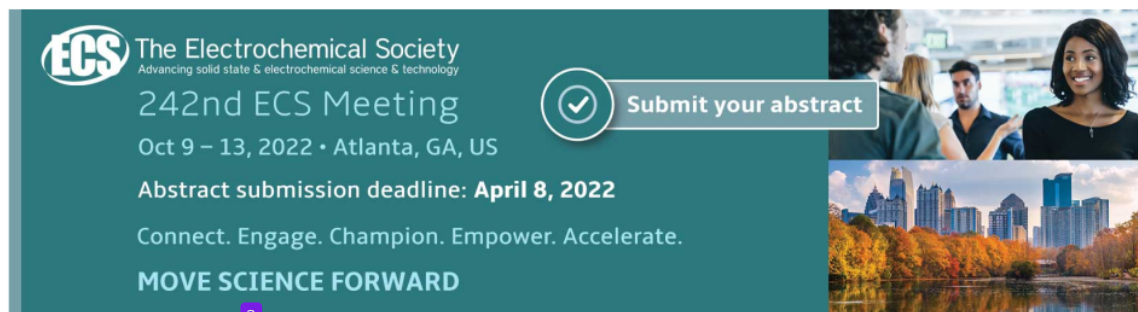

The Electrochemical Society
Advancing solid state & electrochemical science & technology



242nd ECS Meeting
Oct 9 – 13, 2022 • Atlanta, GA, US

Abstract submission deadline: **April 8, 2022**

Connect. Engage. Champion. Empower. Accelerate.

MOVE SCIENCE FORWARD



2

Differential-Drive Mobile Robot Control Design based-on Linear Feedback Control Law

Siti Nurmaini¹, Kemala Dewi², Bambang Tutuko³

^{1,2,3}Robotic and Control Research Lab. Computer Engineering Department,
Universitas Sriwijaya

¹ sitinurmaini@gmail.com, ² kemaladewi09@gmail.com, ³ tutukocn235@gmail.com,

Abstract. This paper deals with the problem of how to control differential driven mobile robot with simple control law. When mobile robot moves from one position to another to achieve a position destination, it always produce some errors. Therefore, a mobile robot requires a certain control law to drive the robot's movement to the position destination with a smallest possible error. In this paper, in order to reduce position error, a linear feedback control is proposed with pole placement approach to regulate the polynoms desired. The presented work leads to an improved understanding of differential-drive mobile robot (DDMR)-based kinematics equation, which will assist to design of suitable controllers for DDMR movement. The result show by using the linier feedback control method with pole placement approach the position error is reduced and fast convergence is achieved.

1

1. Introduction

According to various studies that have been conducted, mobile robot control system can be classified into three categories. The first category is namely the sensor-based control-based approach. Such control system is emphasized on how to model the motion of a robot in a dynamic environment [1]. The control process to produce estimation and predictions of the mobile robot movement is based on information from sensor detection [2]. The intelligent control scheme is an approach that is most widely used [3][4][5]. However, its results produce sub-optimal response, because the motion is only around the trajectory detection [5]. The second category is the approach of decomposed execution process using a path planning [6][7]. The control system regulates the movement of the mobile robot through the planned path, therefore it can move according to the target that has been set up. The environmental mapping is created for producing collision-free path. Such scheme of control is based on minimal distance, energy and time. The third category presenting the optimization algorithm is developed for controlling the mobile robot with accurate trajectory. The controller design is based on mathematical model of mobile robot. The approach is for tracking the mobile robot errors between reference and actual trajectory [8][9].

However, the whole categories of the control system only operate when the condition of linear velocity is not zero. Therefore, a mobile robot is difficult to control, especially in the case of following the reference of trajectory in a short time with minimal errors. Nonlinear control approaches have been employed to solve this problem [10][11][12][13]. Although the regulation problem is solved to track the mobile robot move to desired trajectory, but it found to yield slow asymptotic convergence [13]. In order to obtain faster convergence, an alternative approach must be proposed. This paper proposes the linier feedback control law to overcome such limitation with pole placement approach to regulate the



1
 polynom desired. By using the scheme, the controller performance can be regulated and fast asymptotic convergence is achieved.

2. Differential Drive Mobile Robot Kinematic Model

The differential-drive mobile robot (DDMR) is a class of computer-controlled vehicles whose motion can be described or transformed into the following model with constrained movement in a plane. Figure 1 describes the DDMR on 2D-cartesian plane, it means the mobile robot move only in the x axis, while the contour and elevation of the z -axis is ignored [13].

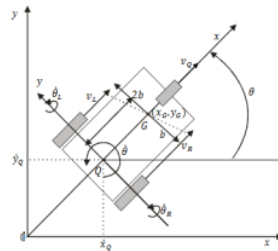

Figure 1. DDMR on 2D cartesian plane

From Figure 1, the representation of \dot{x}_Q, \dot{y}_Q are x, y coordinate relation to center of the robot Q , v_Q is a linier velocity, v_L are linier velocity of left wheels and v_R linier velocity of right wheel, r is a radius of wheel, $2b$ is a distance from right to left wheel, Q is a center point of the robot, G is a center of gravitation and b is a distance between 2 wheels with G . By ignoring the analysis of the castor-free, the configuration of the mobile robot can be described into three general variables $q(t)$ to describe the position of the robot and the control input $u(t)$. It can be defined in matrix:

$$q(t) = (x(t), y(t), \theta(t))^T, \text{ and } u(t) = (\dot{\theta}_R(t), \dot{\theta}_L(t))^T \quad (1)$$

The angular velocity equations for the right wheel and left wheel such as,

$$\dot{\theta}_R(t) = \frac{1}{2\pi r} \cdot v_R(t); \dot{\theta}_L(t) = \frac{1}{2\pi r} \cdot v_L(t) \quad (2)$$

$$v_R(t) = v(t) + b\dot{\theta}(t); v_L(t) = v(t) - b\dot{\theta}(t) \quad (3)$$

From equations (2) and (3) above, a linear velocity equation is $v_Q(t)$ and an angular velocity equation is $\dot{\theta}(t)$ as follow,

$$v_Q(t) = \frac{1}{2}(v_R(t) + v_L(t)); \dot{\theta}(t) = \frac{v_R(t) - v_L(t)}{2b} \quad (4)$$

However, the DDMR has a limitation in terms of movement, due to the non-holonomik constraint. The constrained are obtained by two main assumptions. The first assumption no lateral slip motion. It's mean the robot can move only in a curved motion (forward and backward) but not sideward. The velocity equation at the midpoint of the both wheels (G) is obtained by using Figure 2(b), the equation is described as follows,

$$v(t) = \dot{x}(t) \cos \theta(t) + \dot{y}(t) \sin \theta(t) \quad (5)$$

1 In the robot frame, this condition means the velocity of the wheel in the centre point G is zero along the lateral axis and it's only move along x axis and y axis [7]. Therefore, the velocity equation gives,

$$\dot{x}(t) \sin \theta(t) - \dot{y}(t) \cos \theta(t) = 0 \quad (6)$$

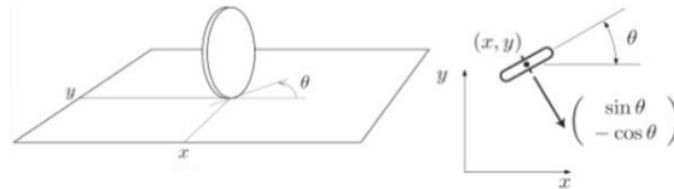

Figure 2. No lateral slip

The second assumption is the pure rolling constraint, due to the wheels do not slip on the floor and has limitations of pure rolling (Figure 3). The velocities of the contact points in the robot frame are related to the wheel velocities for the right wheel and left wheel gives,

$$v_R(t) = r\dot{\theta}_R(t) \text{ and } v_L(t) = r\dot{\theta}_L(t) \quad (7)$$

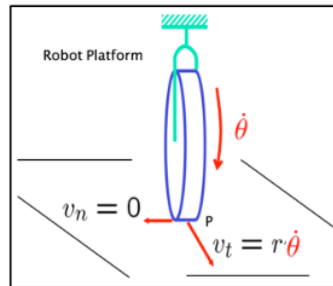

Figure 3. Pure rolling motion constraint

By looking at the starting position of the wheel to the Cartesian field xy can be obtained the equation of position wheeled robot, $x(t) = v(t) \sin \theta(t)$, $y(t) = v(t) \cos \theta(t)$, and $\theta(t) = v_{\theta}(t)$. Thus, the transformation matrix equations from the initial position can be defined as,

$$T_{NH}(q) = \begin{bmatrix} \frac{r}{2} \cos \theta(t) & \frac{r}{2} \cos \theta(t) \\ \frac{r}{2} \sin \theta(t) & \frac{r}{2} \sin \theta(t) \\ \frac{r}{2b} & -\frac{r}{2b} \end{bmatrix} \quad (8)$$

1 Furthermore **1** the angular velocity $u(t)$ as input to the robot have three parameters such as, $u_1(t) = \dot{\theta}_R(t)$, $u_2(t) = \dot{\theta}_L(t)$, and $\dot{\theta}(t) = \omega(t)$. From equation (8) and three parameters of input equation, the model of DDMR kinematic equation is, $\dot{q}(t) = T_{NH}(q) u(t)$ or,

$$\begin{bmatrix} \dot{x}(t) \\ \dot{y}(t) \\ \dot{\theta}(t) \end{bmatrix} = \begin{bmatrix} \cos \theta(t) & 0 \\ \sin \theta(t) & 0 \\ 0 & 1 \end{bmatrix} \begin{bmatrix} v(t) \\ \omega(t) \end{bmatrix} \quad (9)$$

3. The Error Model of DDMR Movement

The error model of DDMR is obtained by reducing the reference position $q_r(t) = (x_r(t), y_r(t), \theta_r(t))^T$ with the actual position of the robot $q_c(t) = (x_c(t), y_c(t), \theta_c(t))^T$. The visualisation of DDMR movement is presented in Figure 4. Thus, the error of mobile robot movement is represented by $q_e(t) = (e_1(t), e_2(t), e_3(t))^T$. $q_e(t)$ is the transformation result between the reference position $q_r(t)$ in a local coordinate system with the previous position $q_c(t)$ and X axis which is the direction toward the robot is $\theta_c(t)$ or $q_e(t) = T_e(q_r(t) - q_c(t))$. It can be realized in equation (10) as follows:

$$\begin{bmatrix} e_1(t) \\ e_2(t) \\ e_3(t) \end{bmatrix} = \begin{bmatrix} \cos \theta_c(t) & \sin \theta_c(t) & 0 \\ -\sin \theta_c(t) & \cos \theta_c(t) & 0 \\ 0 & 0 & 1 \end{bmatrix} \begin{bmatrix} x_r(t) - x_c(t) \\ y_r(t) - y_c(t) \\ \theta_r(t) - \theta_c(t) \end{bmatrix} \quad (10)$$

By lowering the equation (10) and involving the equations that exist in the equation of non-holonomic DDMR constraints, the error equation is obtained as equation (11) below:

$$\begin{bmatrix} \dot{e}_1(t) \\ \dot{e}_2(t) \\ \dot{e}_3(t) \end{bmatrix} = \begin{bmatrix} \cos e_3(t) & 0 \\ \sin e_3(t) & 0 \\ 0 & 0 & 1 \end{bmatrix} \begin{bmatrix} v_r(t) \\ \omega_r(t) \end{bmatrix} + \begin{bmatrix} -1 & e_2(t) \\ 1 & -e_1(t) \\ 0 & -1 \end{bmatrix} \begin{bmatrix} v_c(t) \\ \omega_c(t) \end{bmatrix} \quad (11)$$

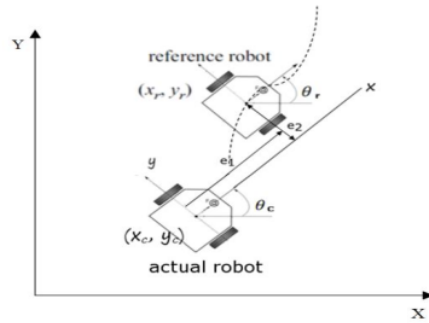

Figure 4. Transformation of error movement

From equation (11), $v_r(t)$ as a reference linear velocity, $\omega_r(t)$ as a reference angular velocity, $v_c(t)$ as an actual linear velocity, and $\omega_c(t)$ as an actual angular velocity. In this model the combination between feed forward control and linier feedback control based on pole placement approach is proposed, therefore a new input is created below,

$$\begin{aligned} v_c(t) &= v_{ff}(t) - v_1(t) \\ v_c(t) &= v_r(t) \cos e_3(t) - v_1(t) \end{aligned} \quad (12)$$

$$\begin{aligned} \omega_c(t) &= \omega_{ff}(t) - v_2(t) \\ \omega_c(t) &= \omega_r(t) - v_2(t) \end{aligned} \quad (13)$$

By substituting equation (12) and (13) into equation (11) nonlinear equation of error control velocity is obtained,

$$\begin{bmatrix} \dot{e}_1(t) \\ \dot{e}_2(t) \\ \dot{e}_3(t) \end{bmatrix} = \begin{bmatrix} 0 & \omega_c(t) & 0 \\ -\omega_c(t) & 0 & 0 \\ 0 & 0 & 0 \end{bmatrix} \begin{bmatrix} e_1(t) \\ e_2(t) \\ e_3(t) \end{bmatrix} + \begin{bmatrix} 0 \\ \sin e_3(t) \\ 0 \end{bmatrix} v_r(t) + \begin{bmatrix} 1 & 0 \\ 0 & 0 \\ 0 & 1 \end{bmatrix} \begin{bmatrix} v_1(t) \\ v_2(t) \end{bmatrix} \quad (14)$$

By using the linearization approach around its operating point (OP : $e_1 = e_2 = e_3 = 0, v_1 = v_2 = 0$). Thus, the linear model of error in equation (14) become,

$$\Delta \dot{e}(t) = \begin{bmatrix} 1 & 0 & 0 \\ 0 & \omega_r(t) & 0 \\ 0 & 0 & 0 \end{bmatrix} \cdot \Delta e(t) + \begin{bmatrix} 1 & 0 \\ 0 & 0 \\ 0 & 1 \end{bmatrix} \cdot \Delta v(t) \quad (15)$$

4. Control System Design

In this research, the controller design has three states, namely $x(t)$, $y(t)$, and $\theta(t)$ and two inputs, namely $v(t)$, and $\omega(t)$. The general equation linear state space controller. $v(t) = K \cdot e(t)$, therefore the feedback control law becomes

$$\begin{bmatrix} v_1(t) \\ v_2(t) \end{bmatrix} = \begin{bmatrix} -k_1 & 0 & 0 \\ 0 & -\text{sign}(v_r(t))k_2 & -k_3 \end{bmatrix} \begin{bmatrix} e_1(t) \\ e_2(t) \\ e_3(t) \end{bmatrix} \quad (16)$$

From equation (16) a linear velocity of robot $v(t)$ replaced by $v_1(t)$, an angular velocity of robot $\omega(t)$ replaced by $v_2(t)$, some values of k_1 , k_2 , and k_3 are a gain in the controller. The diagram block of the control system design can be seen in Figure 4. Moreover, the value of k control law corresponding will be determined. This problem is solved by optimizing some function value. In this research, the determination of the k value is determined by comparing the characteristics of the real polynomials and desired polynomials of control system characteristics [5]. These polynomials take the following form as follow,

$$(s + 2\zeta\omega_n)(s^2 + 2\zeta\omega_n s + \omega_n^2) \text{ and } s^3 + (4\zeta\omega_n)s^2 + (4\zeta^2\omega_n^2 + \omega_n^2)s + 2\zeta\omega_n^3 \quad (17)$$

Where, two parameters are selected such as, the damping coefficient $\zeta \in (0,1)$ and the natural frequency $\omega_n > 0$. At the additional pole $s = -2\zeta\omega_n$ which is useful to increases the rise time and to reduce the overshoot system. The polynomial characteristic of the closed loop control law in equation (15) with input to the state space controller in equation (16) are the two important parameters design. All equations from (8) to (16) can be visualized as a block diagram with linier feedback control law as shown in Figure 5.

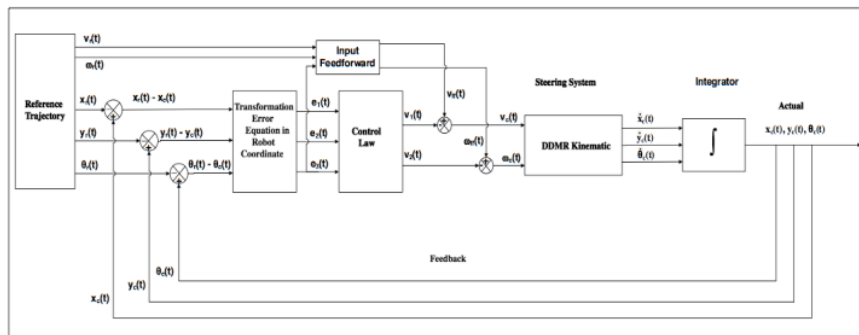

Figure 5. Block diagram control law of DDMR system

5. Simulation Results

The purpose of this research is to find the parameters of error value including $x(t)$, $y(t)$ and $\theta(t)$ based on polynomials approach to produce good control performance such as, rise time, and steady state error parameters. Some simulations are conducted to show the DDMR performance in terms of error and delta error values by using the proposed control law. The starting position of the robot at coordinates is set at (0; 0; 0.78) and initial linear velocity is set at 0,01 m/s and angular velocity is set at 0,02 rad/s. Therefore, it can be calculated to obtain the value of the average error and time to steady

2 state. Initial performance of controller are the damping factor and natural frequency. The damping factor is set variable from $0,2 < \zeta < 0.8$ and natural frequency are set at $\omega_n = 5$, $\omega_n = 2$, and $\omega_n = 1$ respectively. The error position of DDMR based on selected parameter as shown in Figure 6.

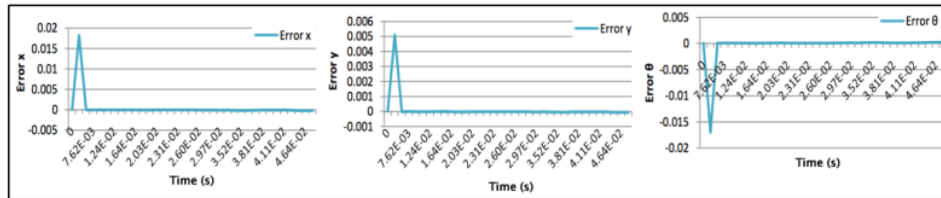

Figure 6. The DDMR error position control

The summary all experiments for DDMR movement in simulation process is described in Table 1 and Table 2.

Table 1. (a) Comparison data of average error value with $0,2 < \zeta < 0.8$ and ω_n is fixed

(b) Comparison data of the average interval time with $0,2 < \zeta < 0.8$ ω_n is fixed

No	ζ	ω_n	g	k_1	k_2	k_3	Average of error			No	ζ	ω_n	g	k_1	k_2	k_3	Average of Δt		
							Δx	Δy	$\Delta \theta$								$e_1(t)$	$e_2(t)$	$e_3(t)$
1	0.2	2	1	0.8	0.8	0.8	2.8×10^{-3}	1.4×10^{-3}	-3×10^{-3}	1	0.2	2	1	0.8	0.8	0.8	7×10^{-2}	7×10^{-2}	7×10^{-2}
2	0.3	2	1	1.2	0.8	1.2	-4×10^{-3}	-2×10^{-3}	4.9×10^{-3}	2	0.3	2	1	1.2	0.8	1.2	2.8×10^{-1}	2.8×10^{-1}	2.8×10^{-1}
3	0.4	2	1	1.6	0.8	1.6	-3×10^{-3}	-10^{-3}	4×10^{-3}	3	0.4	2	1	1.6	0.8	1.6	2.4×10^{-1}	2.4×10^{-1}	2.4×10^{-1}
4	0.5	2	1	2	0.8	2	3×10^{-4}	7×10^{-5}	-2×10^{-4}	4	0.5	2	1	2	0.8	2	3.3×10^{-2}	3.3×10^{-2}	3.3×10^{-2}
5	0.6	2	1	2.4	0.8	2.4	4×10^{-4}	10^{-4}	-4×10^{-4}	5	0.6	2	1	2.4	0.8	2.4	2.5×10^{-2}	2.5×10^{-2}	2.5×10^{-2}
6	0.7	2	1	2.8	0.8	2.8	-7.3×10^{-4}	-2.1×10^{-4}	7.7×10^{-4}	6	0.7	2	1	2.8	0.8	2.8	8.7×10^{-2}	8.7×10^{-2}	8.7×10^{-2}
7	0.8	2	1	3.2	0.8	3.2	10^{-4}	2×10^{-5}	-9.6×10^{-5}	7	0.8	2	1	3.2	0.8	3.2	3.6×10^{-2}	3.6×10^{-2}	3.6×10^{-2}

In table 1(a) and 1(b), it can be seen the value of the error and the smallest travel time obtained by setting the value of $\zeta = 0.6$. In Table 2, it compared with the test data in value $\zeta = 0.6$, $\omega_n = 2$, and $g = 1$ before, the delta error value and the smallest interval time are obtained by assigning a value $\omega_n = 2$.

Table 2. Comparison data of the average error value and time interval with $\omega_n = 5$, $\omega_n = 2$, and $\omega_n = 1$ and ζ is fixed

No.	ζ	ω_n	g	k_1	k_2	k_3	Average of Δe			Average of Error time		
							x	y	θ	x	y	θ
1	0.6	5	1	0.8	0.8	0.8	1.2×10^{-3}	1.7×10^{-4}	-9.3×10^{-4}	3.5×10^{-2}	3.5×10^{-2}	3.5×10^{-2}
2	0.6	2	1	2.4	0.8	2.4	4×10^{-4}	10^{-4}	-4×10^{-4}	2.5×10^{-2}	2.5×10^{-2}	2.5×10^{-2}
3	0.6	1	1	1.2	0.8	1.2	2×10^{-4}	8×10^{-5}	-2×10^{-4}	5×10^{-2}	5×10^{-2}	5×10^{-2}

6. Conclusion

From the experimental results, it is concluded that the method of linearization error with feed-forward and feedback control law with poles placement approach produces small value of the average error

2 position, and it achieved in a short time to steady state condition. From Seven values of ζ and two values of ω_n , are selected $\zeta = 0.6$, $\omega_n = 2$, and $g = 1$, due to by using the values it can be obtained the average value of delta error is 4×10^{-4} m on x position; the average value of delta error is 10^{-5} m on y position and the average value of delta error of direction side of the robot is -4×10^{-4} rad with an average time interval is 2.5×10^{-2} s. By regulating performance of controller based on pole placement approach, the small error, faster time to steady state and small overshoot is achieved.

Acknowledgments

The Authors thank The Ministry of Technology Research and Higher Education (Kemenristek-Dikti), Indonesia and Universitas Sriwijaya for their financial support in Excellence University Research Project or Penelitian Unggulan Perguruan Tinggi (PUPT)

References

- [1] Fiorini, P., & Shiller, Z. (1998). Motion planning in dynamic environments using velocity obstacles. *The International Journal of Robotics Research*, 17(7), 760-772.
- [2] Elfes, A. (1989). Using occupancy grids for mobile robot perception and navigation. *Computer*, 22(6), 46-57.
- [3] Fierro, R., & Lewis, F. L. (1998). Control of a nonholonomic mobile robot using neural networks. *IEEE transactions on neural networks*, 9(4), 589-600.
- [4] Hu, H., & Brady, M. (1996). A parallel processing architecture for sensor-based control of intelligent mobile robots. *Robotics and autonomous systems*, 17(4), 235-257.
- [5] Ge, Shuzhi S., and Yun J. Cui. "Dynamic motion planning for mobile robots using potential field method." *Autonomous Robots* 13.3 (2002): 207-222.
- [6] Salomon, B., Garber, M., Lin, M. C., & Manocha, D. (2003, April). Interactive navigation in complex environments using path planning. In *Proceedings of the 2003 symposium on Interactive 3D graphics* (pp. 41-50). ACM.
- [7] Yang, J. M., & Kim, J. H. (1999). Sliding mode control for trajectory tracking of nonholonomic wheeled mobile robots. *IEEE Transactions on Robotics and Automation*, 15(3), 578-587.
- [8] Hoffmann, G. M., Tomlin, C. J., Montemerlo, M., & Thrun, S. (2007, July). Autonomous automobile trajectory tracking for off-road driving: Controller design, experimental validation and racing. In *American Control Conference* (pp. 2296-2301).
- [9] Lee, T. C., Song, K. T., Lee, C. H., & Teng, C. C. (2001). Tracking control of unicycle-modeled mobile robots using a saturation feedback controller. *IEEE transactions on control systems technology*, 9(2), 305-318.
- [10] Fierro, R., & Lewis, F. L. (1995, December). Control of a nonholonomic mobile robot: backstepping kinematics into dynamics. In *Decision and Control, 1995., Proceedings of the 34th IEEE Conference on* (Vol. 4, pp. 3805-3810). IEEE.
- [11] Yang, H., Fan, X., Shi, P., & Hua, C. (2016). Nonlinear Control for Tracking and Obstacle Avoidance of a Wheeled Mobile Robot With Nonholonomic Constraint. *IEEE Transactions on Control Systems Technology*, 24(2), 741-746.
- [12] Huang, J., Wen, C., Wang, W., & Jiang, Z. P. (2014). Adaptive output feedback tracking control of a nonholonomic mobile robot. *Automatica*, 50(3), 821-831.
- [13] Dhaouadi, Rached, and Ahmad Abu Hatab. "Dynamic modelling of differential-drive mobile robots using lagrange and newton-euler methodologies: A unified framework." *Advances in Robotics & Automation* 2013.

Differential-Drive Mobile Robot Control Design based-on.pdf

ORIGINALITY REPORT

84%

SIMILARITY INDEX

78%

INTERNET SOURCES

80%

PUBLICATIONS

22%

STUDENT PAPERS

PRIMARY SOURCES

- 1** Siti Nurmaini, Kemala Dewi, Bambang Tutuko. "Differential-Drive Mobile Robot Control Design based-on Linear Feedback Control Law", IOP Conference Series: Materials Science and Engineering, 2017
Publication **44%**
- 2** journal.portalgaruda.org
Internet Source **30%**
- 3** Submitted to Sriwijaya University
Student Paper **8%**
- 4** Ting-Hua Yi, Hong-Nan Li, Ming Gu. "Characterization and extraction of global positioning system multipath signals using an improved particle-filtering algorithm", Measurement Science and Technology, 2011
Publication **1%**
- 5** Corbu Gheorghe Marius, Garnita Ionut Alexandru, Trusca Daniel Dragos, Toma Florin Daniel. "Comparative analysis of driver's motion using different headrest positions during the rear-end collision", IOP Conference

Series: Materials Science and Engineering,
2022

Publication

6

W Jiang, Z L Liu, Y C Wang, J G Yang, G Y Hou.
"Numerical Investigation of the Clocking Effect
on the Centrifugal Pump as Turbine", IOP
Conference Series: Earth and Environmental
Science, 2021

Publication

1 %

7

Klancar, G.. "Tracking-error model-based
predictive control for mobile robots in real
time", Robotics and Autonomous Systems,
20070630

Publication

<1 %

Exclude quotes On

Exclude matches Off

Exclude bibliography On